

SEGA®

COMIX
ZONE™

GENESIS™

INSTRUCTION MANUAL



KIDS TO ADULTS



AGES 6+

Artist's Profile



Name: *Sketch Turner*

Occupation: WRITER / ARTIST ON COMIX ZONE, FREELANCE ROCK MUSICIAN

Current residence: A WAREHOUSE STUDIO / LOFT KIND OF PLACE IN THE BOWERY (THAT'S IN NEW YORK CITY!)

My best friend: ROADKILL, MY PET RAT, WHO I SAVED FROM CERTAIN DOOM IN A GARBAGE TRUCK -- I LOVE THIS LITTLE CREEP!

When I'm not working, I like to: PLAY EAR-DEAFENING GUITAR, MICROWAVE PIZZA, READ TRASHY SCI-FI NOVELS, PLAY SONIC SPINBALL AND TRAIN ROADKILL -- I NEED A VACATION!

I'm most proud of: THE ISSUE OF COMIXZONE I'M WORKING ON NOW, WHERE THE NEW WORLD EMPIRE FINALLY FACES MORTUS!

My main influence in creating Comix Zone: I KIND OF HAD THESE NIGHTMARES, SOME REALLY FRIGHTENING STUFF, AND I THOUGHT, "HEY, THIS WOULD MAKE A GREAT COMIC BOOK!"

Best/worst part of doing Comix Zone: HEARING FROM ALL THE FANS WHO DIG THE BOOK IS DEFINITELY THE BEST PART. THE WORST PART, I GUESS IS THAT SOMETIMES I GET THIS SCARY FEELING THAT THERE'S MORE TO COMIXZONE THAN IT SEEMS -- AS IF IT ALL WAS REALLY HAPPENING, LIKE IN ANOTHER DIMENSION OR SOMETHING. IT REALLY FREAKS ME OUT...

COMIX ZONE

NEW YORK CITY -
THE DECEASED DISTRICT.
A ROUTINE PATROL
HAS ENDED IN AN
ASSASSINATION ATTEMPT
ON GENERAL
ALISSA CYAN...

STAND YER GROUND,
TOBOL! LET'S SHOW
THIS NIGHTMARE
LEGION WHAT THE
N.W.E.* IS MADE
OF!

SKRAAK



* NEW WORLD
EMPIRE - SKETCH



SHUT YER YAP AN'
SHAKE YER TAIL, TOBOL!
WE JUST GOTTA HOLD ON
TIL THAT BLASTED
GRAYJET GETS HERE!

OH, NO PROBLEM,
I'LL JUST SIT HERE AND
SUN MYSELF!





LATER, AT THE
PALACE HEADQUARTERS
OF THE NEW
WORLD EMPIRE...

YER CRAZY! ALL
I'M ASKIN FOR IS
ONE MAN. AN'
YOU REFUSE TO
ACT?!

NEW WORLD EMPIRE

YOUR EMPEROR IS
NOT CRAZY, GENERAL
CYAN. HE MERELY SEEKS
TO PRESERVE THE HARD-
WON PEACE THAT SHINES
LIKE THE SUN OVER
OUR LANDS!

TOO BAD
TOBOL'S NOT
AROUND TO BASK
IN YER "HARD-
WON PEACE."

NEED YOUR
EMPEROR REMIND
YOU AGAIN,
GENERAL CYAN,
OF OUR UNFOR-
TUNATE PAST?..

NEW

"THE GREAT METEOR DISASTER OF 1998 NEARLY DESTROYED ALL CIVILIZATION AS WE KNOW IT. THE SURVIVORS OF OUR WORLD ENGAGED IN PETTY SQUABBLES AND BATTLES FOR LAND. FORTUNATELY, THE FATES CONSPIRED TO PRODUCE ONE SHINING BEACON OF HOPE FOR THEM ALL, ONE MAN TO UNIFY AND UNITE THE MASSES UNDER A FLAG OF PEACE, LOVE AND UNDERSTANDING..."

KRAAKIA-THOOM!

"HEH!"

WHAT'S SO FUNNY ABOUT THAT?!

IT'S FUNNY 'CAUSE I HAVE HEARD ALL THIS BEFORE! BUT THE JOKE'LL BE ON US UNLESS WE PUT THE KIBOSH ON THIS MORTUS CREEP AND HIS RENEGADE SYNDICATE!



AND I SUPPOSE THIS "LONE OPERATIVE" OF YOURS IS THE SOLUTION TO THE THREAT OF THE SUPPOSED MORTUS AND HIS "RENEGADES" THAT ONLY YOU AND YOUR UNFORTUNATE ASSISTANT HAVE SEEN?



MY EMPEROR! REPORTS OF A RENEGADE ATTACK ON TIBET CITY!

MY EMPEROR! RECONNAISSANCE SHOWS SOME SORT OF "DOOMSDAY DEVICE" LOCATED OFF THE ZEALAND ATOLLS! AND WE HAVE PHOTOS!

PHOTOS OF HORRIBLE MUTANTS!



YOU CAN SIT ON YER THRONE AN' JAW ALL DAY LONG, YER HIGHNESS -- BUT THERE'S A STORM COMIN' AN SOMEBODY'S GOTTA CLOSE THE SHUTTERS!

PATIENCE AND FAITH WILL SEE US THROUGH, GENERAL! -- DON'T DEFY YOUR EMPEROR!

SHORTLY THEREAFTER,
ABOARD THE N.W.E.'S
MOBILE SKY HEAD-
QUARTERS...

EMPEROR'S OFF
HIS @#%* ROCKER!
MAYBE IT IS "DE-
FYING ORDERS,"
BUT I'LL GET MY
SPECIAL AGENT...

GENERAL!
MORE IN-
TELLIGENCE
ON THOSE...

... MUTANTS
SPOTTED
OFF THE
COAST OF...

... ZEALAND
REPORTS MORE
ACTIVITY
IN...

... 'CAUSE I DON'T
NEED BLASTED SE-
CURITY REPORTS
TO TELL ME THERE'S
A CONSPIRACY
HERE, OR THAT IT'S
LED BY...





CONTENTS

Starting Up	10
Options	11
Play Controls	12
Basic Moves	13
Fighting Moves	14
Survive Comix Zone!	18
The Screen	19
Inventory Items	20
Mutant Hit List	22
Episodes	25
Credits	26



STARTING UP



1. Set up your Genesis System, following the instructions in the Genesis manual.
2. Make sure the power switch is turned OFF.
3. Plug a control pad into Control Port 1.
4. Fit the game cartridge into the cartridge slot and press it down FIRMLY.
5. Turn the power switch ON.
6. When the Title screen appears, press **Start** on the control pad to witness Sketch plunging into the pages of his own comic!

IMPORTANT —

Always turn the power switch OFF before inserting or removing the game cartridge.

OPTIONS

1. At the Title screen, use the **D-Pad** to highlight Options and then press **Start**.

2. Highlight a category on the Options screen and press **Start**

3. Use the **D-Pad** to highlight different options and move through their settings.

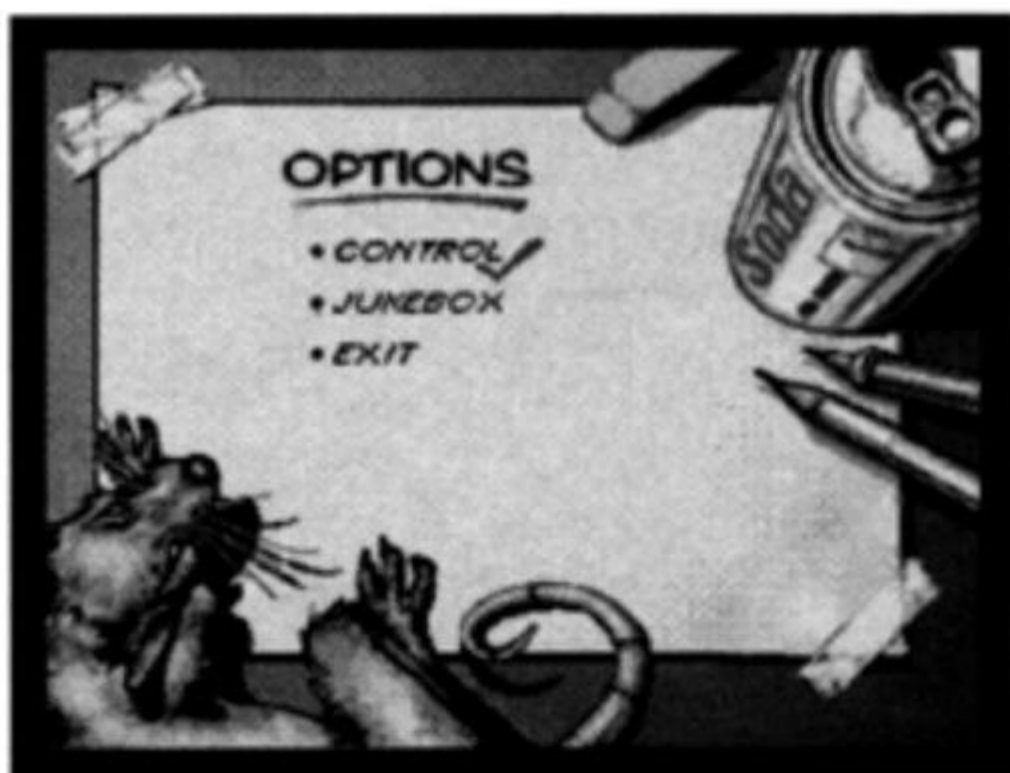

CONTROL

- Configure the **Action, Jump and Select/Custom buttons.**

- Assign a Custom Move (BLOCK or any of the SPECIAL MOVES)

when using a Sega 6-Button Arcade Pad™.

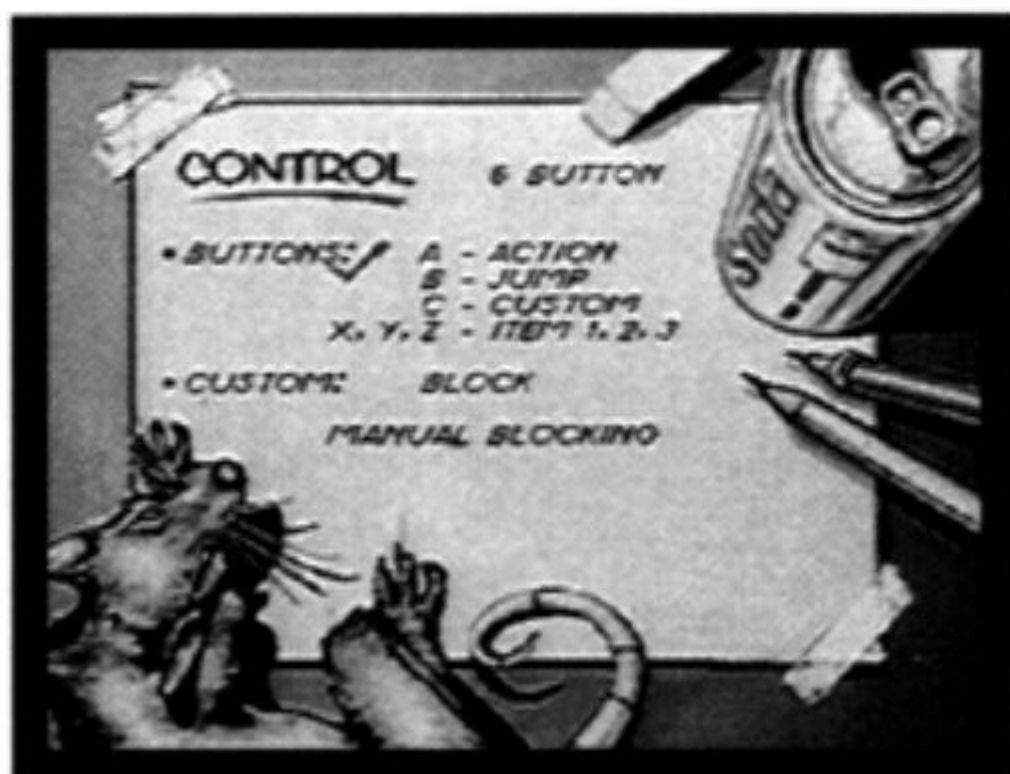

NOTE —

BLOCK is the default Custom Move. If you assign a different Custom Move, Sketch will block automatically during fights.

JUKEBOX

- Listen to your favorite Comix Zone tunes.

EXIT

- Return to the Title screen.



PLAY CONTROLS

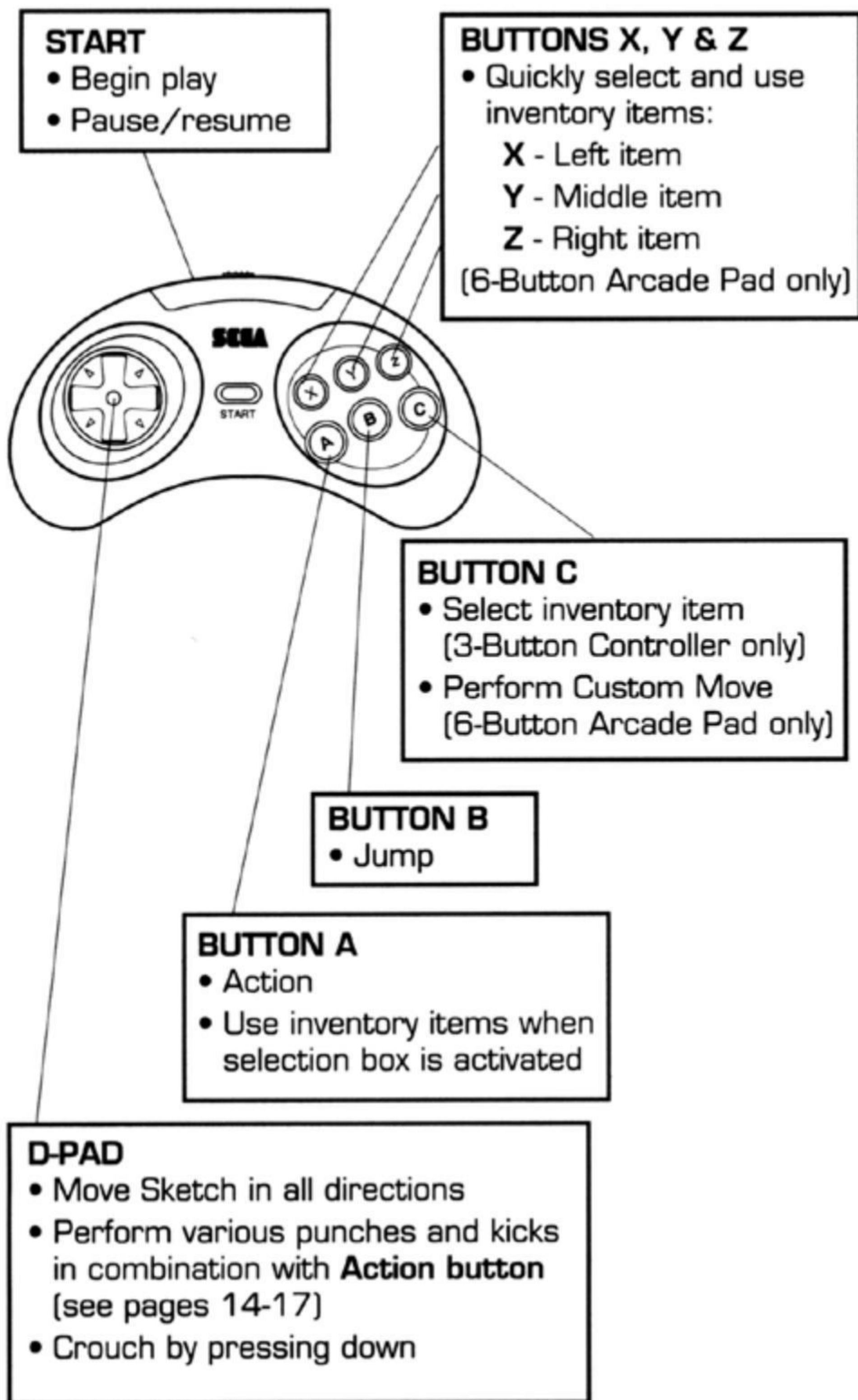

BASIC MOVES

- Pick up objects by moving Sketch over them and pressing the **D-Pad** down.
- Push objects by standing next to them and pressing the **D-Pad** left or right.
- Jump and hang by pressing the **Jump button** under a pipe, ledge or other hand-hold.
- Move while hanging by pressing the **D-Pad** left or right.
- Kick while hanging by pressing the **Action button + D-Pad**.
- Pull levers by getting within arm's reach and pressing the **Action button**.
- When using a 3-button controller, press the **Custom button** to highlight inventory items, and press the **Action button** to use them.



NOTE —

Sketch's moves are the same with either a 6-Button Arcade Pad or 3-button controller.



FIGHTING MOVES

Here are the real Mutant-mashing attacks that you (and Sketch!) must master to escape the Comix Zone. Remember . . .

- **Action button** attacks change with the position of the **D-Pad**.
- Press the **D-Pad** either **before** or **at the same time as** the **Action button** to perform many of the moves.
- Tap the **Action button** rapidly for one of the three **Serial Attacks**. Enemies may attempt to block, but as soon as you get in three valid hits, you'll finish them off with a special move!
- You can fool most enemies with **Combination Moves**. Enemies cannot block rapidly alternating attacks! So, hit 'em once, then quickly pound 'em again with a different move.
- Experiment to find deadly special moves.

NOTES —

- All button combinations show attacks to the RIGHT. Reverse the **D-Pad** direction for attacks to the LEFT.
- Button combinations use the default **Button A** as the **Action button**. You can reconfigure the button controls on the Options screen. (See page 11.)
- Serial and Combination Attacks only work during battles with humanoid enemies.

Serial Double Punch



Good ol' fashioned straight punches are the best shots of any street fighter, in the comics or out. Fire off a sequence of these, manage three valid hits and Sketch finishes up with a scissor kick!

Serial High Kick Tornado

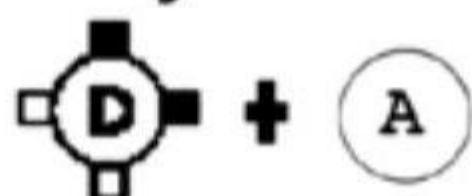

A jaw-shattering single kick turns into a tornado of spin kicks with multiple button taps. Slam the enemy three times for a whirlwind finish!

Serial Low Kick

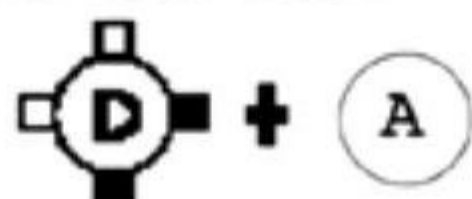

This low attack finishes with a furious wheel kick with rapid button taps.

Uppercut

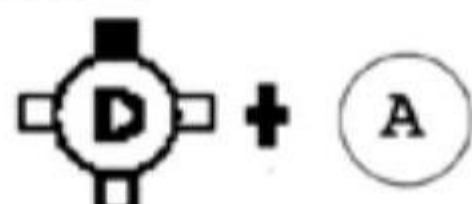

Send 'em from the floor to the moon with this shot!



Floor Sweep

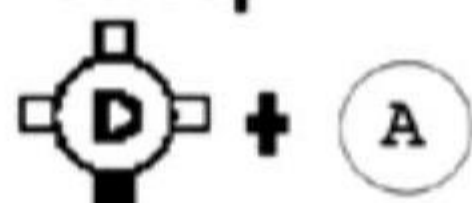

Hit 'em as low as you can go!



Back Kick/Turn Around



Tremendously satisfying when you're sandwiched between two enemies. Or, jump over an enemy and kick him **before** he turns around!

Whirlwind Jump Kick



Get maximum air for a nasty whirlwind kick.

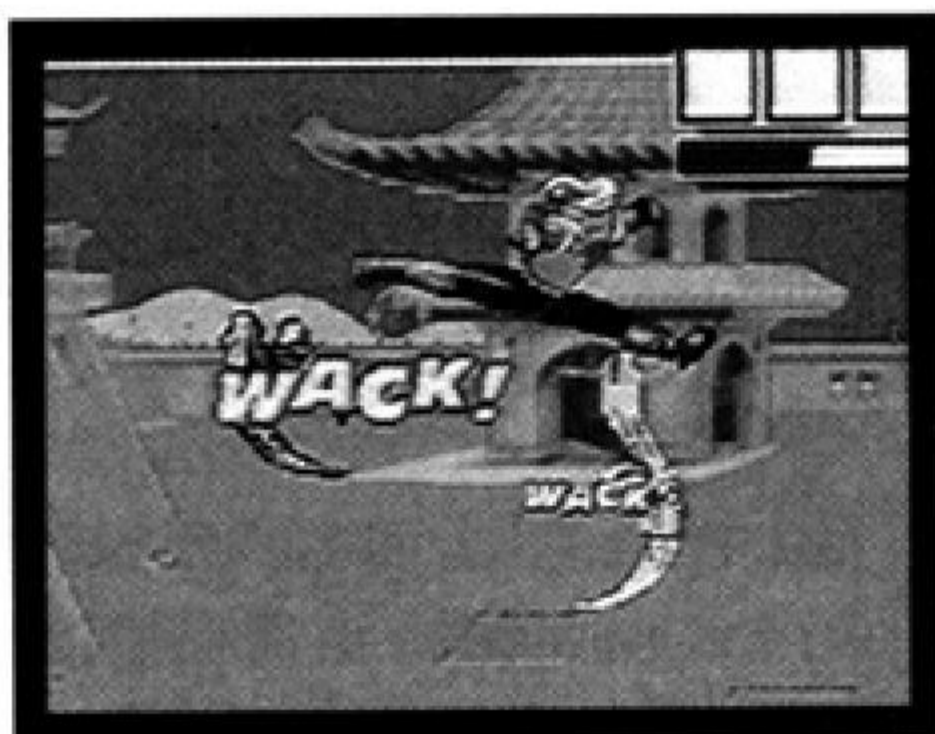



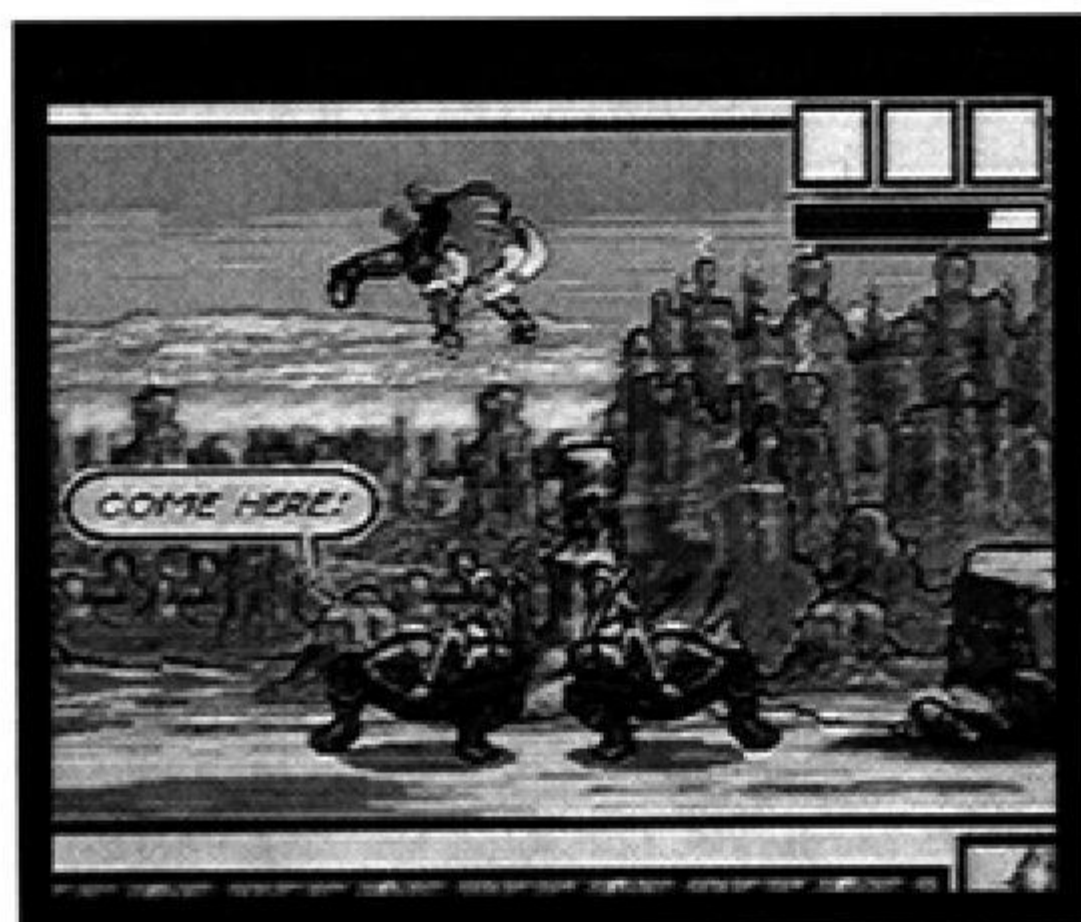
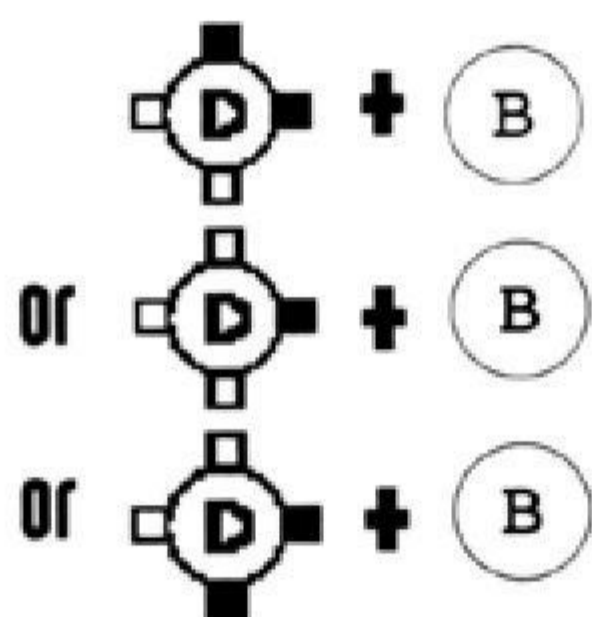



Somersault Leap Forward

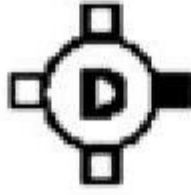

Great for attacks, retreats and getting high!

Flying Dragon Kick

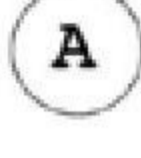
 +  then 
or  +  then 
or  +  then 

Never under-estimate this kung-fu classic!

Grab-A-Mutant

Get in their face close . . .

 hold, then  again
. . . to scissor kick 'em, or . . .

 hold, then  + 
. . . to toss 'em.

Roll

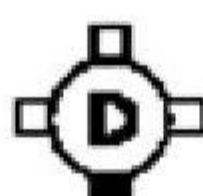
 then 

An excellent way to dodge some attacks.



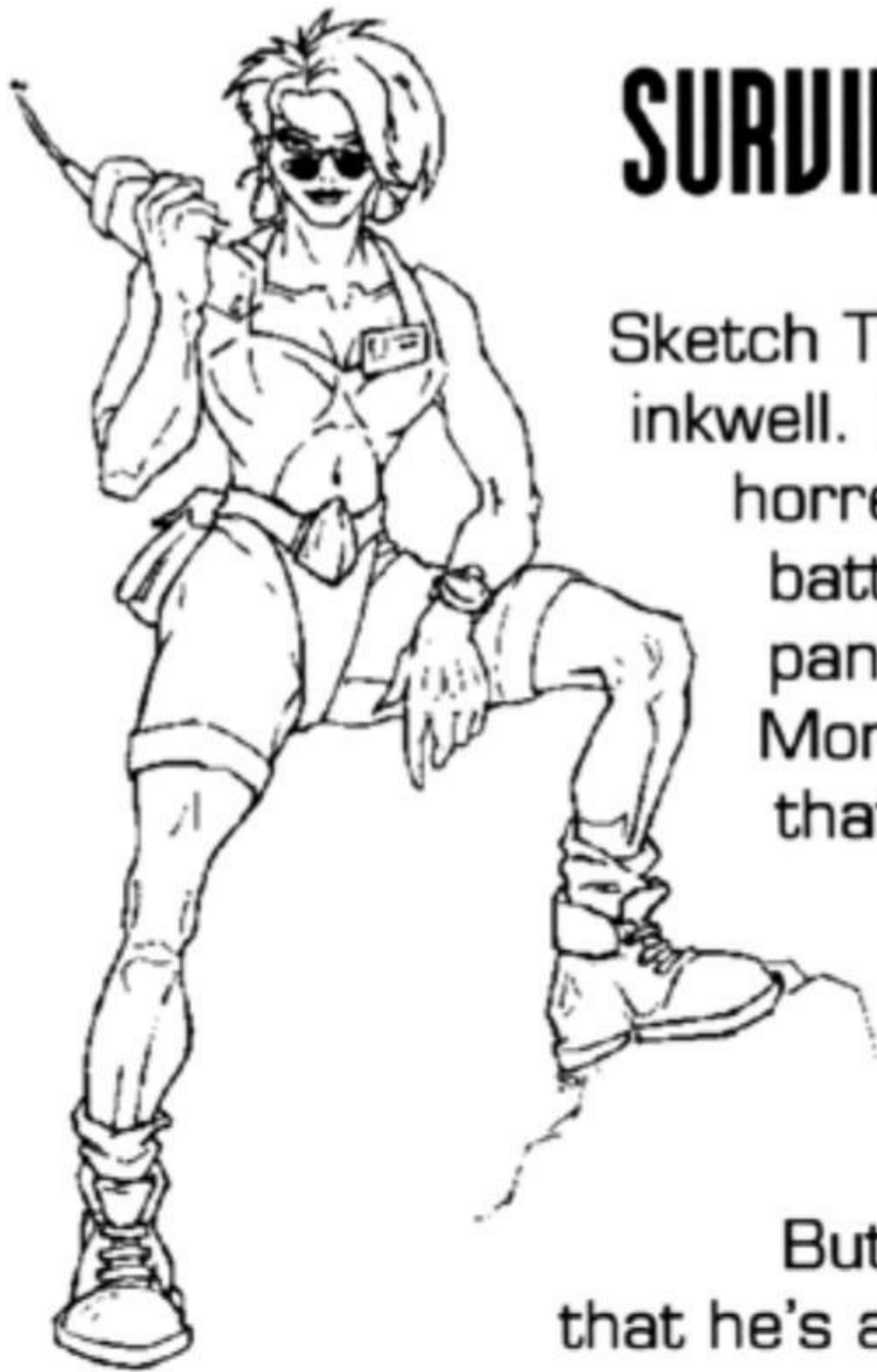

SURVIVE COMIX ZONE!

Sketch Turner is in it up to his inkwell. Mortus is drawing horrendous creatures to battle Sketch in every panel of the strip. If Mortus destroys Sketch, that megalomaniac Mutant will become real . . . and Earth will be doomed to his rule!

But there is hope. Now that he's a comic book superhero, Sketch can kick some serious butt. Instantly, Sketch can fight like a one-man mercenary platoon!

PLUS! Sketch's pet rat Roadkill has morphed into a killer attack rodent. Sketch can sic him on the Mortus Mutants and know there will always be shocking developments.

AND! Alissa Cyan is backing Sketch with constant situation reports and battle advice. Does Mortus have plans for her, too?

Comix Zone has three Episodes. Each Episode is two comic-book pages long, packed with many panels of action. Each panel contains a peril, puzzle or obstacle that Sketch must master.

Can Sketch make it to the end of the book? Can he defeat Mortus and come back to the real world? The future is in your hands . . .

THE SCREEN

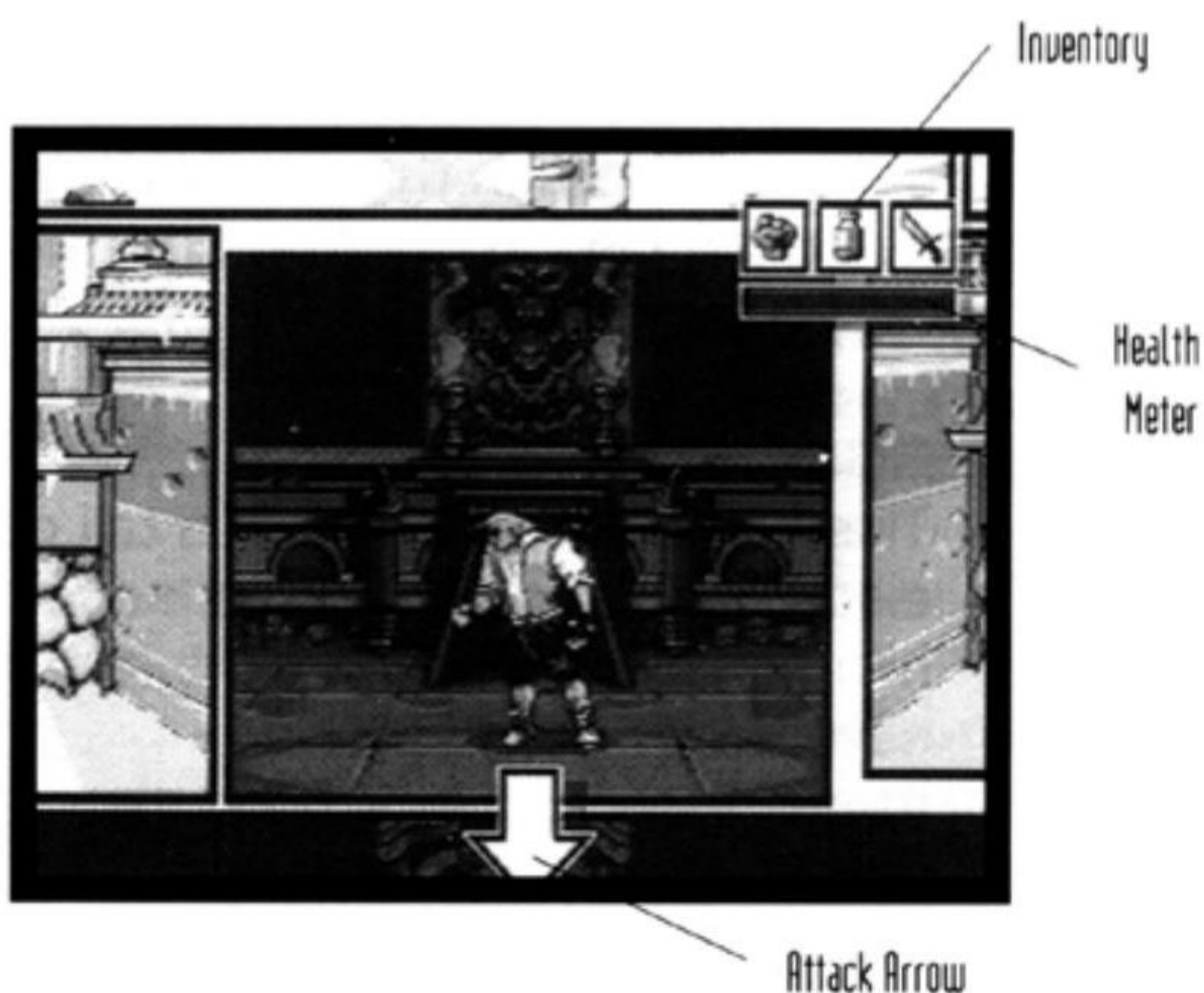

HEALTH METER

This shows how much life Sketch has left. When the green bar runs out and a red alert appears, better have some Ice Tea ready.

HEALTH TIP —

Sketch depletes some of his health when performing special moves or hitting solid objects. So think smart. Don't waste energy when you can use your brain (or explosives!) to do the dirty work.

INVENTORY

Holds your power-up items. You can carry up to three inventory items at a time. (See page 20.)

ATTACK ARROW

A flashing arrow prompts Sketch to the next panel as soon as he's conquered the one he's in. Sometimes Sketch will have a choice of two routes. Take your chances!



INVENTORY ITEMS

Look for these life-saving items in every panel during Sketch's travels through the Comix Zone. Pick up as many as you can! To pick up an item, stand over it and press the **D-Pad** down.



ROADKILL

This is Sketch's pet rat. His tail got electrified during the warp, so let him use his new-found ability to your advantage . . . ZZZAP 'em! Don't forget, Roadkill has a good sense of smell — he can often sniff out hidden goods!



ICE TEA

A swallow of this refreshing drink will partially restore a depleted health meter. Save some for bad times!



SUPERHERO

This fist turns Sketch into a page-ripping superhero!!! Use it when the going gets tough.



KNIFE

A good old-fashioned long-range weapon. Great for turning switches and setting off explosives at a distance.



GRENADE

Some hard-to-reach bozo giving you a hard time? Throw him one of these and watch the fireworks!



BOMB

Danger — high explosives! A dynamite weapon that blasts whatever's nearby . . . including Sketch!



SURPRISE

Pick up the "?" and you could get any of the other power-ups, or . . . KABOOM! So, don't touch these if your health is low!



MUTANT HIT LIST

Behold your enemies! They sting, bite, shock and hit like a freight train. When you destroy them, Mortus draws more.

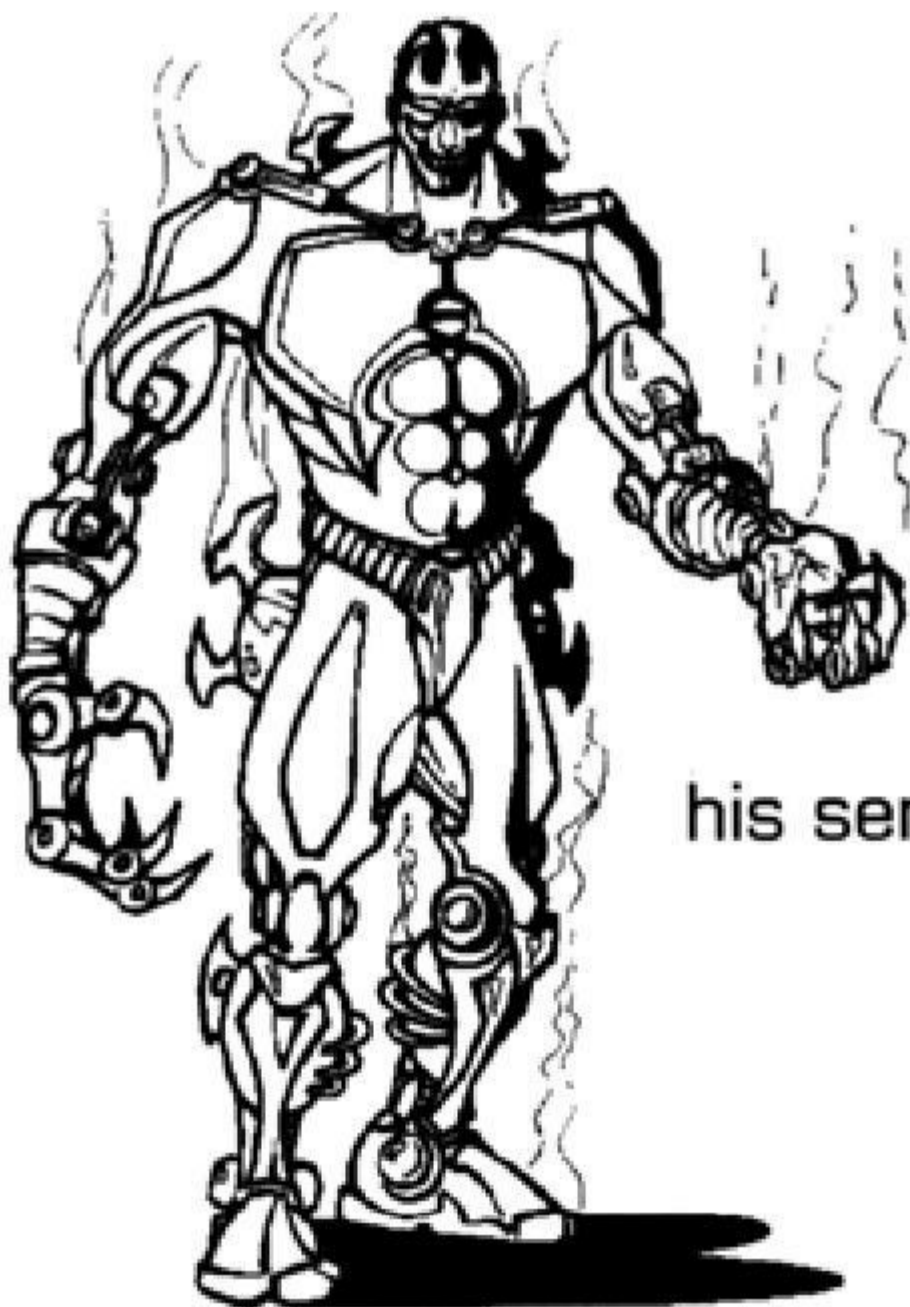

Gravis the Bully

This android brute only appears to be dumb and slow. Watch out for his sentinel attacks . . .

Strigil the Assassin

These shadow assassins have a deadly way with crowbars . . .



Spawn Mutant

The Mutant's true form? Don't try to grab him or you'll find out!

Mongoria

These super quick terrors may be the worst threat, short of Mortus himself. They hate each other . . . so play that to your advantage.

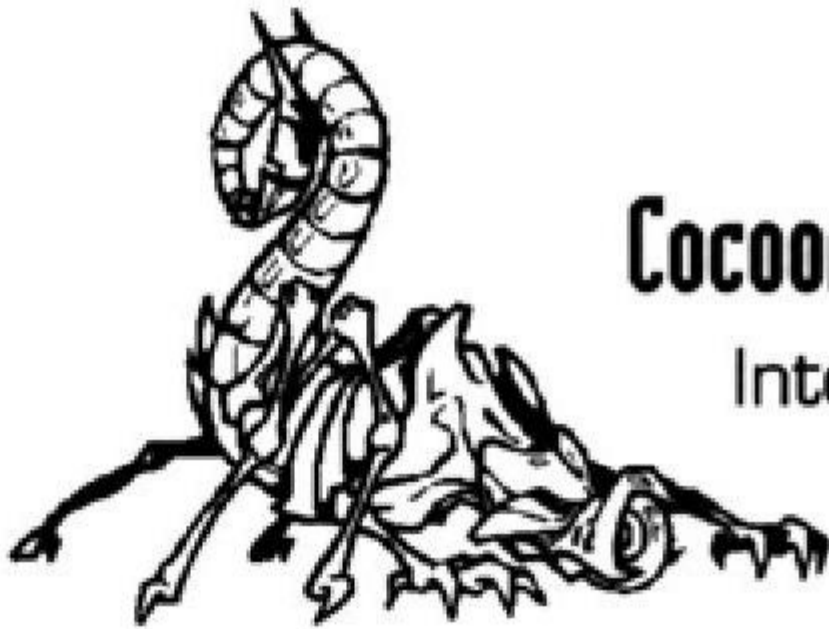
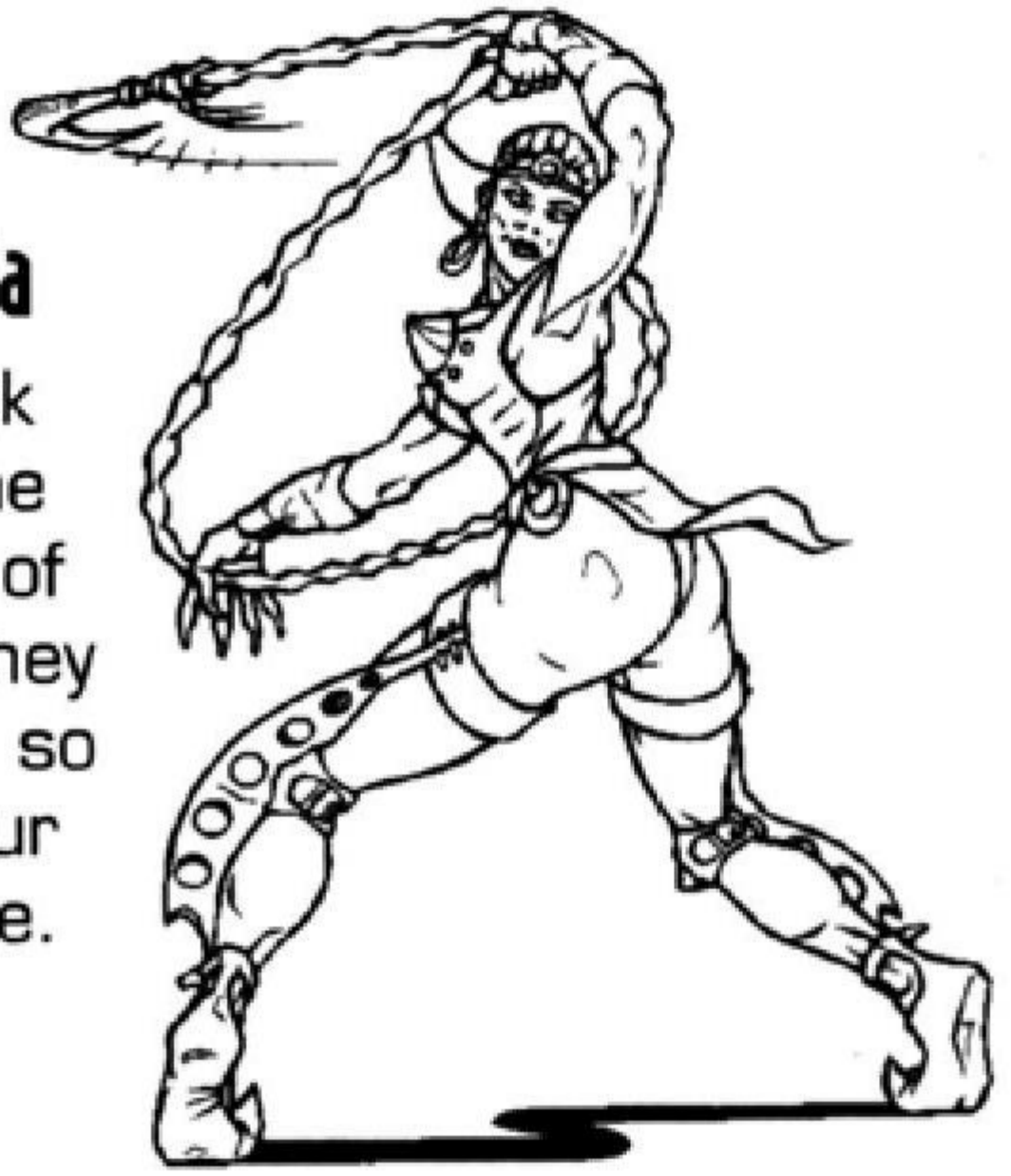

Cocoon Crawler

Intended as a food source for newborn Mutants, these creatures will sting, no matter who you are!



Styx the Monk

Gives an entertaining gymnastics show while tearing you apart from atop his hydraulic staff. Your jumping skill will prove useful here!



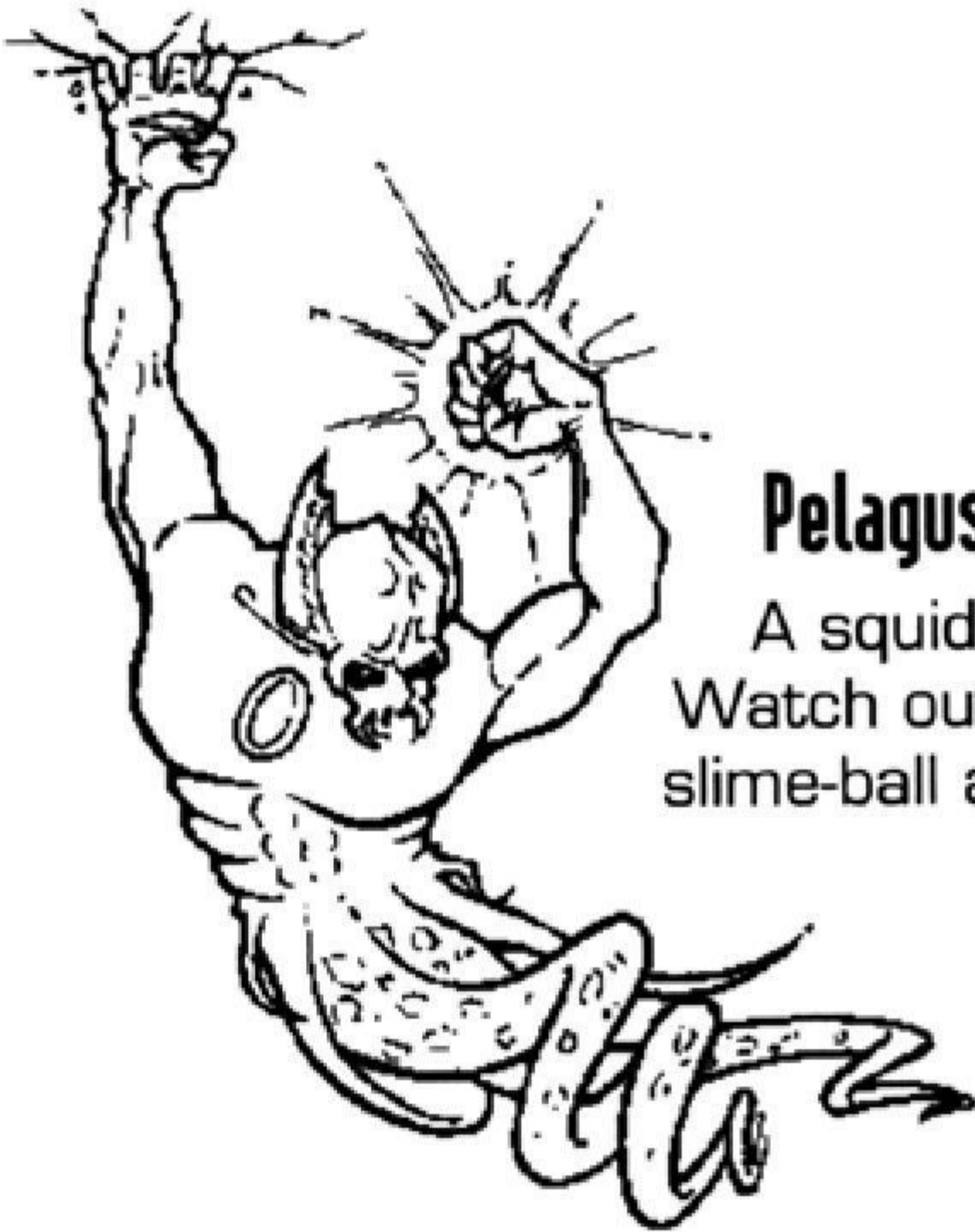

Pelagus

A squid? A man? The devil?
Watch out for his bouncing
slime-ball and spring attacks!

Flying Creature

Not very tough — a few
jump kicks or uppercuts will
do. But beware —these
creatures are part of a
larger being . . .



EPISODES

Night of the Living Mutants

The sewers are alive with Mutants, traps and dead ends. They're guarding the place with their lives . . . Why?? Learn the ropes.

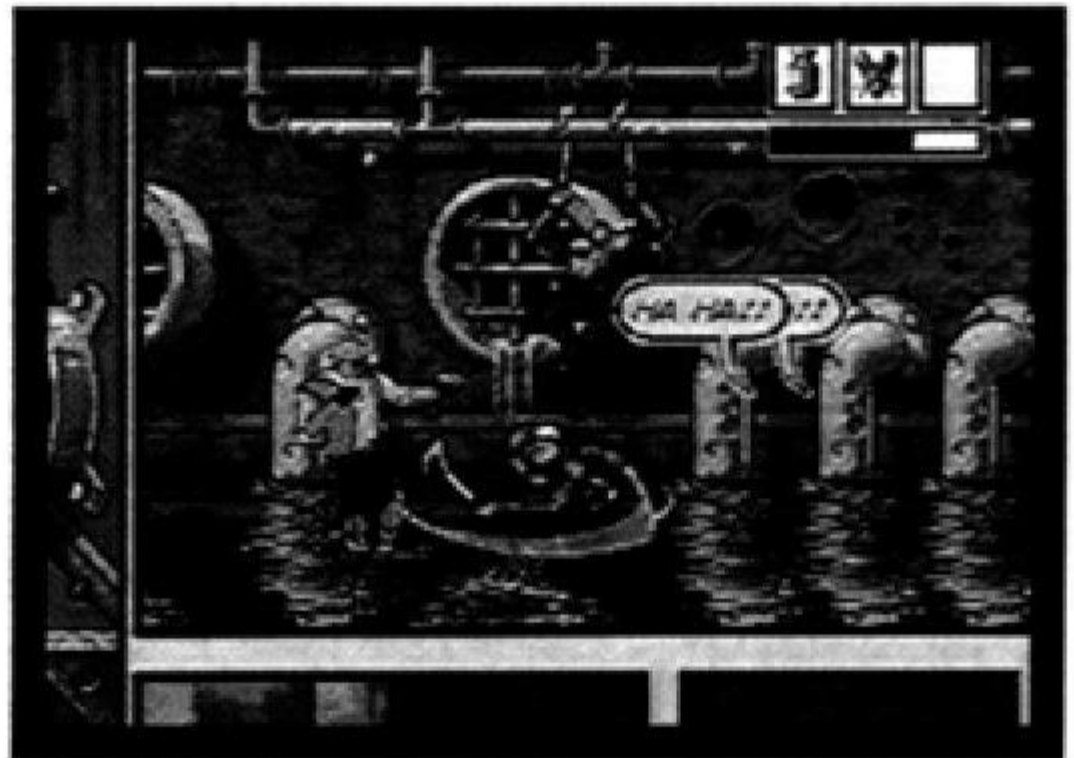

Welcome to the Temple – Not!

Fight for your life, while a screaming crowd calls for your head. Is this a training ground for the syndicate?

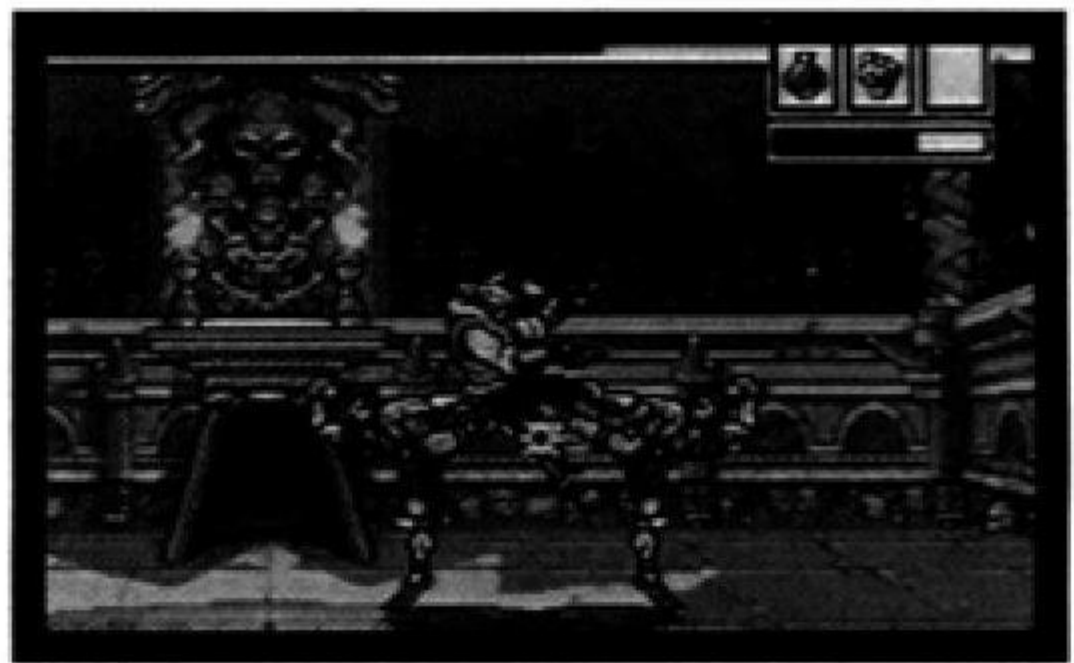

Curse of the Dead Ships

This wreckage graveyard holds a deadly secret. Does the story end here???



CREDITS

CONCEPT, DESIGN & ART DIRECTION

Peter Morawiec

TECHNICAL DIRECTOR & PROGRAMMER

Adrian Stephens

MUSIC & SOUND EFFECTS

Howard Drossin

ART

**Aoki Kunitake,
Fei Cheng,
Craig Stitt**

ANIMATION

**Chris Senn,
Tom Tobey,
Dean Ruggles,
Bob Steele, Ross Harris**

CONCEPTUAL ART

Tony DeZuniga, Alex Niño

AI SCRIPTING

**Adrian Stephens,
Peter Morawiec,
Robert Morgan,
Dean Lester**

CHARACTER VOICES

**Howard Drossin – Sketch, Mortus, Strigil, Kung-Fung Boss
Deborah Costa – General Alissa Cyan
Peter Morawiec – Gravis
Fei Cheng – Styx the Monk
Sue Ortlip – Mongoria**

EXECUTIVE PRODUCER

Dean Lester

ASSOCIATE PRODUCER

Mike Wallis

PRODUCT MANAGERS

John Gillin, John Garner

MARKETING SPECIALIST

Clint Dyer

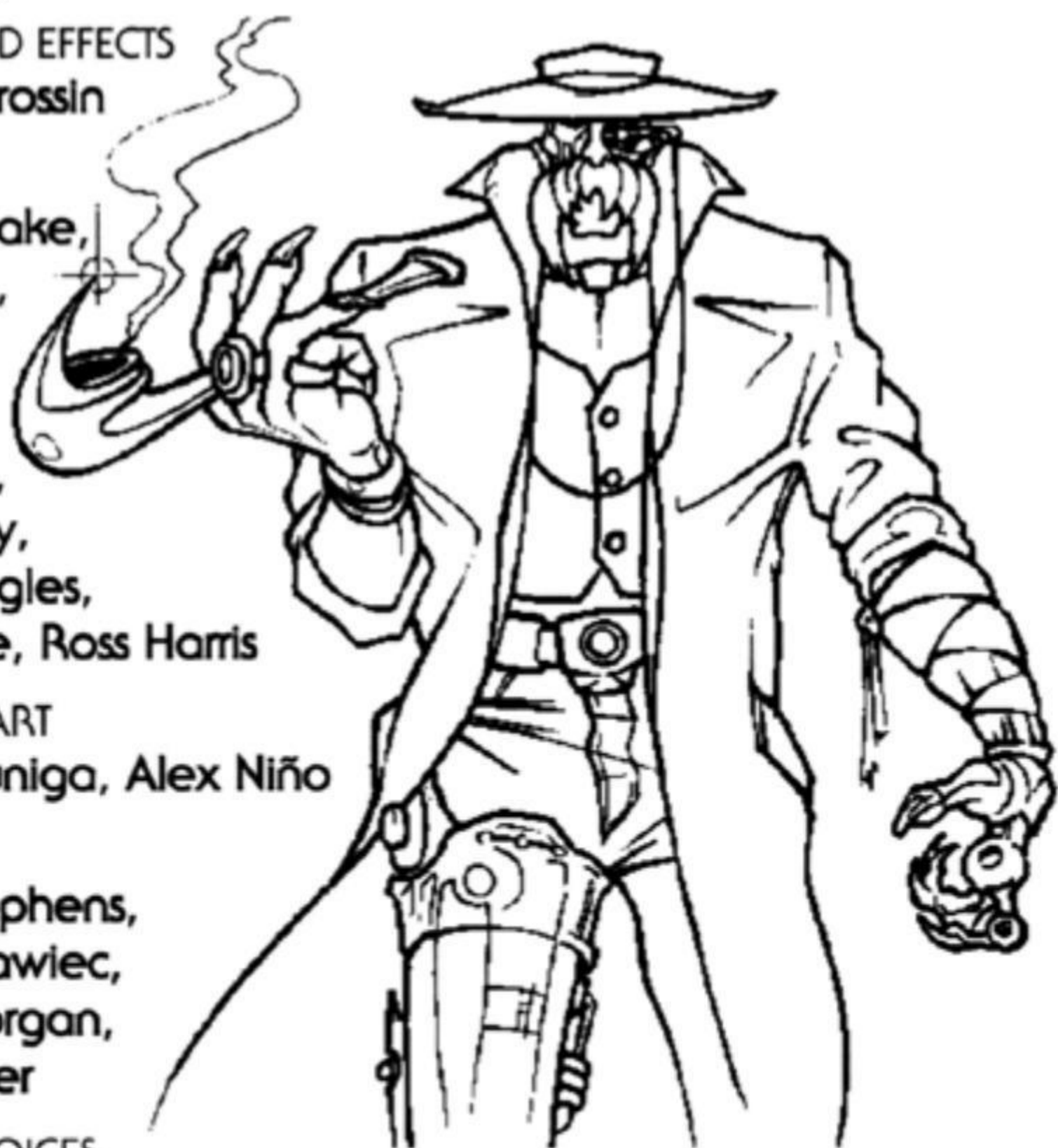

LEAD TESTER

Kimberly Rogers

TESTERS

Sean Doidge, Fernando Valderrama,
Stephen Wong, David Wood,
Chris Colon, Mark Dawson,
Mike Williams, Arnold Feener,
Aron Drayer, Abe Navarro,
Roger Sommerville, Michael McCollum,
Rob Prideaux, Joel Breton,
Tony Lynch, Jeff Junio,
Janine Cook, Rey Alferez

MANUAL

Neil & Carol Ann Hanshaw
Peter Morawiec

MANUAL COMIC BOOK

Original Story by
Peter Morawiec

Written by
Steve Behling
& Michael Stewart
at Marvel Comics

Penciled, inked
& lettered by
Tony DeZuniga

SOA LIAISONS

Emi Kawamura,
Jill Alexander,
Osamu Shibamiya

SOE LIAISONS

Lia Ithel, Cara McMullan

SOJ LIAISON

Masanobu Tsukamoto

SPECIAL THANKS

Shinobu Toyoda,
Roger Hector,
Sue Ortlip, Sheri Hockaday, Deborah Costa,
Paul Sears, Terry Tang, John Duggan,
Stieg Hedlund, Tim Gedemer
and "The House" for the best lamb in town



WARNINGS

Read Before Using Your Sega Video Game System

EPILEPSY WARNING

A very small percentage of individuals may experience epileptic seizures when exposed to certain light patterns or flashing lights. Exposure to certain patterns or backgrounds on a television screen or while playing video games may induce an epileptic seizure in these individuals. Certain conditions may induce undetected epileptic symptoms even in persons who have no history of prior seizures or epilepsy. If you, or anyone in your family, has an epileptic condition, consult your physician prior to playing. **If you experience any of the following symptoms while playing a video game — dizziness, altered vision, eye or muscle twitches, loss of awareness, disorientation, any involuntary movement or convulsions — IMMEDIATELY discontinue use and consult your physician before resuming play.**

WARNING TO OWNERS OF PROJECTION TVS

Still pictures or images may cause permanent picture tube damage or mark the phosphor of the CRT. Avoid repeated or extended use of video games on large-screen projection televisions.

HANDLING YOUR SEGA CARTRIDGE

- The Sega Genesis cartridge is intended for use exclusively on the Sega Genesis System.
- Do not bend it, crush it or submerge it in liquids.
- Do not leave it in direct sunlight or near a radiator or other source of heat.
- Be sure to take an occasional break during extended play, to rest yourself and the Sega cartridge.

