

『Maple Bus 1.0』

Function Type Specifications

FT₅ : AR-Gun Function

Revision 0.75

Created by

Sega Enterprises

No. 2 Development Group, CS Development and Production Headquarters



Revision :

3/5-'98	0.50	Preliminary specifications
4/30-'98	0.60	Renamed AR-Gun commands: Start Adjustment to Start Initialize, End Adjustment to End Initialize, Transmit Adjustment Data to Transmit Initialize Data
5/15-'98	0.70	Added "5. Status Commands" on description of status commands.
5/29-'98	0.75	Deleted table 6-1 Command List (Preliminary) Modified section "6. Supported Commands"

Contents

1	AR-Gun Functional Requirements.....	1
1-1	Definition of the AR-Gun Functions.....	1
1-2	Functional Prerequisites.....	1
1-3	Description of the Composition of Elements.....	2
2	Operation of the AR-Gun Function.....	5
2.1	Device Operation.....	5
2.2	Operation as an AR-Gun.....	6
3	Device ID.....	7
3.1	Composition of the Device ID.....	7
3.2	Function Type.....	8
3.3	Function definition block.....	8
4	Data Format.....	9
4.1	Read Format.....	9
5	Status Commands.....	10
6	Support Commands.....	12
6.1	Control Commands.....	12
6.2	Special AR-Gun Command.....	18
6.3	Error Commands.....	21
7	AR-Gun Function Information.....	23
7-1	Types of Device Status.....	23
7-2	Fixed Device Status.....	23
7-3	Free Device Status.....	24
8	Afterword.....	25

1 AR-Gun Functional Requirements

1-1 Definition of the AR-Gun Functions

The AR-Gun Function takes the image data of the frame lines, displayed on the monitor using internal picture elements, and detects the AR-Gun's target coordinates. The AR-Gun Function must fulfill the following requirements.

- ① It must have built-in picture elements and be able to detect analog coordinate values.
There are no restrictions on the external appearance.
- ② It must conform to the [Maple Bus 1.0] Standard Specification.

1-2 Functional Prerequisites

The AR-Gun Function shall provide the following elements.

- . Digital direction keys: Ra,La,Da,Ua
- . Digital buttons: TR,Reload,C,Start
- . Status commands: ST₇ ~ ST₀
- . Analog levers: A1,A2
- . Analog XY coordinates: A3,A4
- . Analog keys: A5,A6

The AR-Gun Function must absolutely provide the following elements.

- . Digital direction keys: Ra,La,Da,Ua
- . Digital buttons: TR,Reload,C,Start
- . Status commands: ST₇ ~ ST₀
- . Analog XY coordinates: A3,A4

If these elements are not present, then it cannot be called AR-Gun.

1-3 Description of the Composition of Elements

This section describes the various elements of the AR-Gun.

① Digital direction keys : Ra,La,Da,Ua

These are digital keys (buttons) with the two values Press/Release (=ON/OFF). The pairs Ra and La, Da and Ua correspond to these states. The key (button) is placed on the same plane as the right-angle formed by the intersection of the Ra and La straight line and the line connecting Da and Ua. Ra indicates the right side and right direction, La the left side and left direction, Da the lower side and the down direction and this side, and Ua shows the upper side, the up direction and the opposite direction.

Press has the value of "0" and Release is "1". It is prohibited to generate ON data in three or more keys.

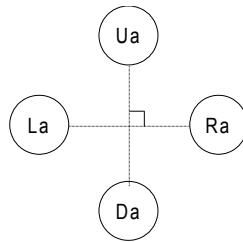

Fig. 1-1 Digital + key Button Arrangement

② Digital Buttons: TR,Reload,C,Start

These are digital buttons with the two values Press/Release (=ON/OFF). The button arrangement is optional. It must be able to detect multiple buttons being switched ON at the same time. The values are: Press = "0" and Release = "1".

③ Status Commands: ST₇ ~ ST₀

The commands indicate the recognition status of frame line images handled by picture elements. They are expressed using the 8 bits ST₇ ~ ST₀. See "5. Status Commands" on description of the recognition status of the frame line images.

④ Analog lever : A1,A2

It is an analog lever whose value changes linearly from its initial position. The value at its initial position is 00h, and it changes in increments of 01h from its minimum value of 00h to its maximum value of FFh. The direction of the key position which decreases the value is minus and the direction which increases the value is plus. The lever moves in these two directions, but it can only move in one direction from its initial position. When the load which moves the lever is removed, the lever automatically returns to its initial position. Generally, A1 indicates the R axis, and A2 the L axis. The R axis is manipulated with the right hand while the L axis is controlled with the left hand. They are used in 1 axis units.

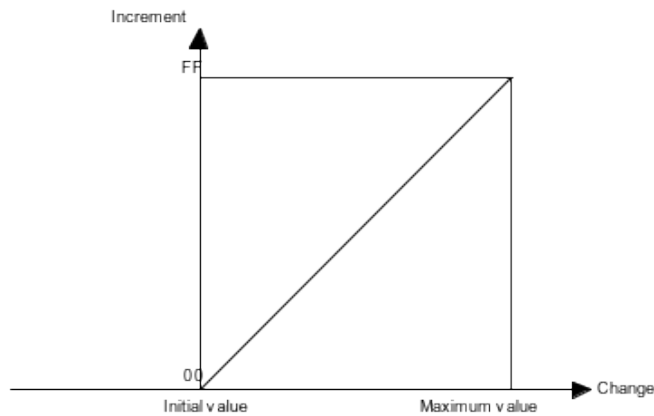

Fig. 1-2 Data Range of the Analog Lever

⑤ Analog XY Coordinates: A3,A4

The picture elements recognize the frame lines displayed on the monitor and the point on the screen that the gun is pointing at are expressed in analog XY coordinates. The thick line in Fig. 1-10 indicates the frame line images output onto the monitor. The outer frame lines indicate the range of the image taken. Also, the X, Y coordinates of the center of the screen are both 80h, and the X, Y axes range from 00h ~ Ffh (+125₁₀ ~ 125₁₀).

However, 00h and FFh indicate that the screen range has been exceeded.

Generally, A3 is the X axis, A4 is the Y axis.

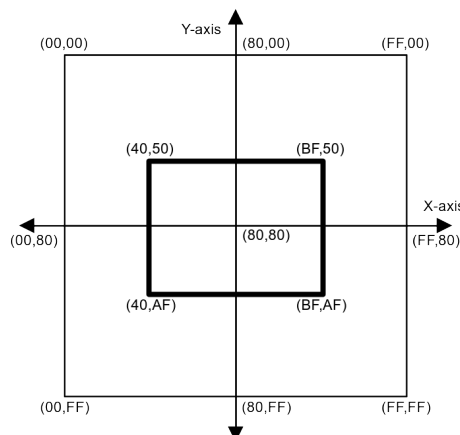

Fig. 1-3 AR-Gun coordinate system

⑤ Analog Key: A5,A6

This is an analog style key whose detected value changes linearly with the amount of change from the key's initial position. The value at the key's initial position is 80h, its minimum value is 00h and its maximum value is FFh, changing in units of 01h. The key can be moved in two directions. The direction which reduces the value is minus and the direction which increases its value is plus. When constraints on the key's movement are removed, it is automatically centered and returns to its initial position.

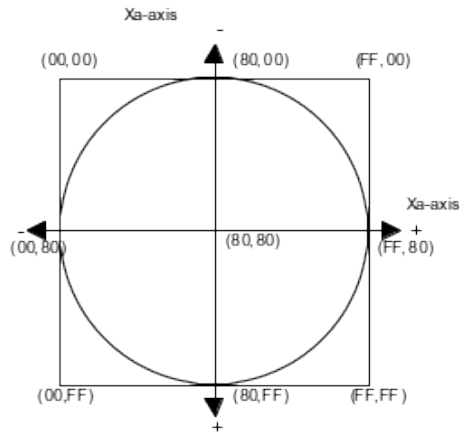

Fig. 1-4 Data Range of the Analog Key

2 Operation of the AR-Gun Function

This section describes the operation of the AR-Gun Function as a device and as the AR-Gun. The AR-Gun is manufactured in accordance with these function operations.

2.1 Device Operation

① Initialization

Makes initial settings of registers used and RAM, etc.

Resets the MIE, clears each flag and the TRBF.

Sets the MIE to receive enabled status.

Disconnects all LM-Buses and does not allow data to flow to the expansion devices.

The LM-Bus ID0 and ID1 are reversed from the setting values of the Bus No.

② LM-Bus Control

The LM-Bus is released until a [Device Request] is received.

When the first [Device Request] is received after initialization, the LM-Bus ID0, ID1 are reversed and returned to the setting values. A reset request is made to the expansion device at the same time. If a "1" is detected on each LM-Bus' ID2, that means the expansion device is connected, so that LM-Bus is connected to the Maple-Bus.

The status of the connected LM-Bus is read and reflected in the AP, which is the transfer source of the [Device Status] reply to the [Device Request].

If a "0" is detected on ID2 of each LM-Bus, the expansion device is considered to be disconnected and that LM-Bus is disconnected from the Maple-Bus. This ID2 check is conducted every time a command is received from the host.

③ Down Stream Time Out

The device is always detecting the Maple-Bus Down Stream Time Out (except during [Device Kill]).

When a Time Out occurs, it starts the following processes.

Table 2-1 Time Out Processing Sequence

Processing Order	Device	Expansion Device
1	Resets.	Normal operation
2	ID0, ID1 may be unspecified during reset. (Period is within 300 us (preliminary))	Normal operation ID0, ID1 are not reversed so it is not reset.
3	Reversed from the ID0, ID1 before the reset (Initialization)	ID0, ID1 are reversed, so it resets (LM-Bus reset)
4	Waits for a [Device Request].	Resets (Initialization)
5	Normal operation	Waits for a [Device Request]
6	Normal operation	Normal operation

④ Up Stream Time Out

There is a possibility that during transmission to the host (Up Stream) an error may occur on the MIE or Maple-Bus and it may not be able to get out of the transmission mode. In this case, the host detects a Time Out and performs a hard reset. However, because the device is still in transmission mode, it cannot receive the reset pattern. Therefore, it calculates the estimated time based on the device's transmission data size and if transmission continues for longer than that amount of time it will reset the MIE (Time Out processing).

2.2 Operation as an AR-Gun

① Key Scan

There is a constant need for the digital key (buttons) and analog key data (key data) to be updated. In addition, replies must always be made to requests for data from the host. Therefore, the key data is continually updated and sent in response to requests from the host. So there is no preferential order in key scanning; all of the keys (buttons) are scanned at the same time.

② Creation of Coordinate Data

The coordinate data of the AR-Gun's target position is calculated using the frame line images displayed on the monitor via the AR-Gun's picture elements. The data are 8 bit, X, Y coordinates.

③ Creation of Status Commands

Status commands are created in order to show the recognition status of the screen's frame lines when they are recognized by the picture elements. The data must be 8 bit, ST₇ ~ ST₀.

④ Optimization conditions

- a) No more than two of the + keys (buttons) can be ON at the same time (key data is not created).
- b) The + key's U and D, R and L cannot be turned ON at the same time (key data is not created).
- c) Multiple digital buttons can be detected as being ON at the same time.
- d) When two or more keys (buttons) are pressed at the same time, the keys (buttons) which are not being pressed will not turn ON (key data is not created).

3 Device ID

This section defines the Device ID based on the Maple Bus specifications. The Device ID consists of the function type, 1st function definition block, the 2nd function definition block, and the 3rd function definition block.

3.1 Composition of the Device ID

The device ID is composed of 16 bytes (128 bits). Table 3-1 shows the composition.

Table 3-1 Composition of the Device ID

bit	7	6	5	4	3	2	1	0
1st Data	FT ₃₁	FT ₃₀	FT ₂₉	FT ₂₈	FT ₂₇	FT ₂₆	FT ₂₅	FT ₂₄
2nd Data	FT ₂₃	FT ₂₂	FT ₂₁	FT ₂₀	FT ₁₉	FT ₁₈	FT ₁₇	FT ₁₆
3rd Data	FT ₁₅	FT ₁₄	FT ₁₃	FT ₁₂	FT ₁₁	FT ₁₀	FT ₉	FT ₈
4th Data	FT ₇	FT ₆	FT ₅	FT ₄	FT ₃	FT ₂	FT ₁	FT ₀
5th Data	FD1 ₃₁	FD1 ₃₀	FD1 ₂₉	FD1 ₂₈	FD1 ₂₇	FD1 ₂₆	FD1 ₂₅	FD1 ₂₄
6th Data	FD1 ₂₃	FD1 ₂₂	FD1 ₂₁	FD1 ₂₀	FD1 ₁₉	FD1 ₁₈	FD1 ₁₇	FD1 ₁₆
7th Data	FD1 ₁₅	FD1 ₁₄	FD1 ₁₃	FD1 ₁₂	FD1 ₁₁	FD1 ₁₀	FD1 ₉	FD1 ₈
8th Data	FD1 ₇	FD1 ₆	FD1 ₅	FD1 ₄	FD1 ₃	FD1 ₂	FD1 ₁	FD1 ₀
9th Data	FD2 ₃₁	FD2 ₃₀	FD2 ₂₉	FD2 ₂₈	FD2 ₂₇	FD2 ₂₆	FD2 ₂₅	FD2 ₂₄
10th Data	FD2 ₂₃	FD2 ₂₂	FD2 ₂₁	FD2 ₂₀	FD2 ₁₉	FD2 ₁₈	FD2 ₁₇	FD2 ₁₆
11th Data	FD2 ₁₅	FD2 ₁₄	FD2 ₁₃	FD2 ₁₂	FD2 ₁₁	FD2 ₁₀	FD2 ₉	FD2 ₈
12th Data	FD2 ₇	FD2 ₆	FD2 ₅	FD2 ₄	FD2 ₃	FD2 ₂	FD2 ₁	FD2 ₀
13th Data	FD3 ₃₁	FD3 ₃₀	FD3 ₂₉	FD3 ₂₈	FD3 ₂₇	FD3 ₂₆	FD3 ₂₅	FD3 ₂₄
14th Data	FD3 ₂₃	FD3 ₂₂	FD3 ₂₁	FD3 ₂₀	FD3 ₁₉	FD3 ₁₈	FD3 ₁₇	FD3 ₁₆
15th Data	FD3 ₁₅	FD3 ₁₄	FD3 ₁₃	FD3 ₁₂	FD3 ₁₁	FD3 ₁₀	FD3 ₉	FD3 ₈
16th Data	FD3 ₇	FD3 ₆	FD3 ₅	FD3 ₄	FD3 ₃	FD3 ₂	FD3 ₁	FD3 ₀

FT: Function type of the peripheral device

FD1: 1st function definition block

FD2: 2nd function definition block

FD3: 3rd function definition block

① FT₃₁ ~ FT₀: Function type

It defines the function type provided by the peripheral device.

There are a total of 32 types of functions which are defined.

② FD₃₁ ~ FD₀: Function definition block

It is the block which defines the individual elements making up the function.

(One peripheral device can have up to three different functions.)

3.2 Function Type

It is a description of the function type (FT) within the Device ID. The AR-Gun's function is FT₅="1".

Table 3-2 AR-Gun Function Type

bit	7	6	5	4	3	2	1	0
1st Data	FT ₃₁	FT ₃₀	FT ₂₉	FT ₂₈	FT ₂₇	FT ₂₆	FT ₂₅	FT ₂₄
2nd Data	FT ₂₃	FT ₂₂	FT ₂₁	FT ₂₀	FT ₁₉	FT ₁₈	FT ₁₇	FT ₁₆
3rd Data	FT ₁₅	FT ₁₄	FT ₁₃	FT ₁₂	FT ₁₁	FT ₁₀	FT ₉	FT ₈
4th Data	FT ₇	FT ₆	1	FT ₄	FT ₃	FT ₂	FT ₁	FT ₀

3.3 Function definition block

This is a description of the Function definition block (FD) within the Device ID. The AR-Gun definition block specifies the elements which make up the function that is used. The read format of the data format is divided and specified..

Table 3-3 AR-Gun Function definition block

bit	7	6	5	4	3	2	1	0
1st Data	0	0	0	0	0	0	0	0
2nd Data	0	0	RB ₂₁	RB ₂₀	RB ₁₉	RB ₁₈	RB ₁₇	RB ₁₆
3rd Data	RB ₁₅	RB ₁₄	RB ₁₃	RB ₁₂	RB ₁₁	RB ₁₀	RB ₉	RB ₈
4th Data	RB ₇	RB ₆	RB ₅	RB ₄	RB ₃	RB ₂	RB ₁	RB ₀

RB: Read format division block

"0" indicates a fixed 0.

The block division of the read format is shown in table 3-4. The read format is explained in the next chapter. In accordance with table 3-3, the setting bit of blocks which are used is set to "1" and those which are not used are set to "0".

Table 3-4 Read Format Block Division

bit	7	6	5	4	3	2	1	0
1st Data	RB ₇	RB ₆	RB ₅	RB ₄	RB ₃	RB ₂	RB ₁	RB ₀
2nd Data	RB ₁₅	RB ₁₄	RB ₁₃	RB ₁₂	RB ₁₁	RB ₁₀	RB ₉	RB ₈
3rd Data	RB ₁₆							
4th Data	RB ₁₇							
5th Data	RB ₁₈							
6th Data	RB ₁₉							
7th Data	RB ₂₀							
8th Data	RB ₂₁							

4 Data Format

It describes the AR-Gun Function's data format. The table shows the host's memory image.

4.1 Read Format

The data format which is used when the AR-Gun Function's data is read is shown in table 4-1.

When the host transmits a [Get Condition], it is sent as [Data Transfer] data from the AR-Gun. The size of the data format is 8 bytes. The data used in this data format is defined in the function definition block.

Table 4-1 AR-Gun Data Format

bit	7	6	5	4	3	2	1	0
1st Data	Ra	La	Da	Ua	Start	TR	Reload	C
2nd Data	ST ₇	ST ₆	ST ₅	ST ₄	ST ₃	ST ₂	ST ₁	ST ₀
3rd Data	A1 ₇	A1 ₆	A1 ₅	A1 ₄	A1 ₃	A1 ₂	A1 ₁	A1 ₀
4th Data	A2 ₇	A2 ₆	A2 ₅	A2 ₄	A2 ₃	A2 ₂	A2 ₁	A2 ₀
5th Data	A3 ₇	A3 ₆	A3 ₅	A3 ₄	A3 ₃	A3 ₂	A3 ₁	A3 ₀
6th Data	A4 ₇	A4 ₆	A4 ₅	A4 ₄	A4 ₃	A4 ₂	A4 ₁	A4 ₀
7th Data	A5 ₇	A5 ₆	A5 ₅	A5 ₄	A5 ₃	A5 ₂	A5 ₁	A5 ₀
8th Data	A6 ₇	A6 ₆	A6 ₅	A6 ₄	A6 ₃	A6 ₂	A6 ₁	A6 ₀

1st Data: Digital button data.

2nd Data: The recognition status of the frame lines is written to the host

3rd Data: Analog axis 1 data.

4th Data: Analog axis 2 data.

5th Data: Analog axis 3 data. (X coordinates)

6th Data: Analog axis 4 data. (Y coordinates)

7th Data: Analog axis 5 data.

8th Data: Analog axis 6 data.

5 Status Commands

ST₇~ST₀ as in table 2-7 are commands from the artificial retina to the host. The application reads these commands and the host sends command in response to them. In their initial settings all the bits are taken as "0." ST₇ is a bit to indicate whether the coordinate data is valid or invalid. It has a value of "0" when the coordinate is invalid, or "1" when the coordinate is valid.

Table 5-1 Screen Mode Settings

ST ₇	Valid co-ordinate/ Invalid co-ordinate
0	Invalid co-ordinate
1	Valid co-ordinate

ST₆~ST₅ は are bits to indicated frame line slant and sided shooting, which can fall into the following types as shown in the figures. If the approximately horizontal frame line image could not be taken, then the accuracy in detecting the co-ordinate will decrease.

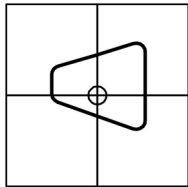

Fig. 5-1
Sided shooting

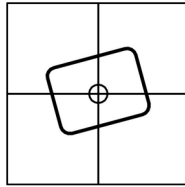

Fig. 5-2
Slanted left

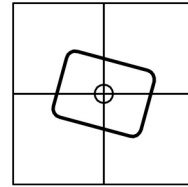

Fig. 5-3
Slanted right

Table 5-2 Frame Line Slant and Sided Shooting

ST ₆	ST ₅	Frame Line Slant
0	0	Sided shooting
0	1	Left slanted
1	0	Right slanted
1	1	Horizontal frame line

ST₄~ST₂ indicate the recognition status of frame lines, as shown in the following figures.

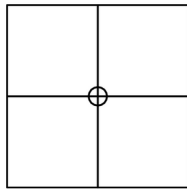

Fig. 5-4 Frame lines recognition not possible

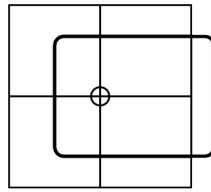

Fig. 5-5 One side recognition only

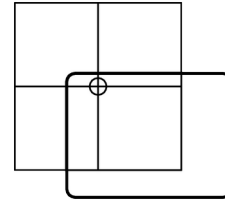

Fig. 5-6 One section recognition only

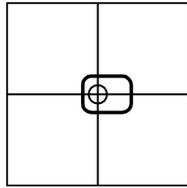

Fig. 5-7 Frame lines are small

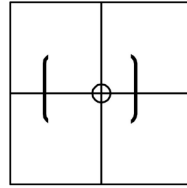

Fig. 5-8 Frame line height is 0

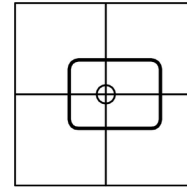

Fig. 5-9 Normal

If the frame line recognition status is not normal, then the co-ordinate detection accuracy will decrease.

Table 5-3 Frame Line Recognition

ST ₄	ST ₃	ST ₂	Frame line recognition status
0	0	0	Frame lines cannot be recognized
0	0	1	Only one side recognized
0	1	0	Only one section recognized
0	1	1	Frame lines are small
1	0	0	Frame line height is 0
1	0	1	Reserved
1	1	0	Reserved
1	1	1	Normal (Square shape recognized)

ST₁ indicates size of the frame line image taken. If the frame line image becomes smaller, then the co-ordinate detection accuracy will decrease.

Table 5-4 Frame Line Size

ST ₁	Frame line size
0	
1	Normal

ST₀ specifies the resolution. It indicates how the internal of the frame line image taken is divided, and this will affect the co-ordinate calculation. For a division of vertical 48 and horizontal 64:

Table 5-5 Resolution

ST ₀	Resolution
0	48 × 64
1	Reserved

6 Support Commands

These are commands specified in "[Maple Bus 1.0] Standard Specifications" that are also supported by the AR-Gun Function. If commands other than the supported commands are sent, AR-Gun Function will return an error code. The following describes the working of AR-Gun Function at each of the commands.

6.1 Control Commands

Device Request

Issuing authority: host

Command code: 01h

Data size: 00h

Data area: none

Expected return value: [Device Status]

Description: This command requests a [Device Status] from the transfer destination AP's AR-Gun Function. It is also used to do a connection check for each port. After function initialization, the AR-Gun will not respond to other commands until this command is sent. In addition, it disconnects the expansion device from the LM-Bus and halts the operation of the expansion device.

Order of operation:

- (1) Command received.
- (2) Connection of expansion device checked.
- (3) If it is connected, it connects the corresponding LM-Bus.
- (4) Based on that result, create the transfer AP source and reply to the host.

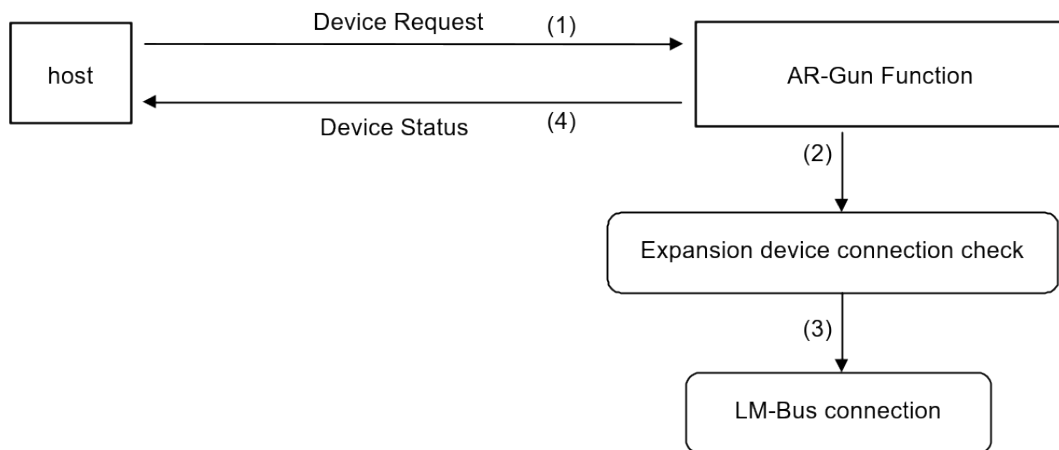

Fig. 6-1 Device Request

All Status Request

Issuing authority: host
 Command code: 02h
 Data size: 00h
 Data area: none
 Expected return value: [Device All Status]
 Description: Requests the status of all devices (Fixed Device Status and Free Device Status) from the transfer destination AP's AR-Gun Function devices.

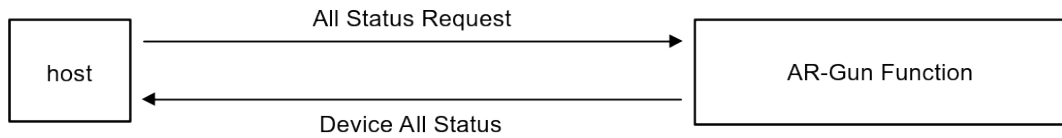

Fig. 6-2 All Status Request

Device Reset

Issuing authority: host
 Command code: 03h
 Data size: 00h
 Data area: none
 Expected return value: [Device Reply]
 Description: Initializes AR-Fun Function specified by the transfer destination AP.
 Order of operation: (1) Returns [Device Reply].
 (2) Performs initialization.

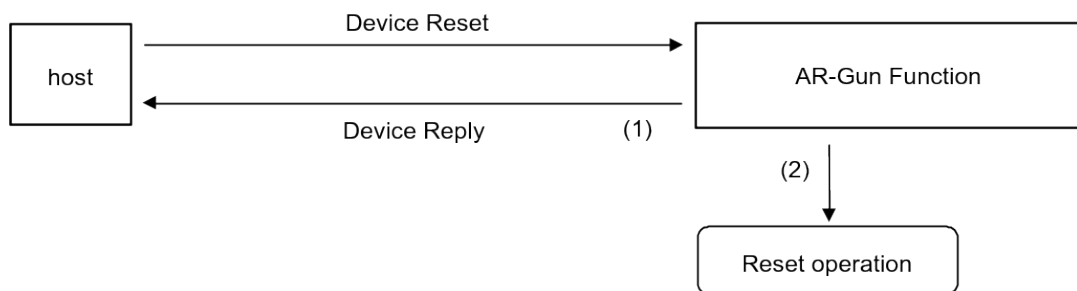

Fig. 6-3 Device Reset

Device Kill

Issuing authority: host
 Command code: 04h
 Data size: 00h
 Data area: none
 Expected return value: [Device Reply]
 Description: Does not permit operation of AR-Gun Function specified by the transfer destination AP. The function waits on standby power (minimum power consumption) and does not receive any commands. In order to resume operation, a hard reset must be performed or the power must be turned off and then restarted. When the AR-Gun receives a [Device Kill], the LM-Bus ID0, ID1 are reversed, the expansion device is reset and the LM-Bus is disconnected.

Order of operation:
 (1) Resets the LM-Bus and disconnects from the Maple-Bus.
 (2) Returns a [Device Reply].
 (3) Halts operation

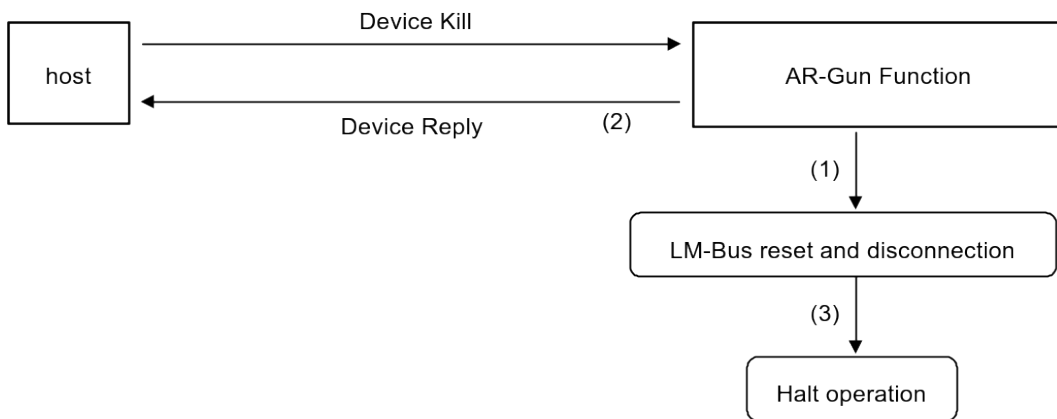

Fig. 6-4 Device Kill

Device Status

Issuing authority: AR-Gun Function
 Command code: 05h
 Data size: 1Ch(28)
 Data area: Device ID: 16Byte
 Region code: 1Byte
 Connection direction: 1Byte
 Product name: 30Byte
 License: 60Byte
 Standby current: 2Byte
 Maximum current: 2Byte
 Description: Returns Fixed Device Status data in response to a [Device Request] from the host,

Device All Status

Issuing authority: AR-Gun Function
Command code: 06h
Data size: 1Ch+(n/4)
Data area: Fixed Device Status: 112Byte
Device ID: 16Byte
Region code: 1Byte
Connection direction: 1Byte
Product name: 30Byte
License: 60Byte
Standby current: 2Byte
Maximum current: 2Byte
Free Device Status: n Byte

Device Reply

Issuing authority: AR-Gun Function
Command code: 07h
Data size: 00h
Data area: none
Description: Used for replying.

Data Transfer

Issuing authority: AR-Gun Function

Command code: 08h

Data size: 02h for replying to AR Control, or 03h for replying to Get Condition

Data area: Function type: 4Byte
Specify AR-Gun (00-00-00-20h) .

Read format: 8Byte (When replying to Get Condition)

AR setting data : 4byte (When replying to AR Control)

Expected return value: none

Description: Issued to return AR-Gun read format and AR setting data when [Get Condition] or [AR Control] is received from the host.

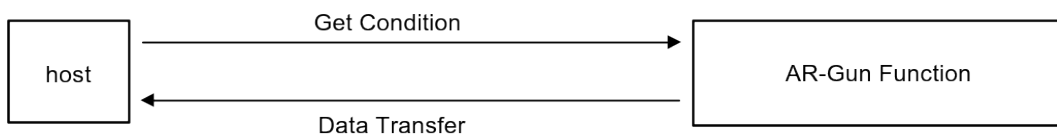

Fig. 6-5 Data Transfer

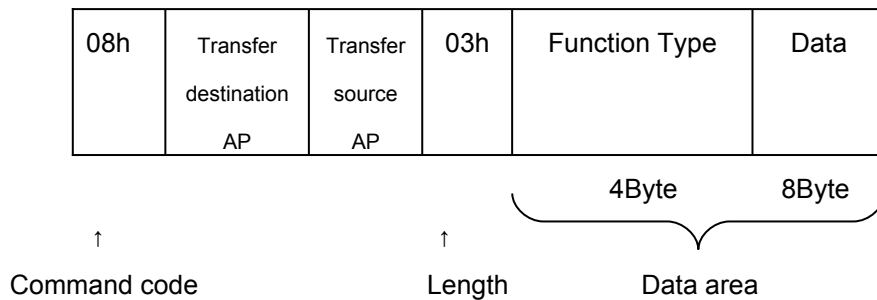

Fig. 6-6 Data Transfer Frame Composition During [Get Condition]

Data area: Function type: 4Byte
Read format data: 8Byte

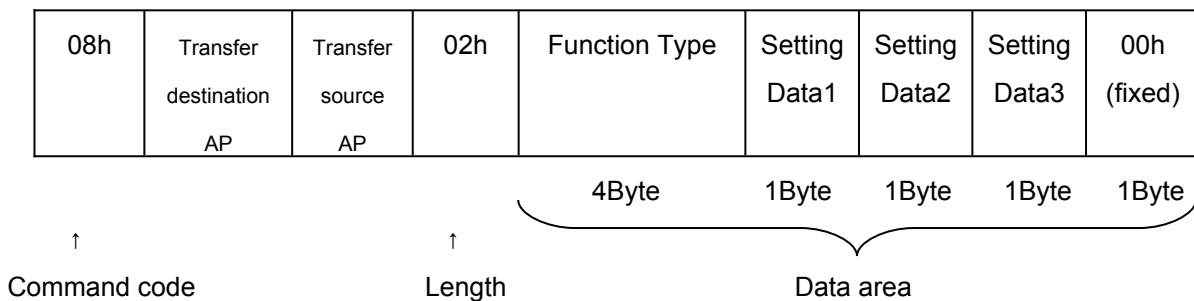

Fig. 6-7 Data Transfer Frame Composition During [End Adjustment]

Data area: Function type: 4Byte
 Setting 1 ~ Setting 3: 4Byte

The gain setting value is put into Setting Data1. The data is stored in a format like that in table 5-6 Relationship between Parameters and Gain. Setting Data 2,3 are unspecified. For detail please refer to the AR-Gun Command description.

Get Condition

Issuing authority: host
 Command code: 09h
 Data size: 01h
 Data area: Function type : 4Byte
 AR-Gun(00-00-00-20h) is specified.

Expected return value: [Data Transfer]

Description: Requests the physical status of the AR-Gun Function (buttons, keys, XY coordinates, etc). Used when reading the AR-Gun data.

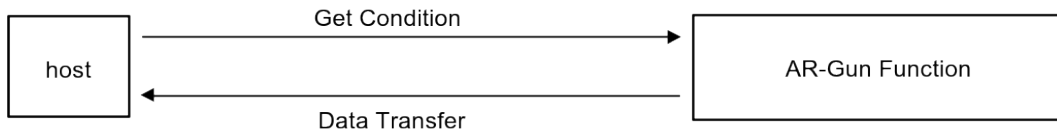

Fig. 6-8 Get Condition

Table 6-1 Host Transmission Data (Memory image)

Data Address	Data	Setting Ex.	Setting Explanation
+0000	Command code	09h	Specify [Get Condition]
+0001	Transfer destination AP	20h	Specifies port A device
+0002	Transfer source AP	00h	Transmits from port A
+0003	Data size	01h	Data size is 4 bytes
+0004	Function type	00h	Function type specifies [AR-Gun].
+0005		00h	
+0006		00h	
+0007		20h	

6.2 Special AR-Gun Command

This command is for the host to perform initial settings on the AR-Gun.

AR Control

Issuing authority: host
 Command code: 10h
 Data size: 02h
 Data area: Function type : 4Byte
 Specify AR-Gun(00-00-00-02h).
 Sub command: 1Byte
 Settings 1~3 : 3Byte

Expected return value: Handle sub command. See below.

Description: This command performs processing in response to the sub command to the transfer destination AP's AR-Gun Function. See below for detailed description on sub command.

10h	Transfer Destinati on AP	Transfer source AP	02h	Function type	Sub command	Setting 1	Setting 2	Setting 3
				4Byte	1Byte	1Byte	1Byte	1Byte

Fig. 6-9 Command Composition of the AR Control

Up to 255 types of sub commands can be registered, and the commands can be in the range of 01h ~FFh.

* 00h cannot be used.

Start Initialize

Issuing authority: host
 Sub command: 01h
 Setting 1: Monitor mode
 Setting 2: Unspecified
 Setting 3: Unspecified
 Expected return value: [Device Reply]
 Description: This command informs the AR-Gun that initial setting will be conducted. When this command is received, the AR-Gun conducts initialization setting. The reply to this command is [Device Reply].

Table 6-2 Start Initialize Sub Command

Sub Command	Monitor Mode	Setting 2	Setting 3
01h	See table 6-6	Undecided	Undecided

The command informs the AR-Gun Function the required monitor mode during initialization. There are two monitor modes: Normal and Wide. bit7~bit2 cannot be used.

Table 6-3 Monitor Mode Setting

Monitor Mode	bit1	bit0
Normal(4:3)	0	0
Wide(16:9)	0	1

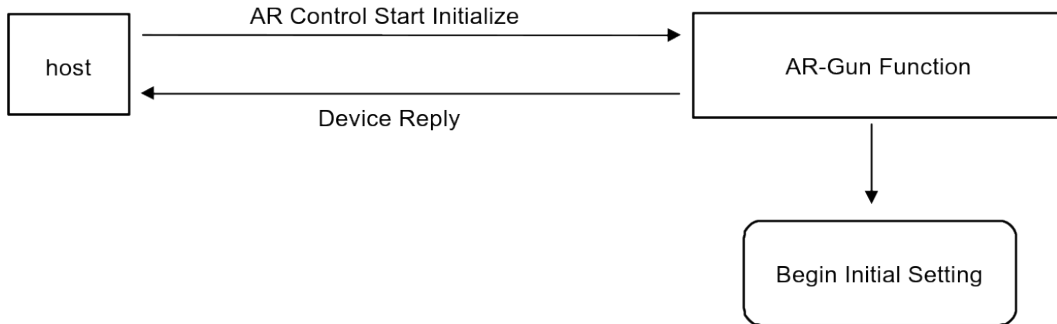

Fig. 6-10 AR Control Start Initialize

End Initialize

Issuing authority: host
 Sub command: 02h
 Setting 1: 00h
 Setting 2: 00h
 Setting 3: 00h
 Expected return value: [Device Error] during initialization, or [Data Transfer] when initialization is complete
 Description: This command is to confirm that the initialization setting of the AR-Gun has completed. When this command is received, if the AR-Gun has finished initialization, it returns the data set by [Data Transfer]. If the initialization is not complete or it did not successfully complete, (screen frame cannot be seen on monitor, etc) it returns an error command via [AR Error]. This confirmation at the end of initialization is sent for each transmission after [AR Control Start Initialize] is sent to the AR-Gun Function. This will continue until [Data Transfer] is returned from AR-Gun Function.

Table 6-4 End Initialize Sub Commands

Sub Command	Setting 1	Setting 2	Setting 3
02h	00h	00h	00h

Transmit Initialize Data

Issuing authority: host
 Sub command: 03h
 Setting 1: See table 6-9
 Setting 2: Unspecified
 Setting 3: Unspecified
 Expected return value: [Device Reply]
 Description: If initialization has been performed in the past, this command reads the setting data saved in VMS, and performs the setting based on this data.

Table 6-5 Transmit Initialize Data Sub Command

Sub Command	Setting 1	Setting 2	Setting 3
03h	See table 6-9	Unspecified	Unspecified

Bit 7 ~ bit 5 of Setting 1 are not used. Therefore, the setting values are 00H ~ 1FH. The values 20H ~ FFH are invalid.

Table 6-6 Relationship Between Parameters and Gain

Parameter				Total Gain (dB)	
bit3	bit2	bit1	bit0	bit4	
				0	1
0	0	0	0	14.0	20.0
0	0	0	1	15.5	21.5
0	0	1	0	17.0	23.0
0	0	1	1	18.5	24.5
0	1	0	0	20.0	26.0
0	1	0	1	21.5	27.5
0	1	1	0	23.0	29.0
0	1	1	1	24.5	30.5
1	0	0	0	26.0	32.0
1	0	0	1	29.0	35.0
1	0	1	0	32.0	38.0
1	0	1	1	35.0	41.0
1	1	0	0	38.0	44.0
1	1	0	1	41.0	47.0
1	1	1	0	45.5	51.5
1	1	1	1	51.5	57.5

6.3 Error Commands

AR-Gun Function supports only four types of error commands.

Transmit Again

Issuing authority:	host, AR-Gun Function
Command code:	FCh
Data size:	00h
Data area:	none
Description:	In the case where an error has occurred in data which is sent, it requests that the data be sent again. The AR-Gun Function data is always being updated, so when an error occurs, the data which is returned will not be limited to the contents of the read data.
Possible causes:	(1) Parity error occurred. (2) Data overflowed. (3) Data corruption during transmission. (4) Other.
Solutions:	Send once more (Maximum of three times. Further attempts will Time Out.)

Command Unknown

Issuing authority:	peripheral device
Command code:	FDh
Data size:	00h
Data area:	none
Description:	Issued when the received command is not supported in AR-Gun Function.
Possible causes :	(1) Command specification is incorrect. (2) Data statement is incorrect. (3) Device ID data is corrupt. (4) Data corruption during transmission.
Solutions:	(1) Use correct command specification (2) Use correct data statement . (3) Send [Device Request] once more and get the Device ID. (4) Try sending once more. (Maximum of three times. Further attempts will Time Out.)

Function Type Unknown

Issuing authority: peripheral device
 Command code: FEh
 Data size: 00h
 Data area: none
 Description: Issued when the function type sent does not belong to AR-Gun.
 Possible causes: (1) Function type specification is incorrect.
 (2) Data statement is incorrect.
 (3) Device ID data is corrupt.
 (4) Data corruption during transmission.
 Solutions: (1) Use correct function type specification.
 (2) Use correct data statement .
 (3) Send [Device Request] once more and get the Device ID.
 (4) Try sending once more. (Maximum of three times. Further attempts will Time Out.)

AR Error

Issuing authority: AR-Gun Function
 Command code: F9h
 Data size: 01h
 Data area: Function error code 4Byte
 Description: Returns an error command to the host when the initialization of the artificial retina is not complete and an [End Adjustment] is sent or if the initialization did not successfully finish.

Table 6-7 AR-Gun Function's Function Error Codes (Preliminary)

bit	7	6	5	4	3	2	1	0
1st Data	FE ₃₁	FE ₃₀	FE ₂₉	FE ₂₈	FE ₂₇	FE ₂₆	FE ₂₅	FE ₂₄
2nd Data	FE ₂₃	FE ₂₂	FE ₂₁	FE ₂₀	FE ₁₉	FE ₁₈	FE ₁₇	FE ₁₆
3rd Data	FE ₁₅	FE ₁₄	FE ₁₃	FE ₁₂	FE ₁₁	FE ₁₀	FE ₉	FE ₈
4th Data	FE ₇	FE ₆	FE ₅	FE ₄	FE ₃	FE ₂	FE ₁	FE ₀

Items for which an error was generated are set to "1" and items which had no errors are set to "0".

FE₀: Initialize Error (Initialization incomplete)

FE₁: Frame lines cannot be seen

FE₂: Frame lines are small

FE₃: Brightness is insufficient

* Other error codes are currently under consideration.

Solutions: (1) Wait for completion of initialization.
 (2) Display a message on the screen and prompt the user to change the settings.
 (Adjust the TV monitor's brightness setting. Adjust the TV monitor's distance and viewing angle.)

7 AR-Gun Function Information

This section describes the device specific information (device status). The device status data is saved as it is, and cannot be rewritten or erased.

Details of the Fixed Device Status are pending.

7-1 Types of Device Status

Fixed Device Status

This is a 112 byte format device status which must be written.

If all of the items are not described, no guarantee can be made for the operation and connection of the device.

Free Device Status

This device status may be used freely for individual devices.

It has a maximum capacity of 908 bytes.

7-2 Fixed Device Status

In the case of the Fixed Device Status, all of the following items must be described.

① Device ID

Capacity: 16byte

Description: Specifies the Device ID of the peripheral device.

② Region

Capacity: 16Byte

Description: Shows the product region (area where the product is sold).

Table 7-1 Composition of the Regional Setting Bit

bit	7	6	5	4	3	2	1	0
data	DES ₇	DES ₆	DES ₅	DES ₄	DES ₃	DES ₂	DES ₁	DES ₀

Table 7-2 Regional Setting Bit

Region	Setting Bit
North America Region	DES ₀ ='1'
Japan Region	DES ₁ ='1'
Asia Region	DES ₂ ='1'
Europe Region	DES ₃ ='1'
Reserved Region 1	DES ₄ ='1'
Reserved Region 2	DES ₅ ='1'
Reserved Region 3	DES ₆ ='1'
Reserved Region 4	DES ₇ ='1'

③ Connection direction

Capacity: 1Byte

Description: It differs for device and expansion devices. For device, it records direction of the expansion socket connecting the expansion device. For details, please refer to "[Maple Bus 1.0] Standard Specification."

④ Product Name

Capacity: 31Byte

Description: Lists the product name in English or Roman letters.
Written using half-width characters.
A space code (20h) is inserted for the remaining capacity.

⑤ License

Capacity: 60Byte

Description: Contains the product license display.
Written as "Produced By or Under License From SEGA ENTERPRISES, LTD".
A space code (20h) is inserted for the remaining capacity.

⑥ Standby Consumption Current

Capacity: 2Byte

Description: The Consumption Current during standby periods is written in base 16 in 0.1 mA units. For example, 10.5mA is written as 00-69h.

⑦ Maximum Consumption Current

Capacity: 2Byte

Description: The Maximum Consumption Current is written in base 16 in 0.1 mA units.
For example, 127.9 mA is written as 04-FFh.

7-3 Free Device Status

The Free Device Status can be used freely by the product planners, developers, designers, programmers, etc. and can be acquired by the host using [All Device Request].

When used in application software, it is necessary to have support for data parallels, etc.

For details, please refer to "[Maple Bus 1.0] Standard Specification."

8 Afterword

The contents of these specifications are subject to change in part or whole until the formal version is issued (Rev. 1.0)