

Get In Touch With Sega Software.

THE MEGA CARTRIDGE



• **Enduro Racer™**
The tracks are treacherous but you've got control with the on-road and off-road handling of this fast machine.



• **Alien Syndrome™**
Aliens have landed and your mission is clear: send them back from where they came. But they have super powers and you've got loads of courage, so take the upper hand (available mid-Fall).

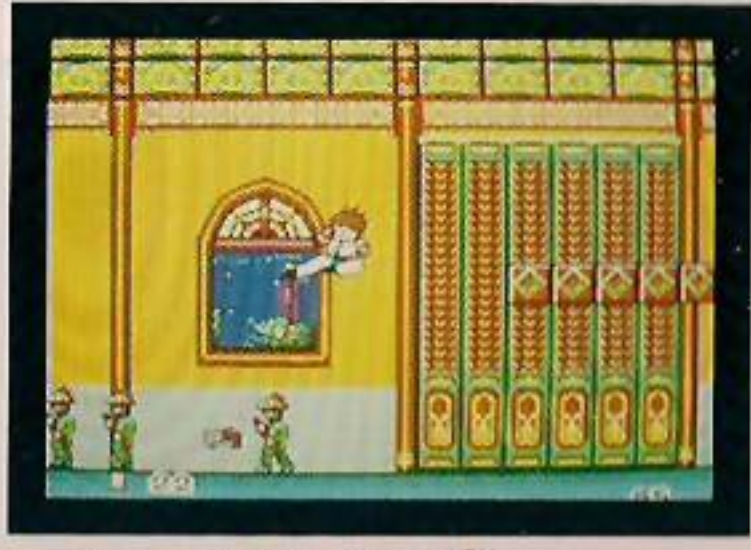

• **Kung Fu Kid™**
The wicked Madanda has just awakened from a sleep of several thousand years. Use your ancient talents to save your village from his terror.

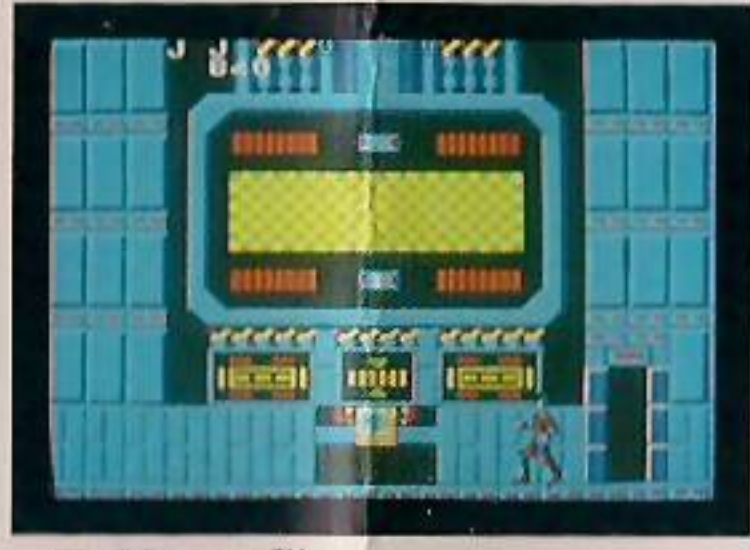

• **Zillion™**
Infiltrate the dangerous Norsa labyrinth to reach the main computer and rescue your friends. This game calls for brains as well as brawn.



• **Ghostbusters®***
If you can see them, blast 'em. Because Goza, The Master of Destruction, is ready to vaporize your city.

THE COMBO CARTRIDGE



• **Hang On™ Astro Warrior™**
First, ride the fastest motorcycle cross-country. Then, take to the stars for an out-of-this-world battle against evil (available only with the Sega Base System™).

THE SEGA CARD



• **Super Tennis™**
There's no love in this match. It's tough tournament play and you'll have to sizzle on court to win.

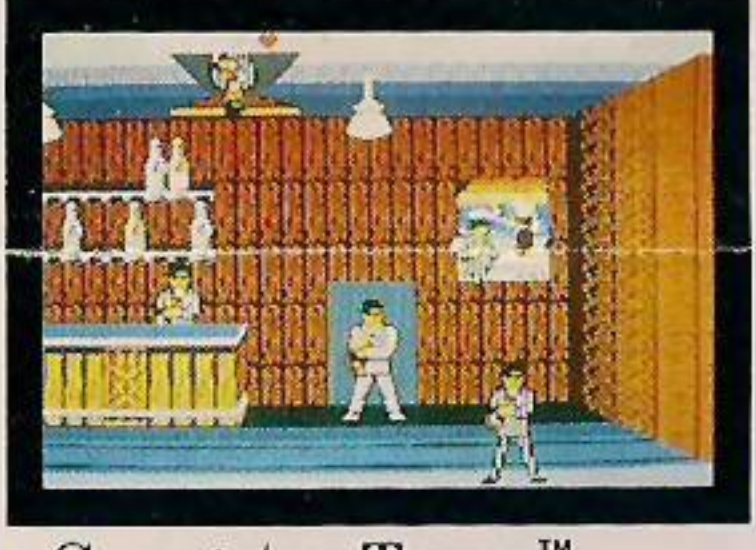

• **Gangster Town™**
You've teamed up with the FBI to rid the city of menacing thugs and send them to their final resting place. NOTE: Sega Light Phaser™ is required for play.



• **Shooting Gallery™**
Shoot down a speeding blimp, an iron clad spaceship or some pesky ducks. A steady hand and keen eye will bring you to the winner's stand. NOTE: Sega Light Phaser™ is required for play.



• **RAMBO™ First Blood™ Part II***
You're the original super hero, who's long on brute strength and short on patience. Your motto: Take no prisoners.

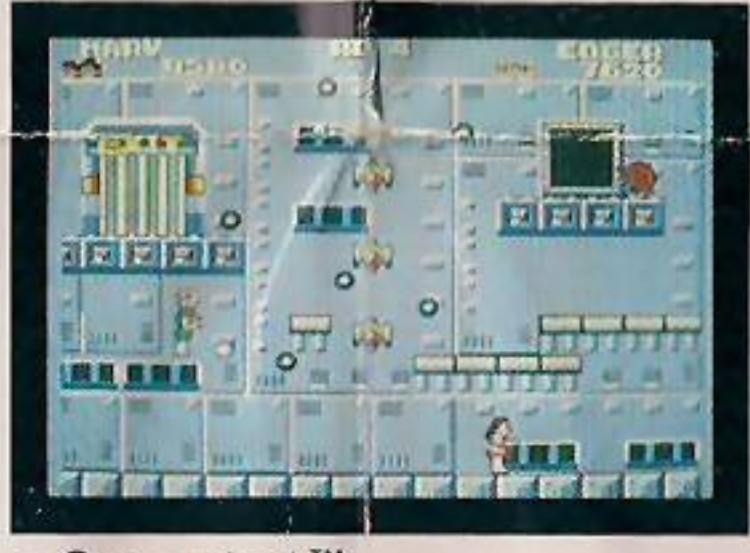

• **Quartet™**
You and your partner are locked in a maze. Find the key to exit and find yourself in a world of fun.



• **Wonder Boy™**
Great King has got your girl and you want her back. But a den of terror awaits. Snakes. Bats. Monsters. Is she worth it?



• **Hang On™ Safari Hunt™**
First, ride the fastest motorcycle cross-country. Then, join the wildest game hunt where it's a "real jungle out there" (available only with the Sega Master System™). NOTE: Sega Light Phaser™ is required for play.



• **F-16 Fighting Falcon™**
This perilous dog fight is between you, an F-16, and a MIG-25 plane. Wear a parachute, you may need it.



• **Alex Kidd In Miracle World™**
Save Radaction with your medallion of Sunstone. You're the only Kidd who can survive this adventure.



• **The Ninja™**
The tyrant Gyrokuro has your princess. Save her by using your traditional arsenal of secret weapons and skills.

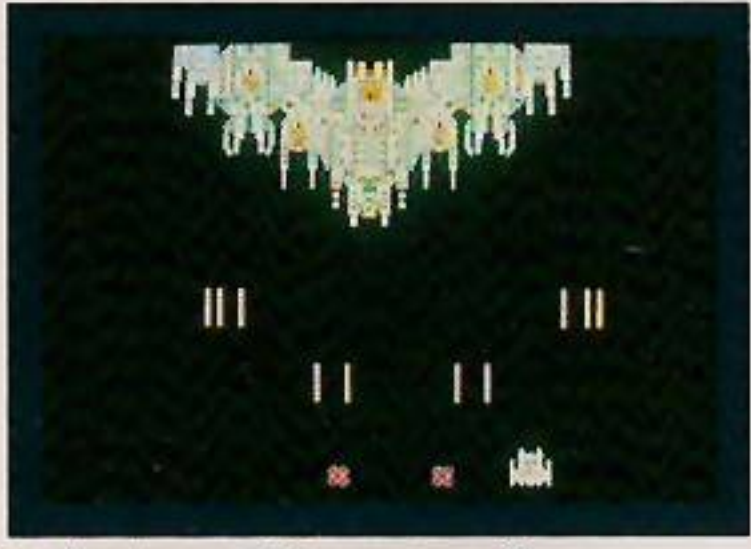

• **Astro Warrior™**
Your survival is threatened by a black universe full of enemy spaceships and dangerous warlords. You'll have to shoot straight, your life depends on it.

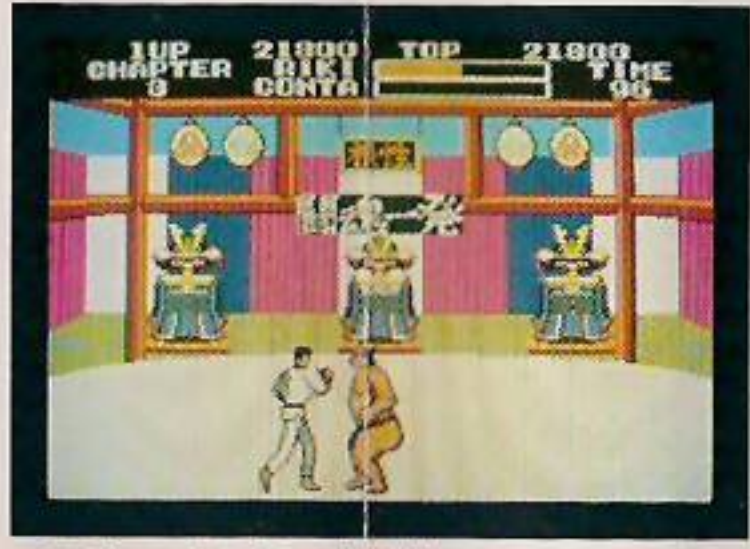

• **Black Belt™**
The world's been turned upside down by war and confusion is everywhere. Rely on your black belt skills and training to restore peace to a troubled planet.



• **Choplifter™***
Your mission is to rescue hostages from diverse and dangerous enemy camps. A barrage of bullets will greet you, but you must get through. Can you make it?

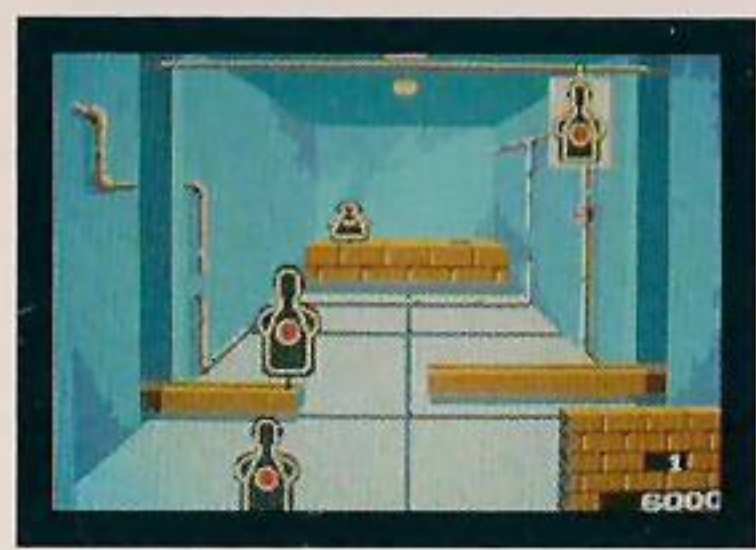

• **Marksman Shooting™ Trap Shooting™**
First, you're in training with the FBI. Then, you'll need split second reactions for skeet shooting. Aim well in both. NOTE: Sega Light Phaser™ is required for play.



• **Ghost House™**
You've just inherited the family jewels and you'll have to go up against Count Dracula to get them.

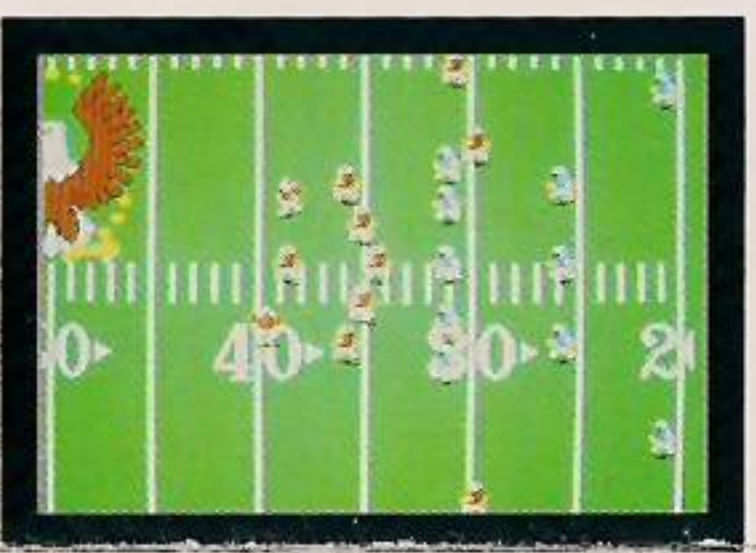

• **Great Football™**
Put on your shoulder pads for this game. It's as real as the NFL and just as tough to win.



• **World Grand Prix™**
World class auto racing on championship tracks. Feel the supercharged power and smell the burning rubber. The flag is dropped and you're off.



• **Fantasy Zone™**
A score of crazy-looking creatures greet you. But beware, in this day-glow colored world, they're as dangerous as they are funny.



• **Action Fighter™**
You're an international spy. Your prized weapon: a vehicle that transforms into deadly devices. Be brave and be bold.



• **Fantasy Zone II™**
Opa-Opa is at it again. Only this time the perils are greater and the rewards even better. Enter this zany world of characters again for real thrills and challenges (available mid-Fall).

THE 3-DIMENSIONAL MEGA CARTRIDGE



• **Missile Defense 3-D™**
The day has arrived for nuclear warfare. You're armed with the Eliminator and you must save the world. NOTE: Sega 3-D Glasses™ and Sega Light Phaser™ are required for play.

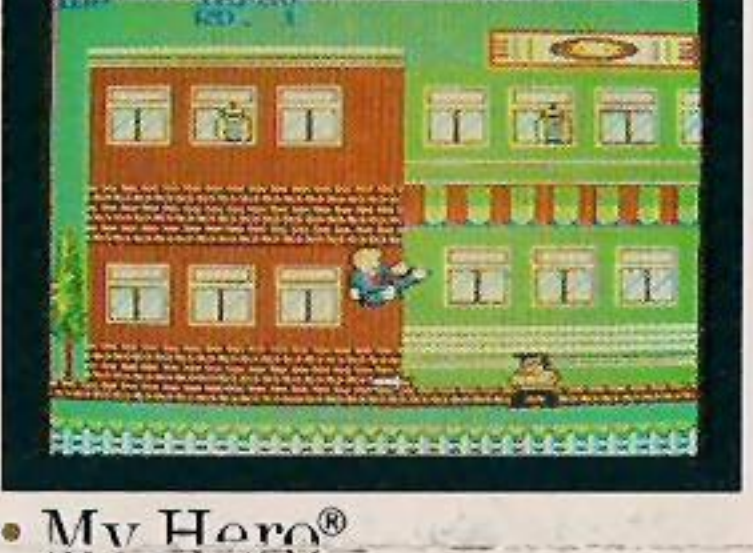

• **My Hero®**
A bunch of seedy punks try to get your girl. Battle knife throwers, bulldogs and bottles to keep them from getting her.



• **Great Golf™**
You'll need nerves of steel for this course. Because shrewd thinking and raw talent are your only allies in this calculating competition (available mid-Fall).

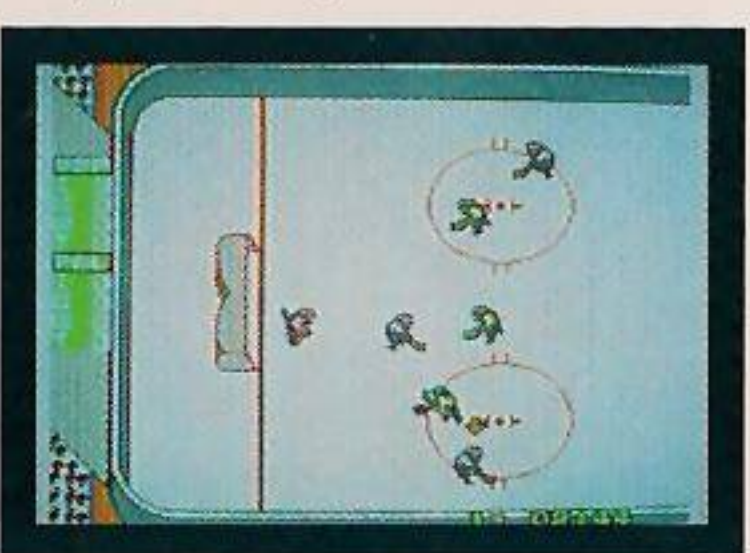

• **Great Ice Hockey™**
Welcome to the fastest competition on ice. This is League Hockey at its best, so be prepared for a rough but exciting time. NOTE: Sega Sports Pad™ is required for play.



• **Sports Pad Football™**
Designed for use with Sega Sports Pad™, you'll experience greater control and fast moving action on the old gridiron. NOTE: Sega Sports Pad™ is required for play.



• **Great Soccer™**
It's time to kick, dribble and pass your way to the goal. The competition is tough, but so is your defense.



• **Out Run™**
Experience speeds up to a simulated 270 kmh and the realistic sensation of driving. Keep both hands on the wheel and buckle up.

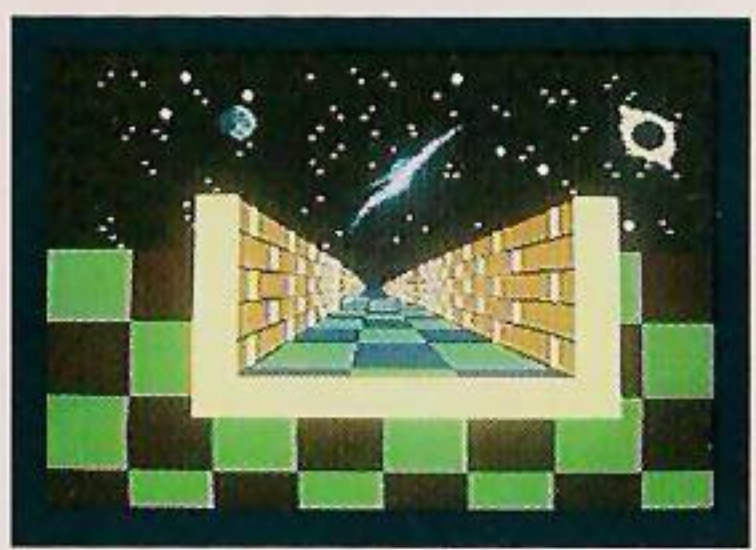

• **Zaxxon 3-D™**
In a maze of graphic shapes and obstacles, you'll have to shoot to survive and to win (available mid-Fall). NOTE: Sega 3-D Glasses™ and Sega Light Phaser™ are required for play.



• **TransBot™**
You're the only pilot left who can end the tyranny of Dalau, the evil intelligence computer. Depend on the power of your astroplane, it's all you have left.



• **Pro Wrestling™**
Try pinning Iron Soldier, Giant Bull or some other big bruiser. Go for body slams and pile drives. These guys are tough—but you're tougher.



• **Great Volleyball™**
The international competition is heavy. You'll have to serve, spike and outsmart the opposing team for victory.



• **Great Basketball™**
You don't have to be seven feet tall to compete in this arena of professional competition. But you will have to be quick, smart and agile to take the championship (available mid-Fall).



• **Rocky™***
Your dream is to be the best boxer the world has ever seen. Live the legend of Rocky.™



• **Teddy Boy®**
Scramble from maze to maze while knocking off guppies, snails and dominos. But avoid the ghastly Den Den, a snapping dragon, or he'll end your trip.



• **Great Baseball™**
Every play in the major league is brought to this diamond. So pitch, swing and steal bases like the pros. Play Ball!



• **Space Harrier™**
You're an extra-terrestrial warrior and you have the power to run, fly and shoot across a battlefield of dangerous attackers to save The Land of Dragons.

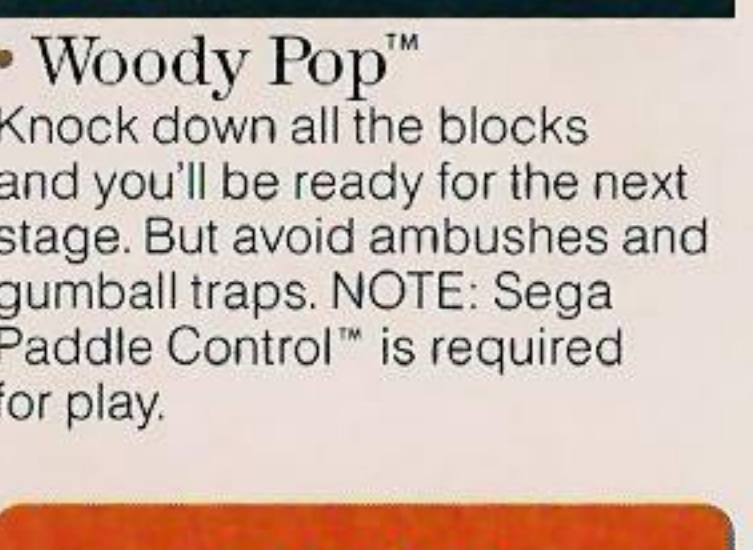

• **Woody Pop™**
Knock down all the blocks and you'll be ready for the next stage. But avoid ambushes and gumball traps. NOTE: Sega Paddle Control™ is required for play.

COMING SOON

MONOPOLY®
SDI™
Party Games™
Zillion II™
Combat & Rescue™

Now, there are no limits.®

SEGA®

*RAMBO™ First Blood™ Part II—™Trademark of Carolco International N.V. Stephen J. Cannell Productions, Licensing Agent ©1985 Carolco International N.V. All rights reserved. GHOSTBUSTERS®—™Trademark of Columbia Pictures Industries, Inc. Ghostbusters logo ©1984 Columbia Pictures Industries, Inc. All rights reserved. Licensed from Activision, Inc. Ghostbusters music and lyrics by Ray Parker, Jr. ©1984 Golden Torch Music Corp. and Raydiola Music Corp. ROCKY™—™Trademark of United Artists Pictures, Inc. ©1987 United Artists Pictures, Inc. All rights reserved. CHOPFLIFTER™—™This game software has been manufactured under license from Broderbund Software, Inc. ©Dan Gorlin, 1982. MONOPOLY®—™Trademark of ©1936, 1987 Parker Brothers.

Printed in Japan.

Take Hold Of The Sega Adventure[®]

