

Dreamcast™



REEL FISHING! Wild



NATSUME®
Serious Fun™



T-44303N

WARNINGS Read Before Using Your Sega Dreamcast Video Game System

CAUTION

Anyone who uses the Sega Dreamcast should read the operating manual for the software and console before operating them. A responsible adult should read these manuals together with any minors who will use the Sega Dreamcast before the minor uses it.

HEALTH AND EPILEPSY WARNING

Some small number of people are susceptible to epileptic seizures or loss of consciousness when exposed to certain flashing lights or light patterns that they encounter in everyday life, such as those in certain television images or video games. These seizures or loss of consciousness may occur even if the person has never had an epileptic seizure.

If you or anyone in your family has ever had symptoms related to epilepsy when exposed to flashing lights, consult your doctor prior to using Sega Dreamcast.

In all cases, parents should monitor the use of video games by their children. If any player experiences dizziness, blurred vision, eye or muscle twitches, loss of consciousness, disorientation, any involuntary movement or convulsion, **IMMEDIATELY DISCONTINUE USE AND CONSULT YOUR DOCTOR BEFORE RESUMING PLAY.**

To reduce the possibility of such symptoms, the operator must follow these safety precautions at all times when using Sega Dreamcast:

- Sit a minimum of 6.5 feet away from the television screen. This should be as far as the length of the controller cable.
- Do not play if you are tired or have not had much sleep.
- Make sure that the room in which you are playing has all the lights on and is well lit.
- Stop playing video games for at least ten to twenty minutes per hour. This will rest your eyes, neck, arms and fingers so that you can continue comfortably playing the game in the future.

OPERATING PRECAUTIONS

To prevent personal injury, property damage or malfunction:

- Before removing disc, be sure it has stopped spinning.
- The Sega Dreamcast GD-ROM disc is intended for use exclusively on the Sega Dreamcast video game system. Do not use this disc in anything other than a Sega Dreamcast console, especially not in a CD player.
- Do not allow fingerprints or dirt on either side of the disc.
- Avoid bending the disc. Do not touch, smudge or scratch its surface.
- Do not modify or enlarge the center hole of the disc or use a disc that is cracked, modified or repaired with adhesive tape.
- Do not write on or apply anything to either side of the disc.
- Store the disc in its original case and do not expose it to high temperature and humidity.
- Do not leave the disc in direct sunlight or near a radiator or other source of heat.
- Use lens cleaner and a soft dry cloth to clean disc, wiping gently from the center to the edge. Never use chemicals such as benzene and paint thinner to clean disc.

PROJECTION TELEVISION WARNING

Still pictures or images may cause permanent picture tube damage or mark the phosphor of the CRT. Avoid repeated or extended use of video games on large-screen projection televisions.

SEGA DREAMCAST VIDEO GAME USE

This GD-ROM can only be used with the Sega Dreamcast video game system. Do not attempt to play this GD-ROM on any other CD player; doing so may damage the headphones and/or speakers. This game is licensed for home play on the Sega Dreamcast video game system only. Unauthorized copying, reproduction, rental, public performance of this game is a violation of applicable laws. The characters and events portrayed in this game are purely fictional. Any similarity to other persons, living or dead, is purely coincidental.

REBEL FISHING | WILD

Contents

Getting Started.....	4
Controls.....	6
Introduction.....	8
Fishing Lodge Overview.....	9
Fishing Lodge - Main Room.....	10
Fishing Lodge - Stock Corner.....	12
Optimize Your Chances for Success.....	13
Fish the World.....	14
Tips for Catching Fish.....	22



Getting Started...

1. With the Sega Dreamcast power off, insert the Reel Fishing® I Wild disc into the Sega Dreamcast.
2. Plug your Sega Dreamcast controller into Control Port A. If you are using the Sega Dreamcast Fishing Controller (sold separately), plug the Fishing Controller into Control Port A and a Standard Controller into any empty Control Port.
3. Insert your VMU (sold separately) into the Standard Controller.
4. Press the Power Button to activate your Sega Dreamcast.

SEGA DREAMCAST HARDWARE UNIT

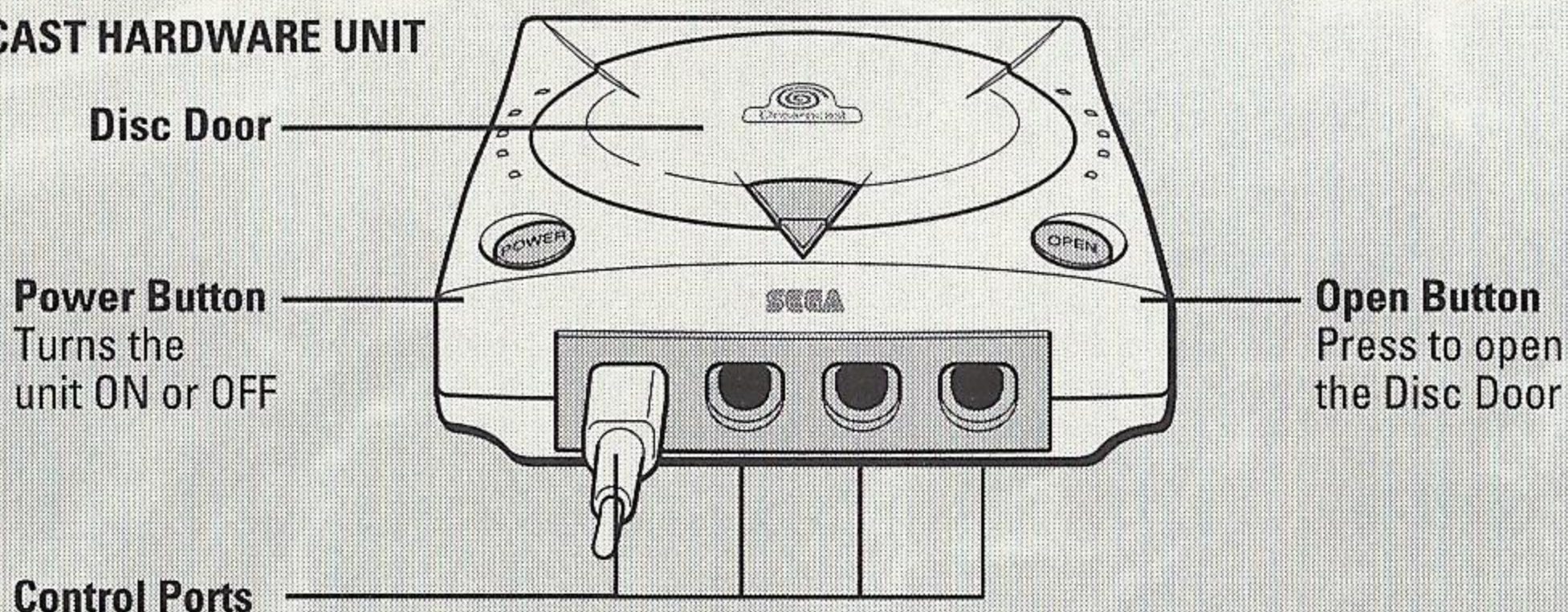

Power Button
Turns the
unit ON or OFF

Open Button
Press to open
the Disc Door

Control Ports

Use these ports to connect your Dreamcast Controller or other peripheral equipment like the Fishing Controller. From left to right are **Control Port A, Control Port B, Control Port C and Control Port D.**

Note:

Reel Fishing® I Wild is a 1-player game. Before turning the Sega Dreamcast Power ON, connect the controller or other peripheral equipment into the control ports of the Sega Dreamcast.

To return to the title screen at any point during gameplay, simultaneously press and hold the **A, B, X, Y** and **Start** buttons. This will cause the Dreamcast to soft-reset the software.

New Game

To begin a new game, select NEW GAME at the title screen. You'll see a menu where you can enter a name for your VMU save file. Reel Fishing® I Wild is a large game so it's recommended that you use a VMU to save your hard-earned tackle and newly opened areas.

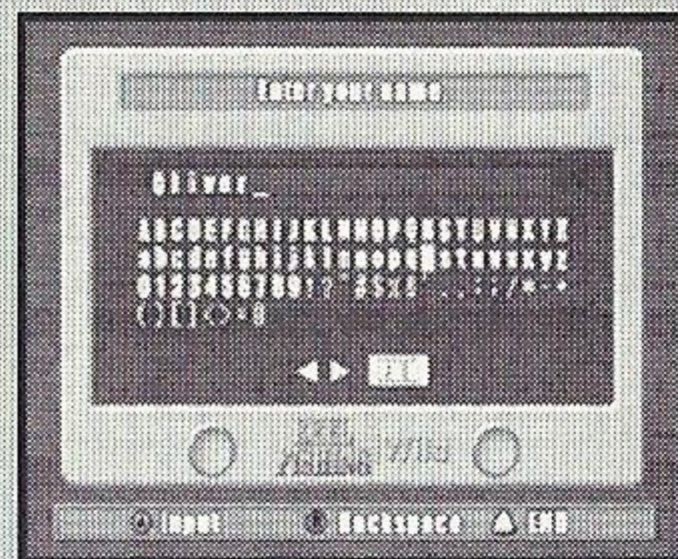

Load Game

To load a game, select LOAD GAME at the title screen. You'll see a display of the controllers plugged into your Sega Dreamcast and the VMUs. Highlight the controller with the VMU containing your saved progress and press the A Button. The game will search for a file and load it.

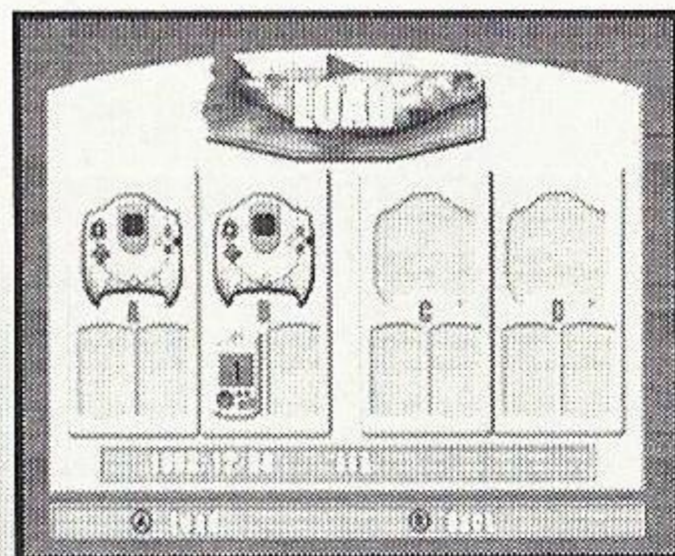

Using the Sega Dreamcast Jump Pack™ (sold separately)

The vibrating Jump Pack indicates when a fish strikes your lure as well as the amount of tension on your fishing line while playing a fish. While this controller accessory is not necessary for playing the game, it will make your fishing experience far more realistic and easier to play.

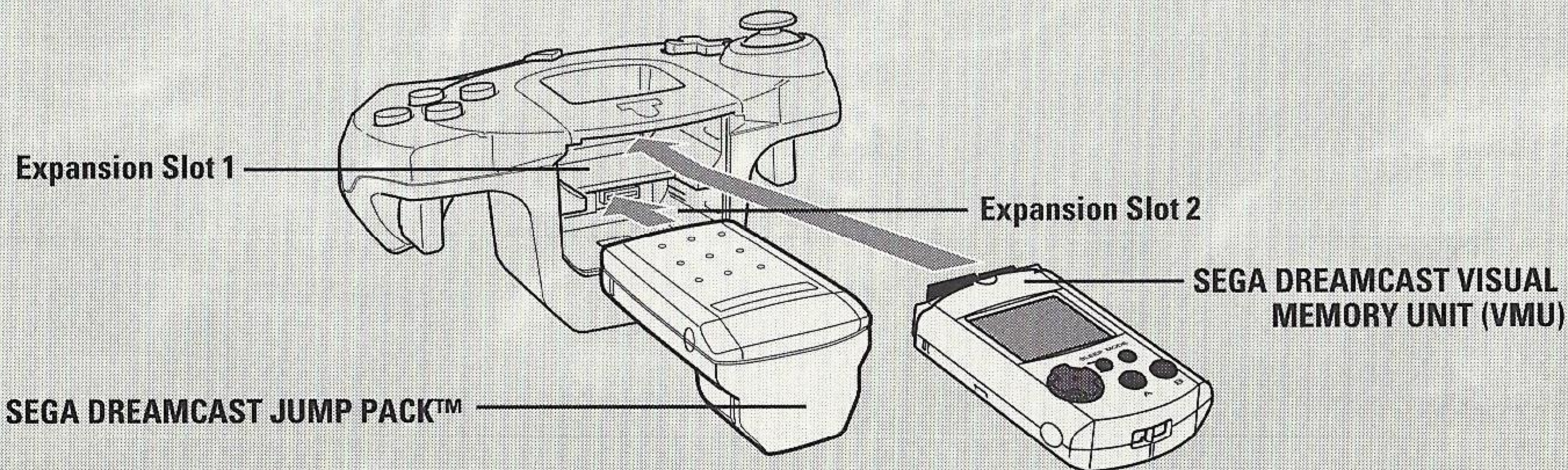

Note:

When the Jump Pack is inserted into Expansion Socket 1 of the Sega Dreamcast Controller, the Jump Pack connects, but does not lock. If the controller is jarred, the Jump Pack may fall out during game play or otherwise inhibit game operation.



Controls...

Sega Dreamcast Controller

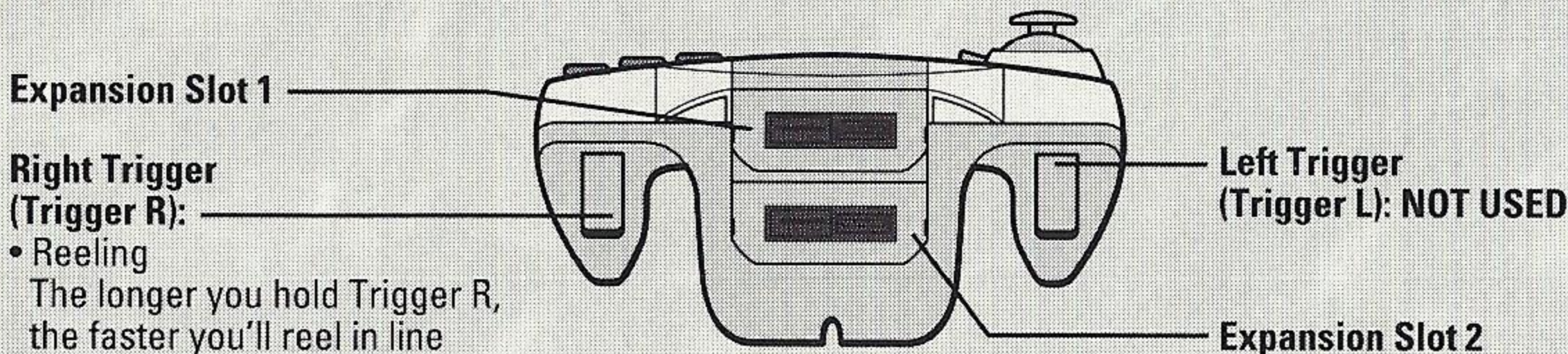
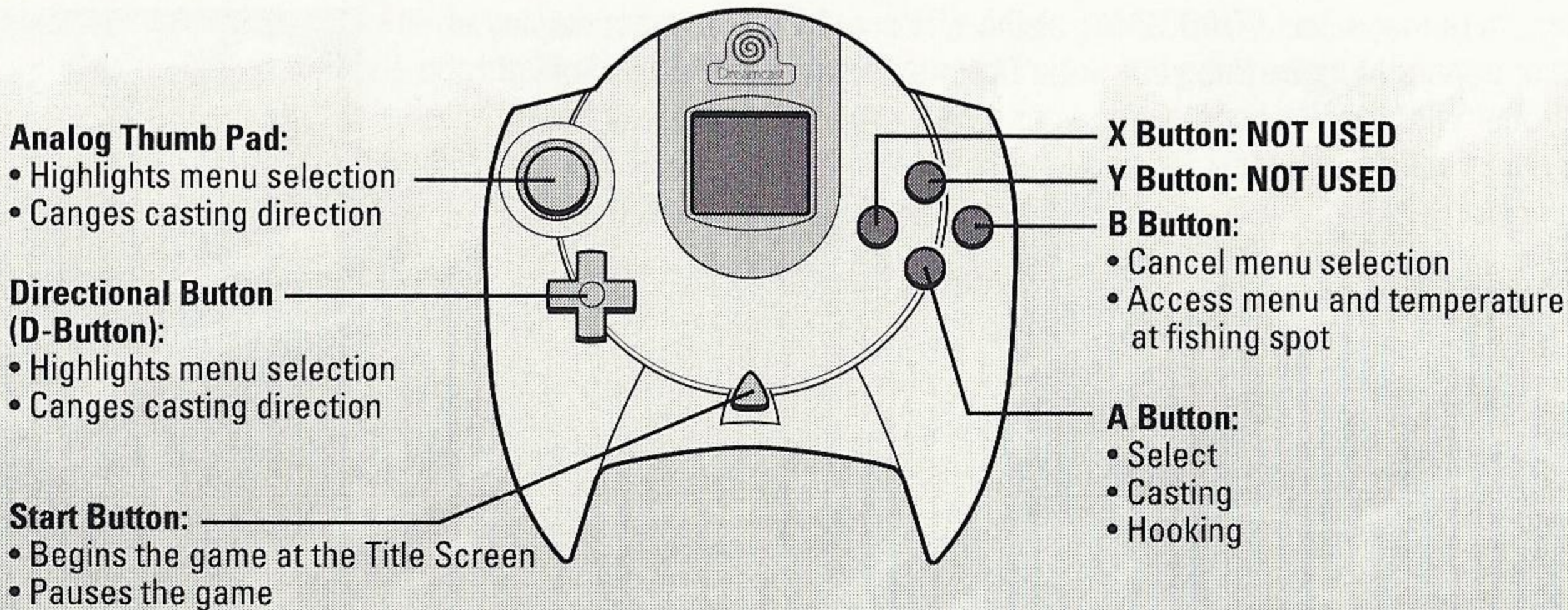

Note:

Never touch the Analog Thumb Pad or Triggers L/R while turning the Sega Dreamcast power ON. Doing so may disrupt the controller initialization procedure and result in malfunction.

If the Analog Thumb Pad or Trigger L/R are accidentally moved while turning the Sega Dreamcast power ON, immediately turn the power OFF and then ON again making sure not to touch the controller.



Sega Dreamcast Fishing Controller (sold separately)

While the Fishing Controller isn't required to play Reel Fishing® | Wild, it will enrich your game play experience and make it easier to land fish. The Fishing Controller has a built-in vibration feedback that indicates strikes and line tension, allowing you to play the fish more effectively.

Motion Sensor

Instead of using the A Button to cast, swing the Fishing Controller forward as you would cast with a fishing rod. An internal motion sensor measures the speed of the cast, which is calculated into how far the lure travels based on the rod equipped.

Start Button:

- Begins the game at the Title Screen
- Pauses the game

X Button: NOT USED

A Button:

- Select
- Casting
- Hooking

B Button:

- Cancel menu selection
- Access menu and temperature at fishing spot

Analog Thumb Pad:

- Highlight menu selection
- Changes casting direction

Reel Handle:

- Reel in line
- The quicker you turn the reel handle, the faster you'll reel in line

Y Button: NOT USED

Note:

To prevent the Fishing Controller from being thrown when casting or hooking, be sure to grasp the Fishing Controller firmly with your finger on the hook on the rear of the controller.

Introduction

While the term “Reel Fishing” might sound like a clever play on words, Reel Fishing® | Wild is the closest thing you’ll find to reality without getting your waders wet. You’ve no doubt heard of flight simulators. This is a fishing simulator—one of the best around. As in real life, the big fish in this game didn’t grow large making dumb mistakes. Think like a fish and the only fish you’ll catch are small, inexperienced fry. To earn new tackle, uncover new fishing areas and catch the biggest fish around, you’ll need to think like prey. Reel Fishing® | Wild is so realistic that as you learn new strategies, you’ll find that you can apply some of them at your favorite fishing hole.

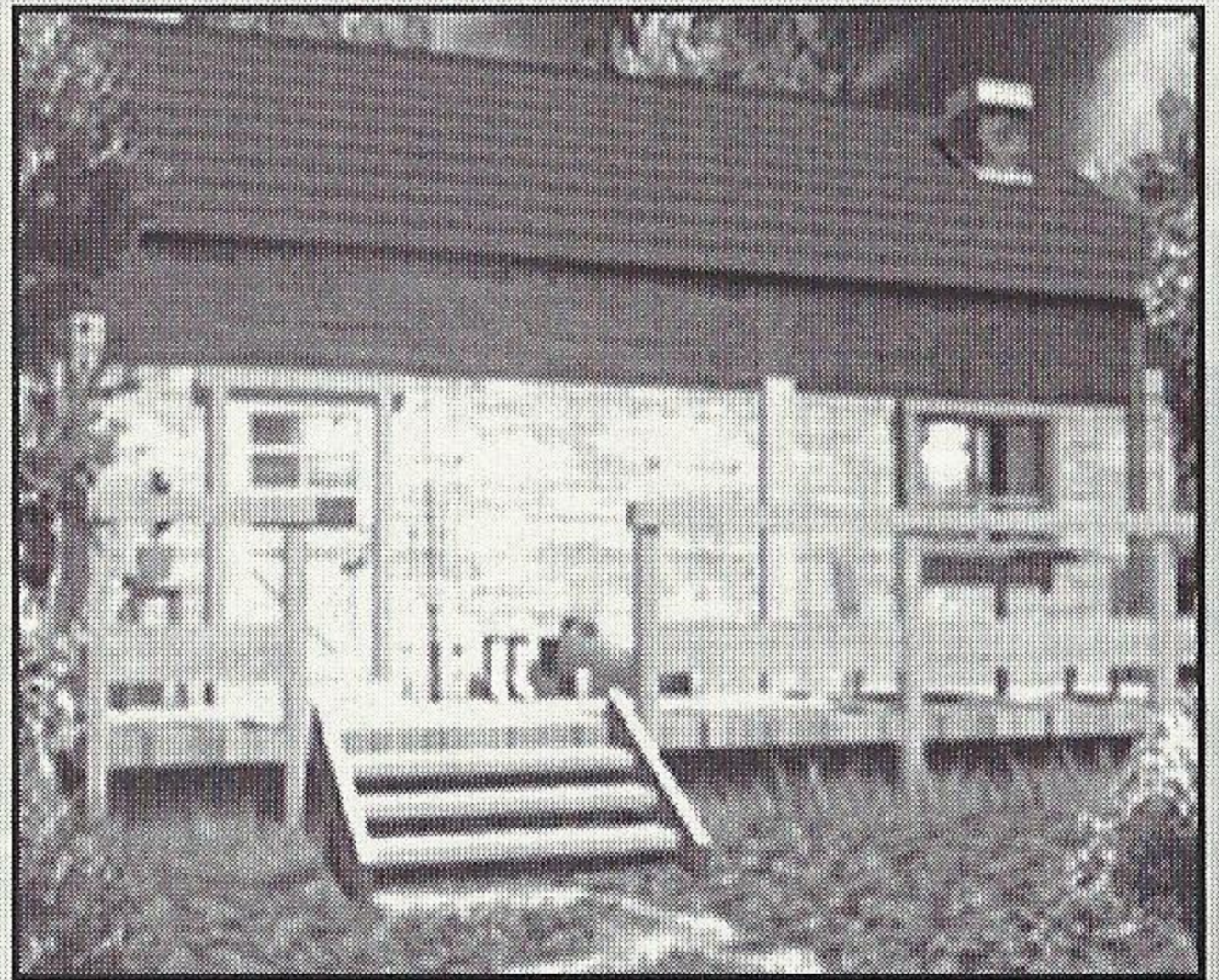
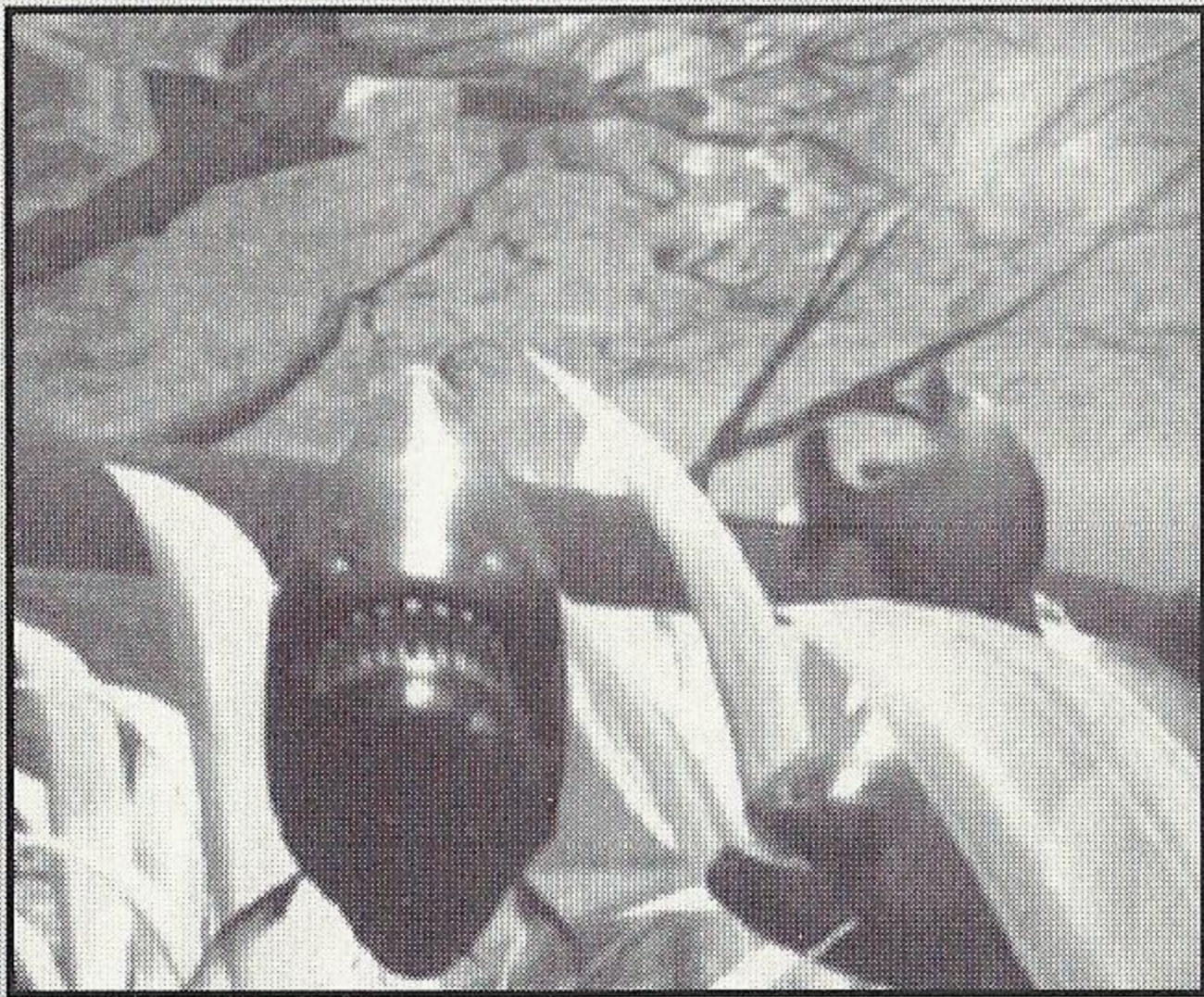

Fishing Lodge Overview

Every great fishing adventure begins within the walls of the rustic Reel Fishing® | Wild Fishing Lodge. Your room contains all of your rods, reels, lines and lures, plus important records of all of your greatest freshwater catches (including statistics on some of the ones that got away.)

Main Room

Catch List
(see page 11)

Option Menu
(see page 10)

To Stock Corner
(see page 12)

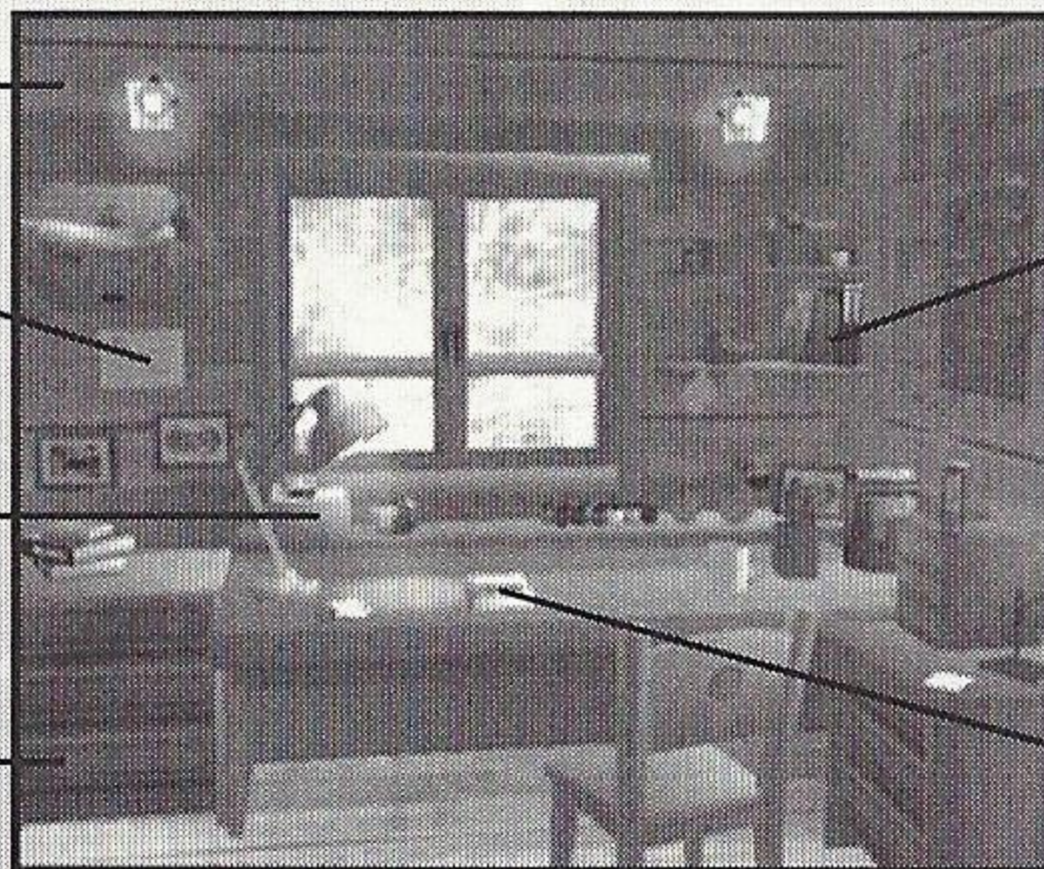

Fish Glossary
(see page 17)

Fishing Notebook
(see page 10)

Stock Corner

Rods
(see page 12)

Reel and Line
(see page 12)

Lure
(see page 12)

Return to Main Room

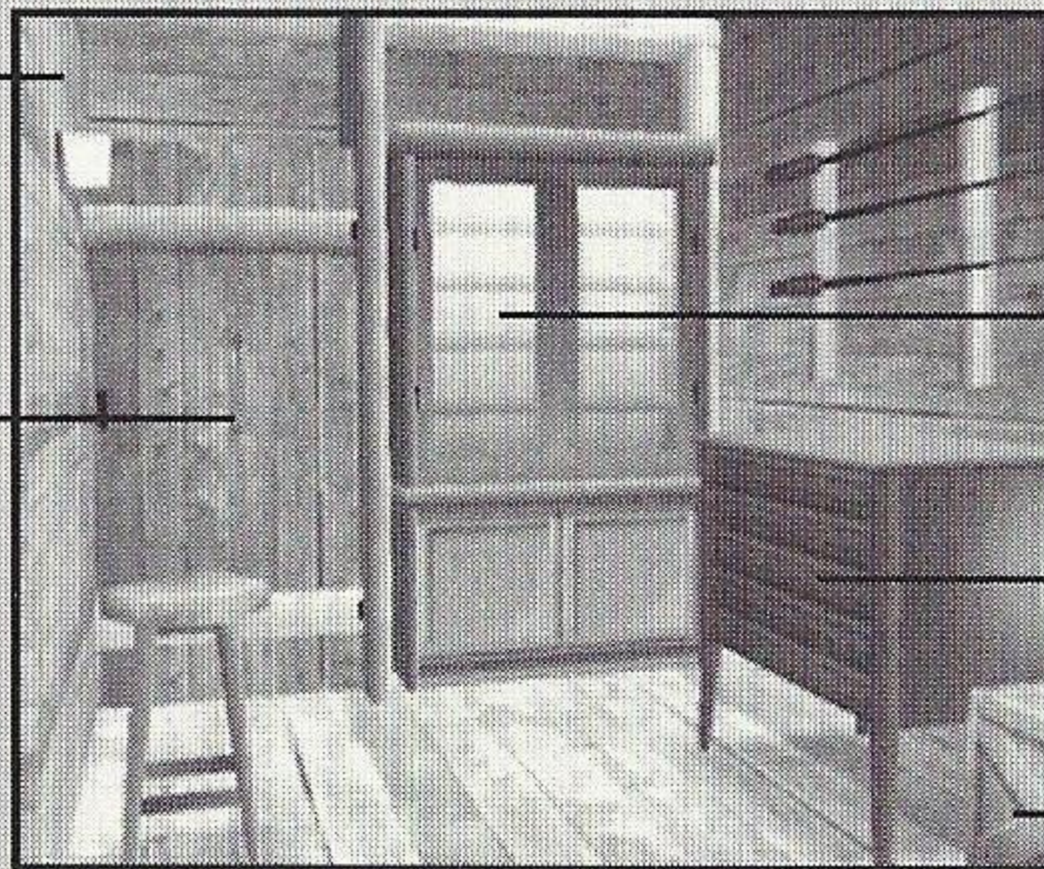

Fishing Lodge - Main Room

Option Menu

Highlight the box with the photo on the desk and press the A Button to access Reel Fishing® I Wild's Option menu. Push the Analog Thumb Pad or press the D-Button to adjust the audio between stereo or mono, turn off the background music or deactivate the vibration feedback on your controller. Some anglers prefer the music off for the ultimate virtual fishing experience.

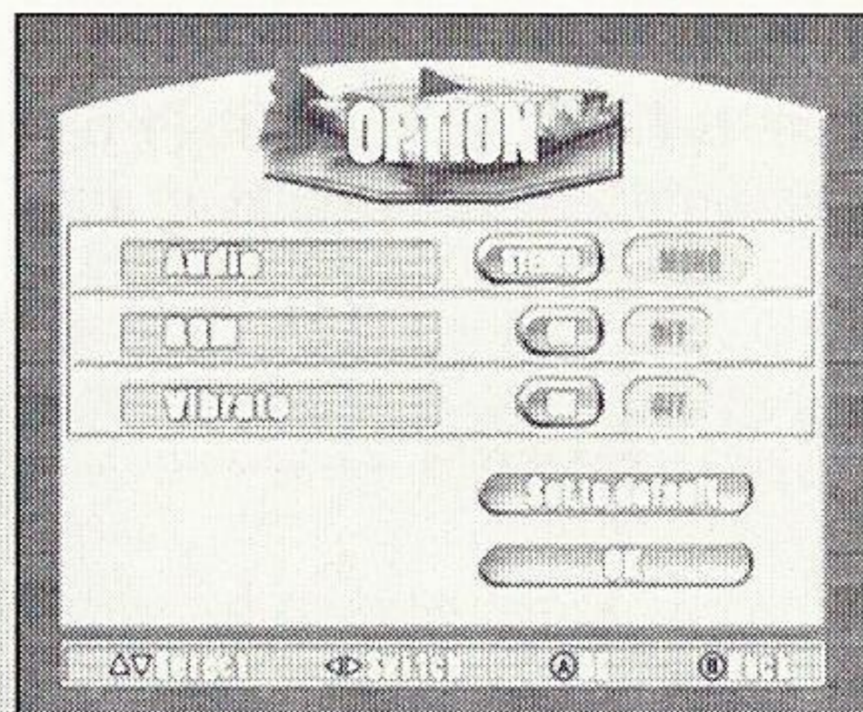

Your Fishing Notebook

To begin fishing, open your fishing notebook. Like all beginning anglers, the first time that you open your fishing notebook you won't see many entries, but you'll gradually fill up your book as you catch certain fish and meet specific criteria. The first time you play Reel Fishing® I Wild, you'll only be able to access the Japanese Stream. If you select "Japan/Stream" and press the A Button, you'll see a list of target fish. These are the fish that you'll need to catch to open the next fishing area. To add a bit of mystery to the challenge, the game doesn't tell you the sizes or number of the fish you need to catch, but if you want to know you can peek at the fishing spot information in the back of this manual. You can also use your fishing notebook to load or save your progress.

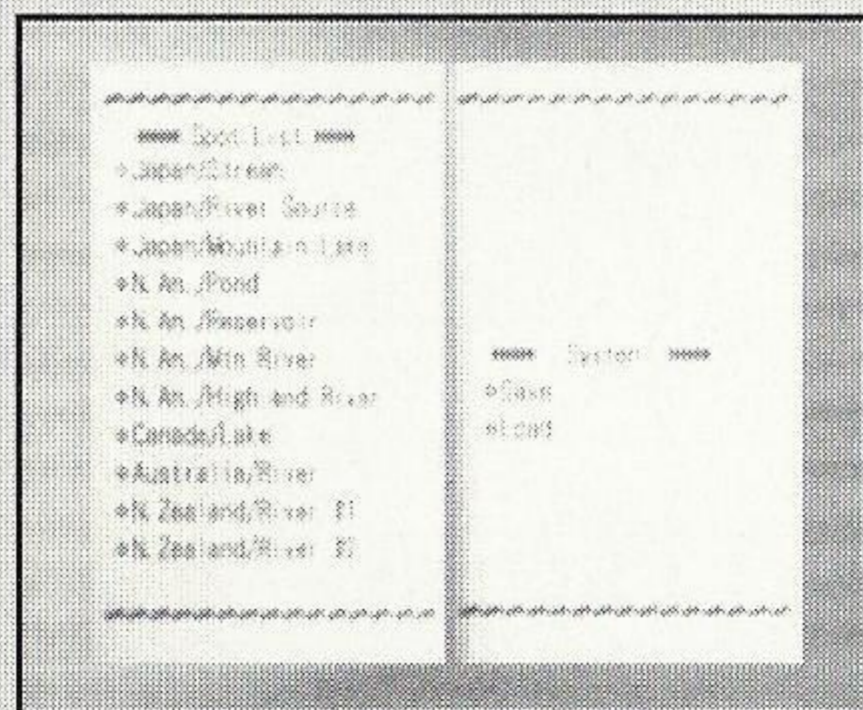

If you're looking for specific information about fishing spots, see the guide on page 14.

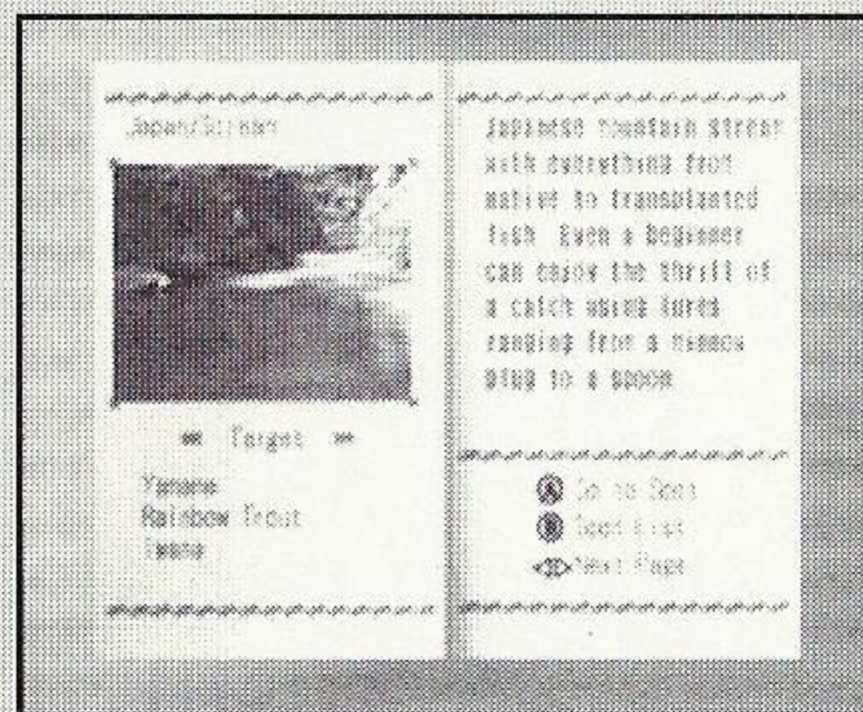

Your Fishing Glossary

Whenever you catch a new species of fish, that particular species appears under a new heading in your fishing glossary. Besides providing a basic overview of the fish, the fishing glossary lists the largest fish caught and features a complete summary of the nibbles, strikes and catches you've made for that particular species. The fishing glossary is a valuable tool for determining the quantity and sizes of the target fish you need to catch to open the next fishing area.

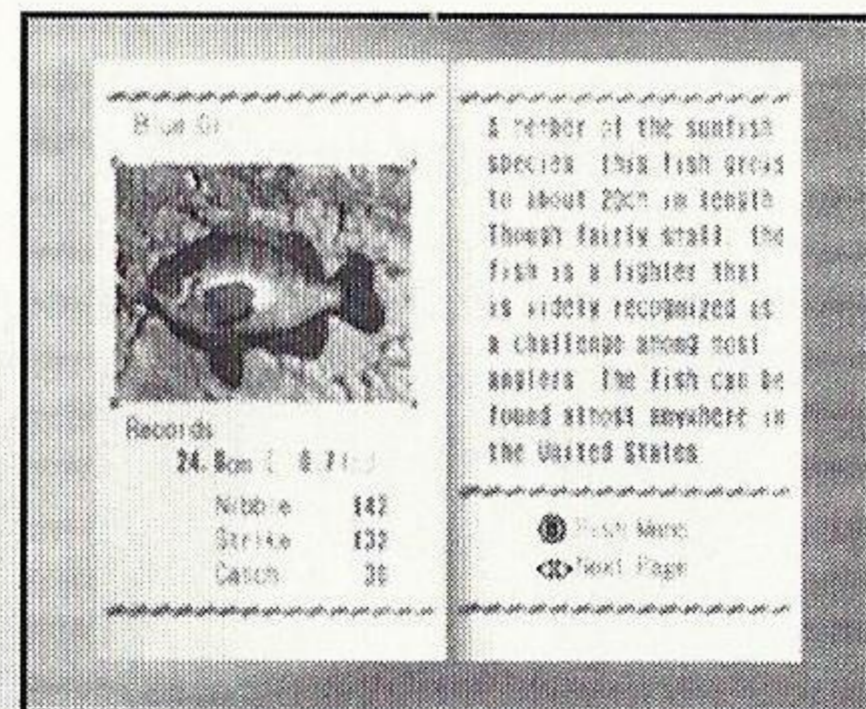

Your Catch List

Your catch list is a complete log of your best trophy catches. The rows of question marks indicate fish species that you have not caught yet. If you highlight a fish name in the list and press the A Button, you'll see your ten largest catches for that species. Each listing also notes the rod, reel, lure and environmental conditions during the catch.

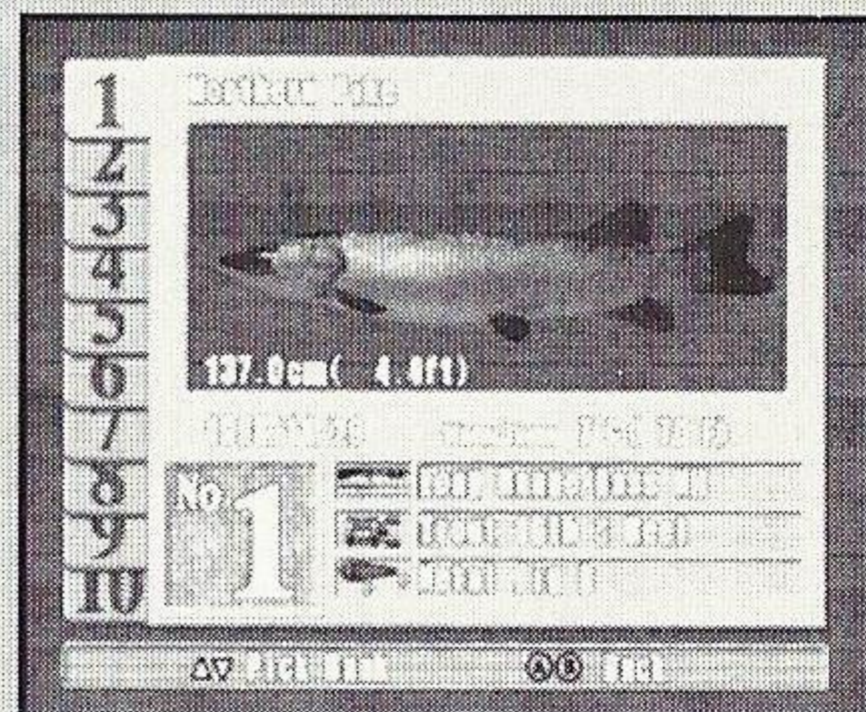

Fishing Lodge - Stock Corner

Lure

You can review your lure collection in the stock corner. You'll earn better lures as you catch fish. In fact, after you open a new area you'll often have to catch other fish besides the target species to eventually earn the lure you'll need to move on to the next area.



Reel and Line

Check your reel and line collection in the stock corner periodically to make sure that you're using the equipment out on the water. Like the lures in the game, you'll earn better reels and line as you catch more fish. Heavy test line is essential for landing monster fish.

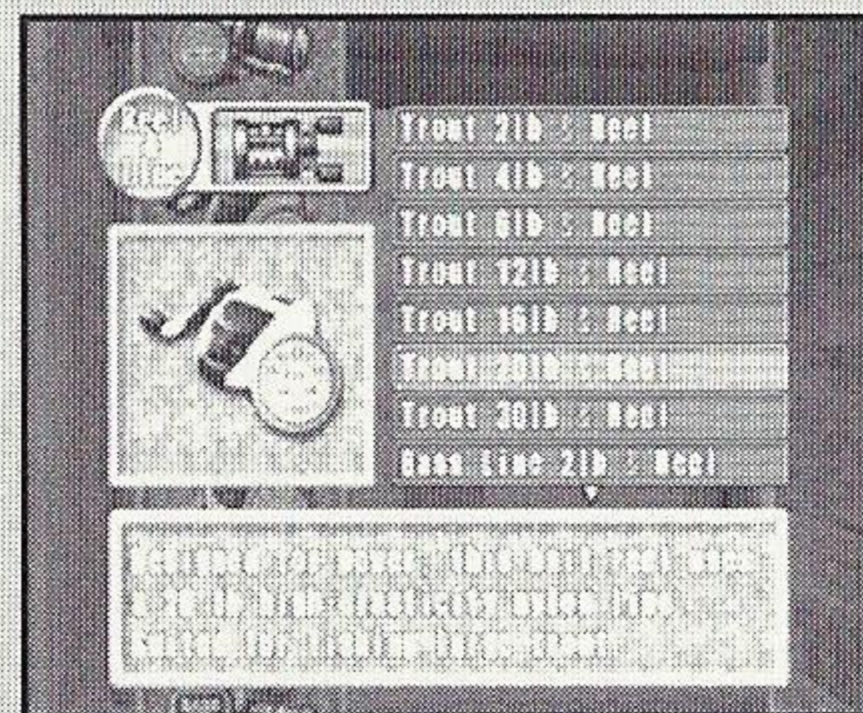

Rod

Quality rods provide the casting power you'll need to reach remote fish, especially when you begin fishing the North American stillwater areas. Qualities like long distance and pinpoint accuracy are rarely found on the same rod, so swap equipment frequently for best results.

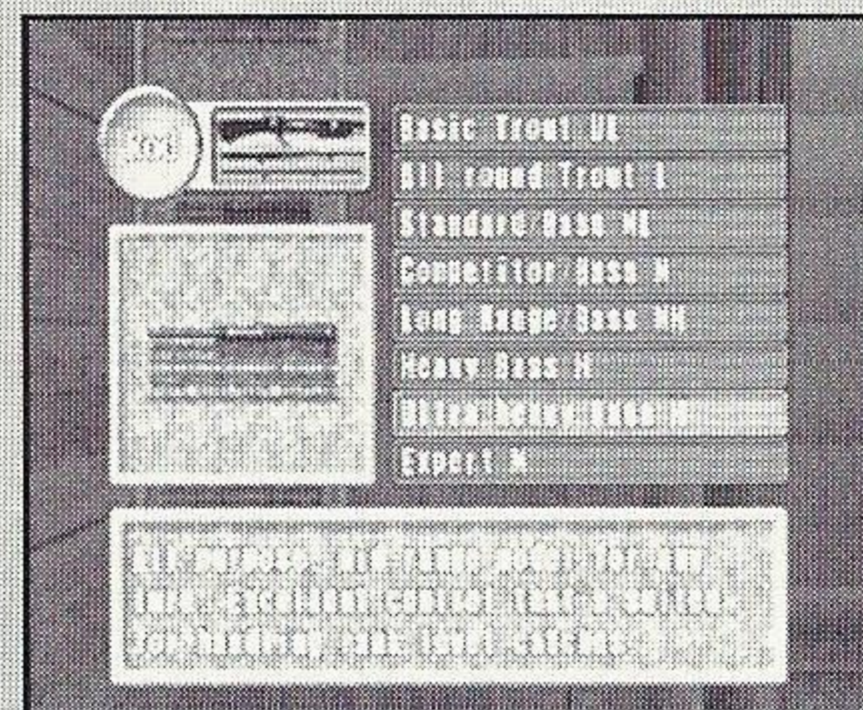

Optimize Your Chances for Success

You've picked the fishing spot and you're ready to start landing fish, right? Maybe-if you're very lucky. Before you begin casting, take a moment to tilt the odds in your favor by checking out a couple important features in the game. A little preparation will add extra fish to your catch list.

Monitor the Water Temperature

Fish are cold-blooded creatures with metabolisms that are linked to water temperature. If the water is too cold or too hot, some species become dormant or won't eat. The color-coded climate information helps tell you if fish are active. Red indicates the best conditions, white means that the conditions are average and blue means that the fish are not very active. If conditions remain less than appealing, consider waiting for the temperature to change by selecting "Quit Fishing" (choose "Yes" to confirm) and returning to the fishing lodge. Conditions usually improve as you fish, but not always.



How to Change your Tackle

Does your target fish dredge food off the bottom or sip prey from the surface? Before you cast, press the B Button, highlight the "Change Tackle" option and press the A Button. Doing this will display a menu showing your selected rod, reel, line and lure. Pressing the A Button again will bring up all the lures in your inventory. Push the Analog Thumb Pad left or right to rotate through your lures. Beneath each lure you'll find important information relating to how the lure is used while fishing. Press the A Button again to choose the desired lure, then do the same thing for the rest of your tackle.



Fish the World

Japan, America, Canada, Australia, New Zealand, South America: You've got places to go and fish to catch. These pages contain tips for catching target fish and accessing new areas. **If you want to find out on your own, don't read beyond this page!** If you have trouble fishing, skip to page 22.

How to Earn New Tackle

While you start out with a small inventory of tackle, as you catch fish, you'll add more equipment to your inventory. Catching the smaller fish in the fishing spot will eventually earn you tackle that you can use to catch the larger target species. Because fish in certain regions are selective about the food they eat, you'll have to carefully choose the correct lure, rod, reel and line to catch your target fish.



Japanese Mountain Stream

Stocked nearly to the point of overpopulation, the Japanese Mountain Stream is one of the best places to hone your angling skills. While you won't catch the biggest fish in the game here, you'll learn how to hook and land fish and acquire important tackle for later stages.

Target Species:

- Yamame
- Rainbow Trout
- Iwana

To Access:

- This is the first place you can fish in the game.

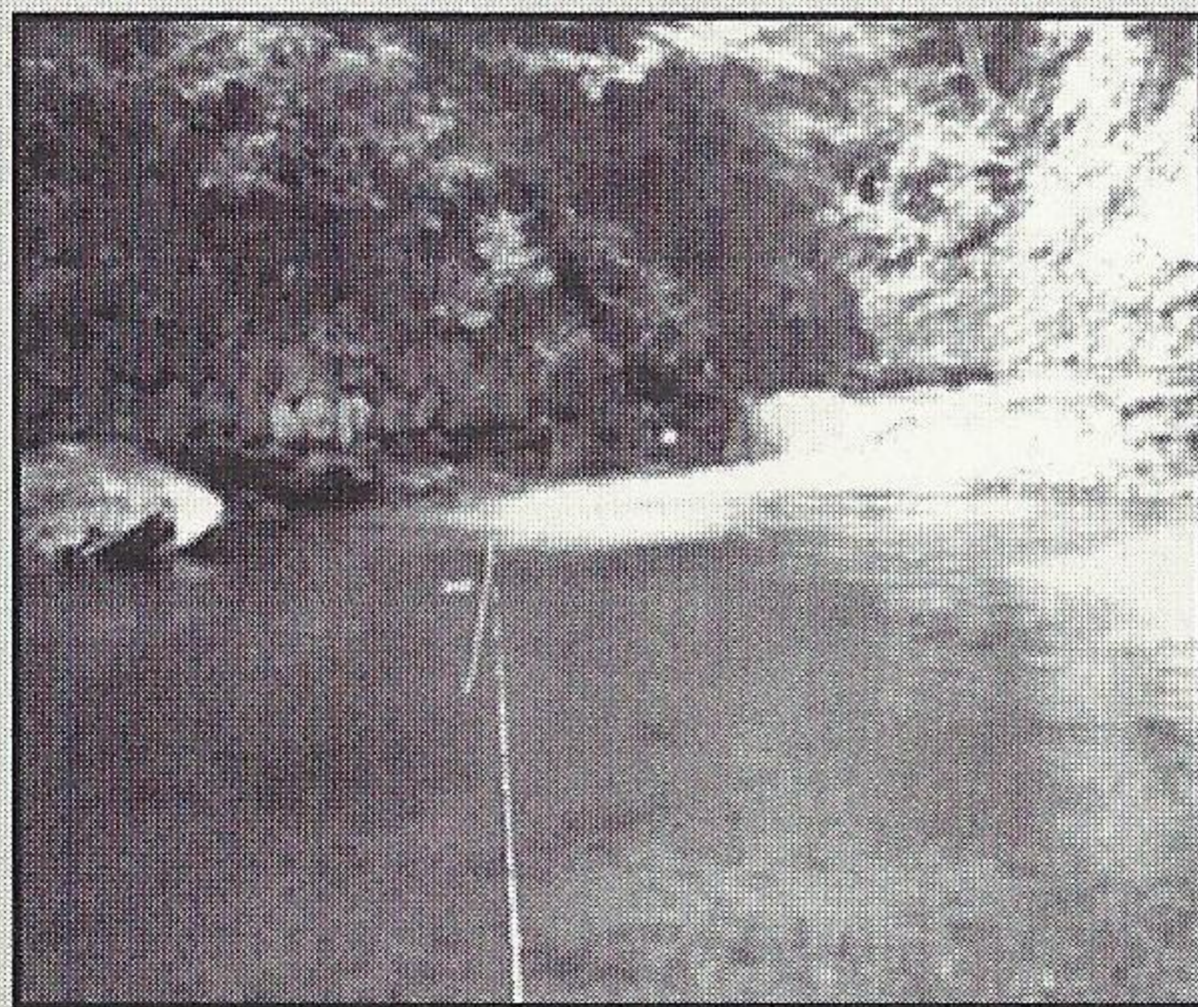

il

—

—

—

W

—

?

It

ir

—

rs

f

u

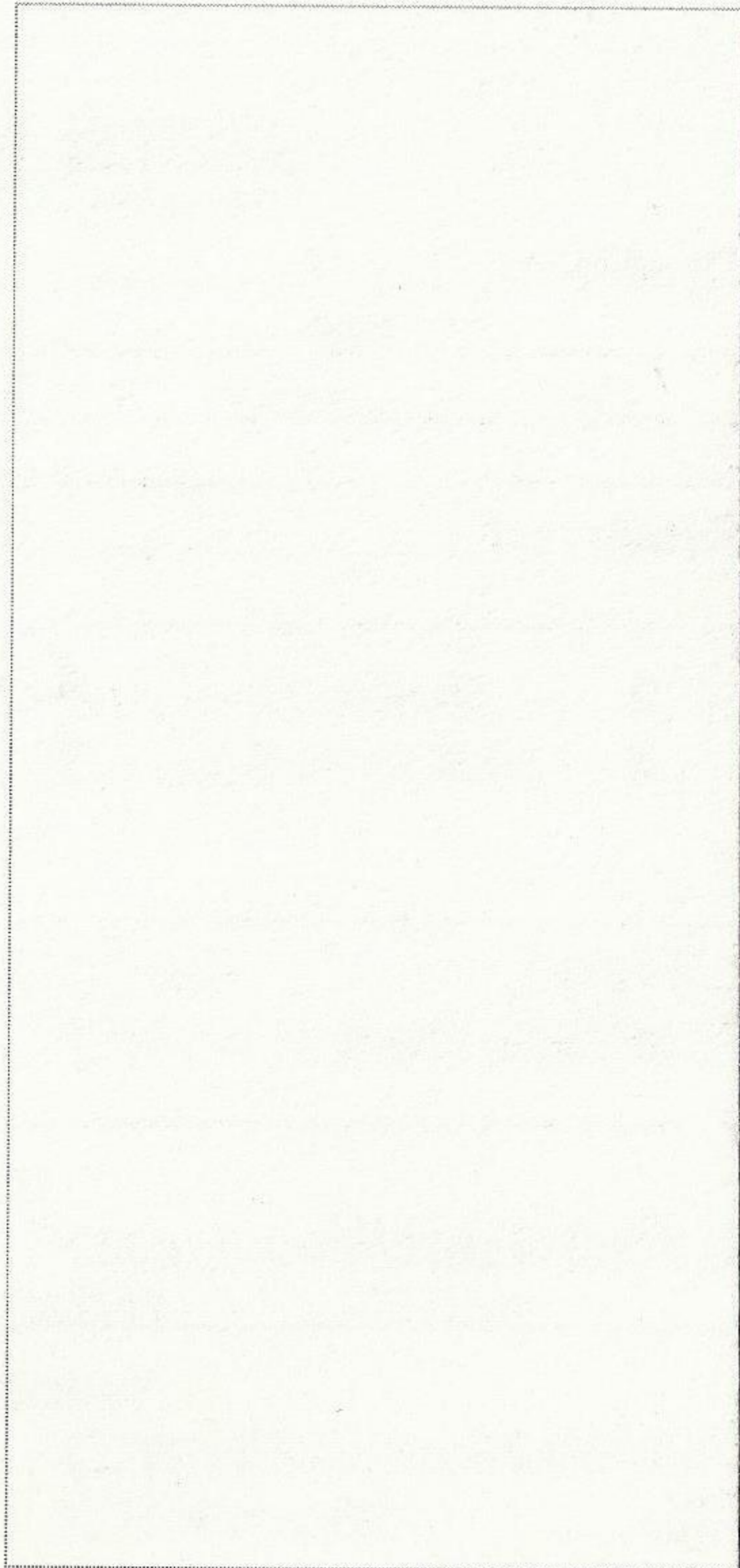

Fish t

Japan, Ameri
These pages
own, don't re

How to E

While you sta
you'll add mo
in the fishing
catch the larg
selective abou
correct lure, r

Japanes

Stocked nearl
Japanese Mo
hone your ang
fish in the gar
fish and acqu

Target Specie

- Yamame
- Rainbow Tro
- Iwana



**PLACE
STAMP
HERE**

NATSUME[®]

Serious Fun[™]

**NATSUME INC.
1818 GILBRETH ROAD, SUITE 229
BURLINGAME, CA 94010**

Japanese River (near source)

The action is fast and furious in this tumultuous river. Because the water is shallow, the Iwana and Amemasu are easily spooked. For best results, cast into the regions where you can see fins breaking the surface, which is usually by the rocks to the left of the rapids.

Target Species:

- Iwana
- Amemasu

To Access:

- Catch four Yamame in the Japanese Mountain Stream.

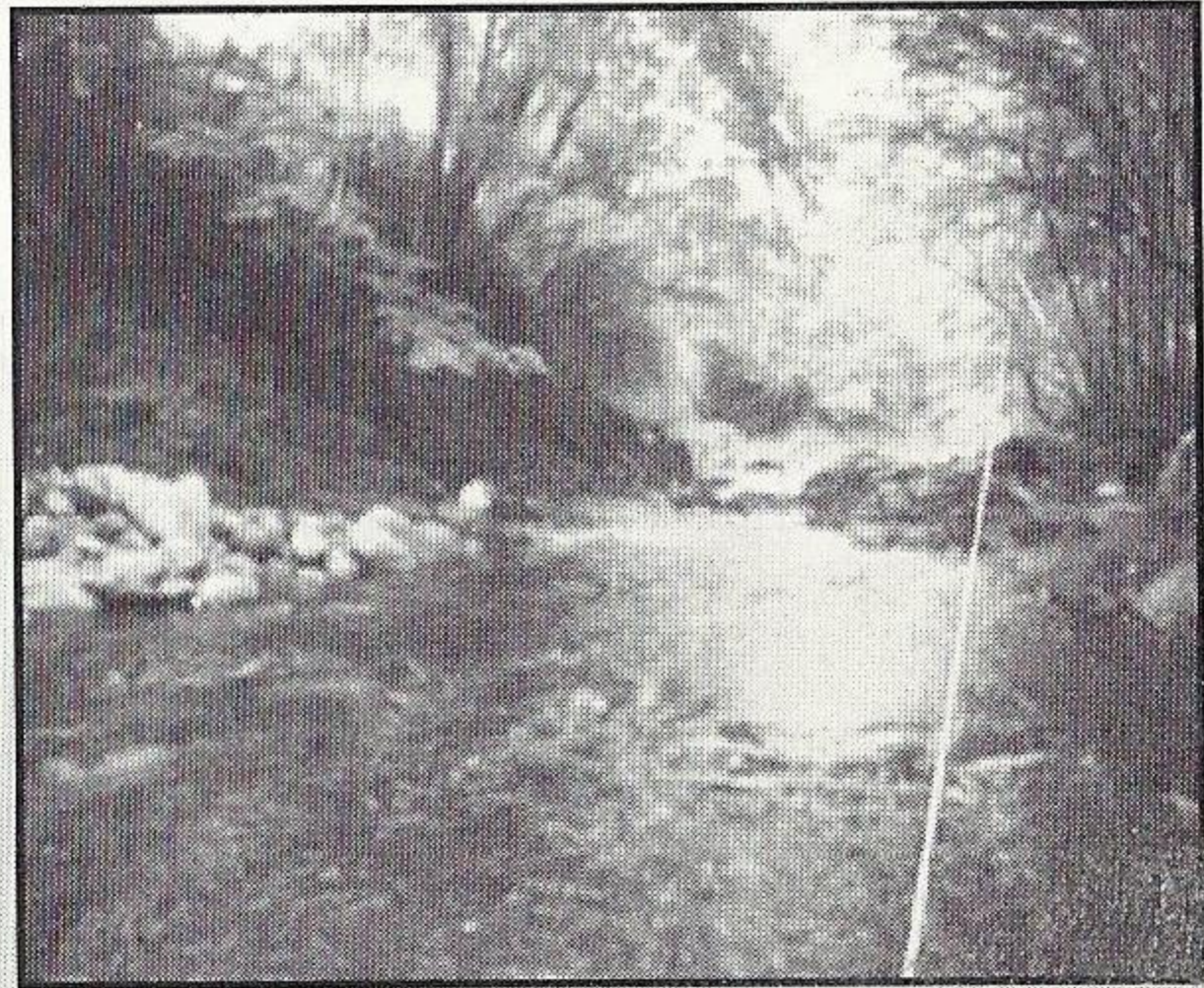

Japanese Mountain Lake

Because this popular lake is stocked with Blue Gill and Rainbow Trout, you're assured plenty of action, but the real trick is landing the eight Black Bass you'll need to move on to the North American Pond in the next stage.

Target Species:

- Black Bass

To Access:

- Catch eight fish in the Japanese River (near source)

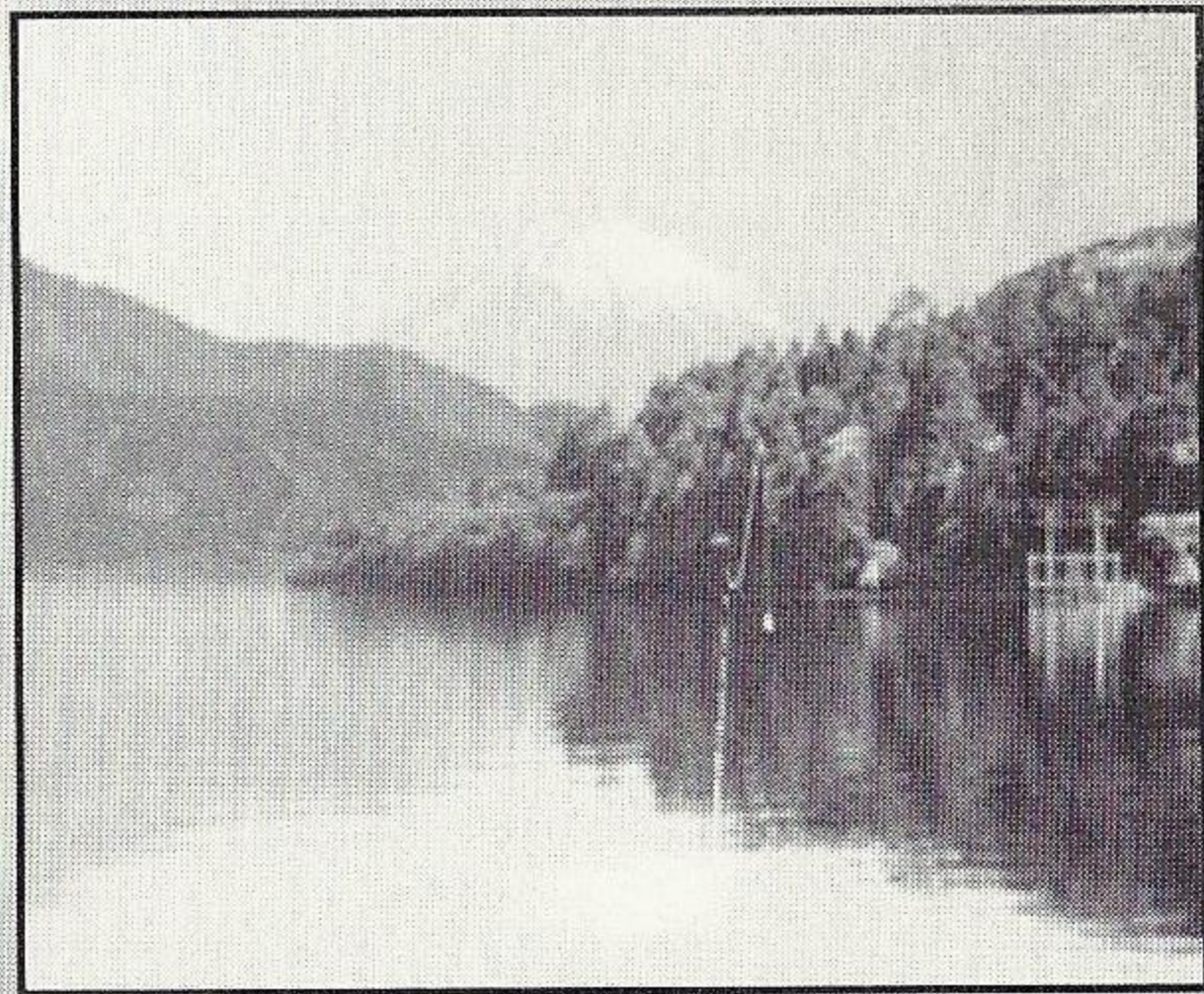

North American Pond

Formed by local river improvement projects, this pond is home to plenty of behemoth Bass, but the challenge is in losing the schools of Blue Gills. Casting accuracy is key here-watch for bass from the underwater lure view, then cast to the areas where you spot the bass.

Target Species:

- Black Bass

To Access:

- Catch eight Black Bass in the Japanese Mountain Lake

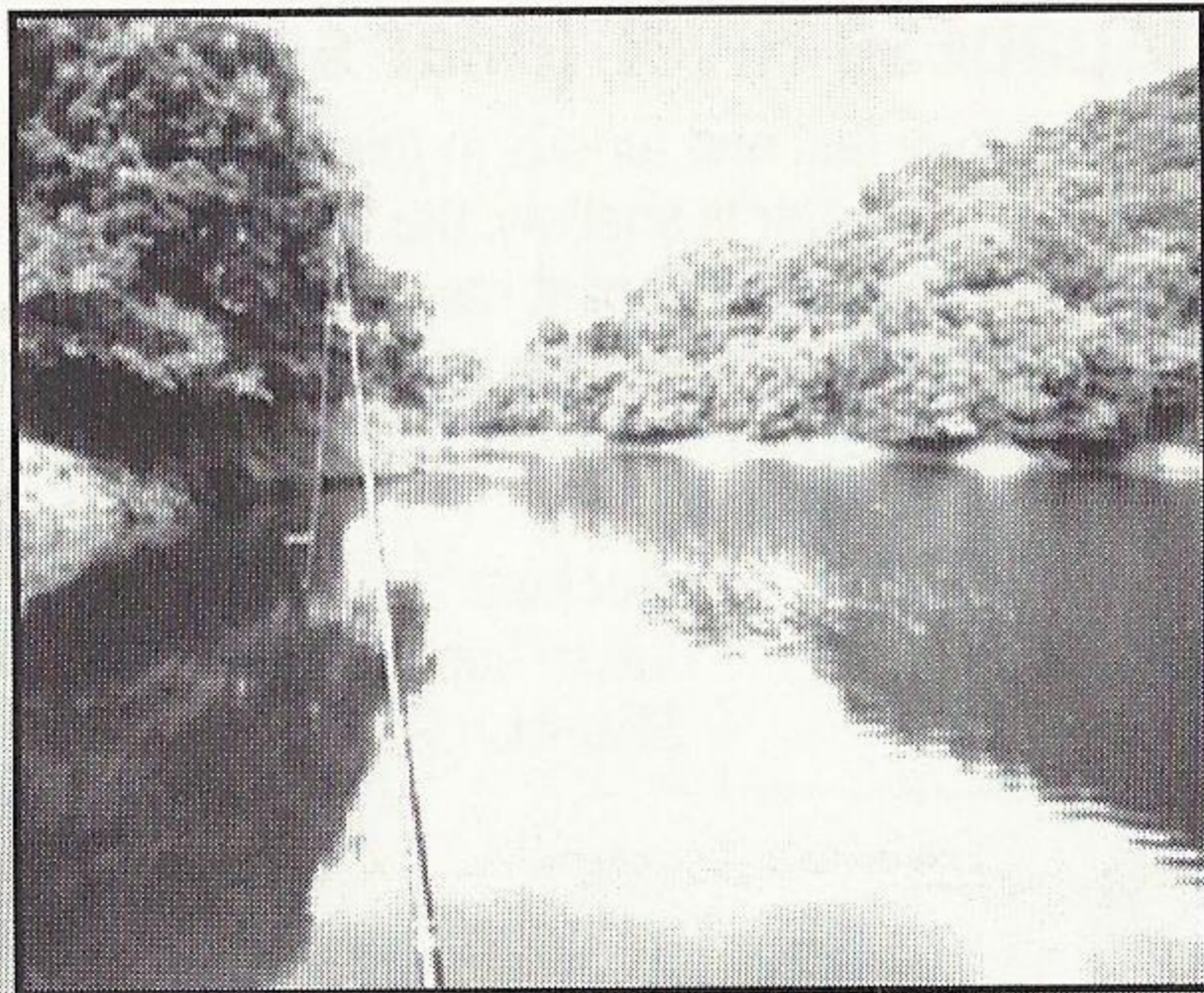

North American Reservoir

Long, accurate casts are essential for landing the monster bass in this reservoir. Patience is a key factor for success here, but you can increase your chances for strikes by monitoring the temperature gauge (B Button). Don't waste your time trolling if the conditions chill.

Target Species:

- Black Bass

To Access:

- Catch a Black Bass over 50 cm. long in the North American Pond

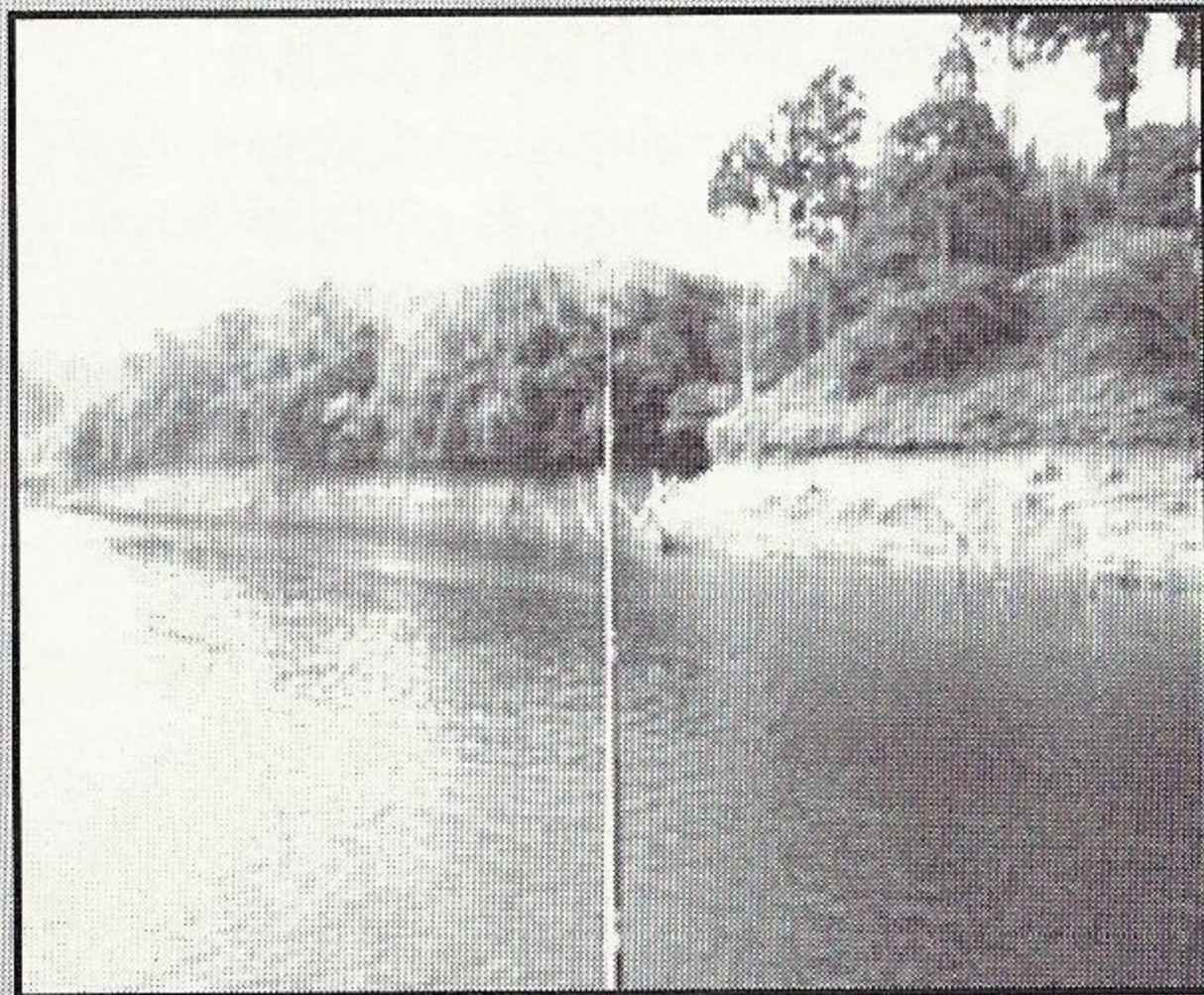

North American River (mountains)

Large and powerful King Salmon gather at this river bend prior to spawning. While casting and lure selection won't be much of an issue, landing Kings requires skill earned through broken lines and lost lures.

Target Species:

- King Salmon

To Access:

- Catch sixteen fish of any species in the North American Pond

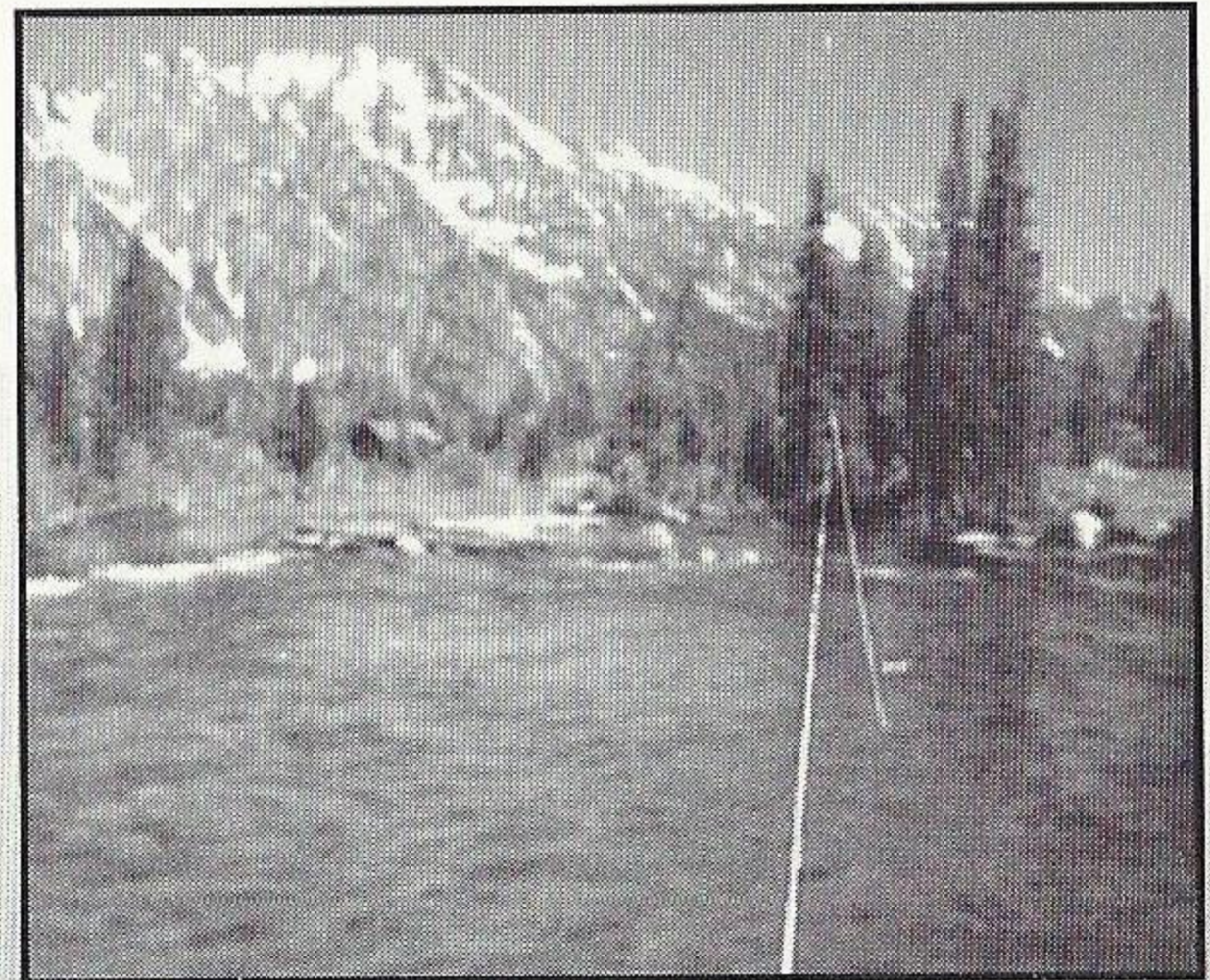

North American Highland River

To protect themselves from airborne predators, Trout seek shady overhangs and other sheltered locations. Keep this in mind when you cast near the bridge pilings on the Highland. It's a great place to find the large Steelhead and Rainbows you need to open the next stage.

Target Species:

- Rainbow Trout
- Steelhead

To Access:

- Catch a King Salmon over 100 cm. in the North American River (mountains)

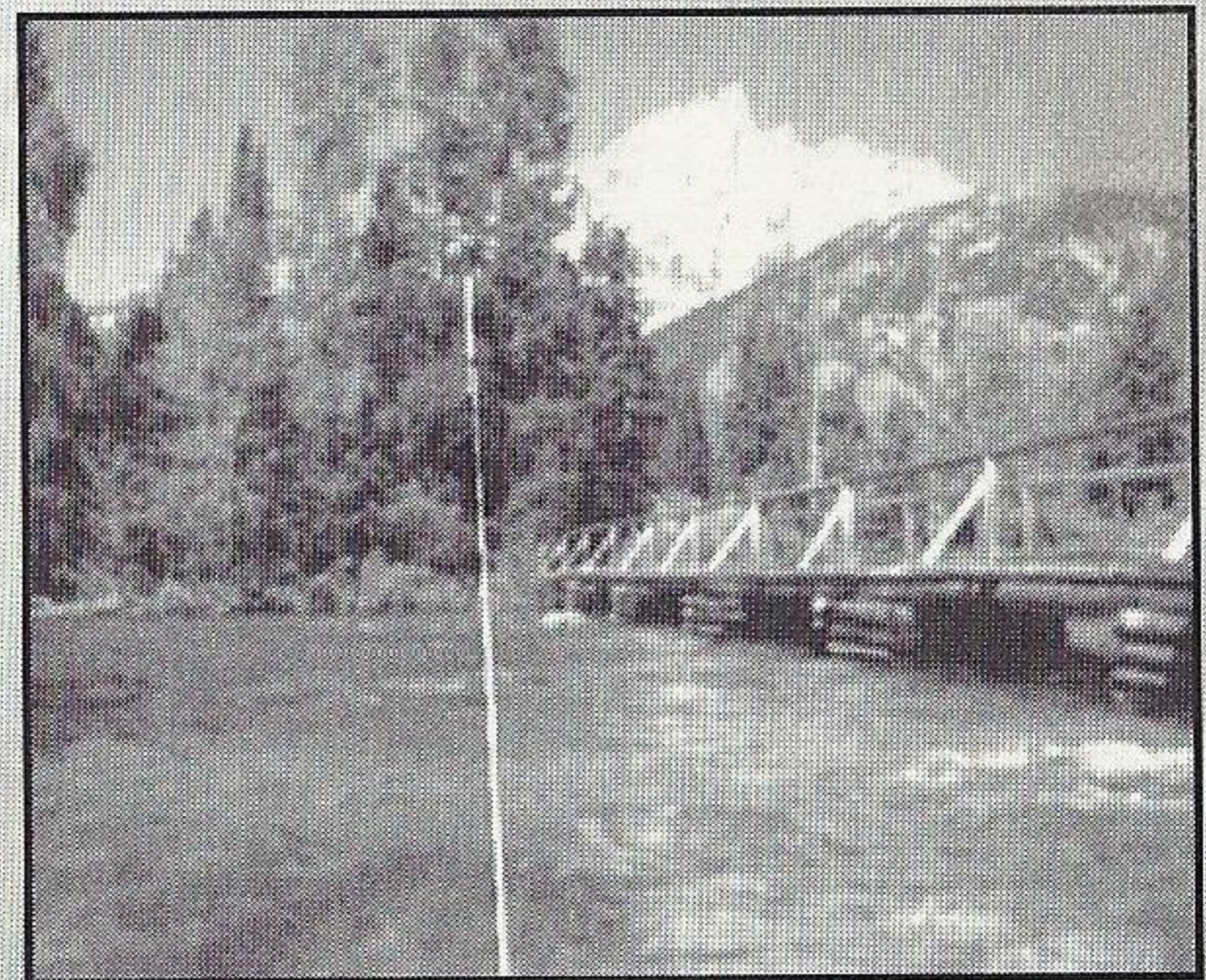

Canadian Lake

Canada is home to some of the clearest and most pristine lakes in the world. If you've been reading your lure descriptions, you'll probably guess that your minnows are an excellent choice for Pike. Just remember to use your heavy pound test line-you're in for a brawl.

Target Species:

- Northern Pike

To Access:

- Catch a Steelhead over 100 cm. in North American Highland River

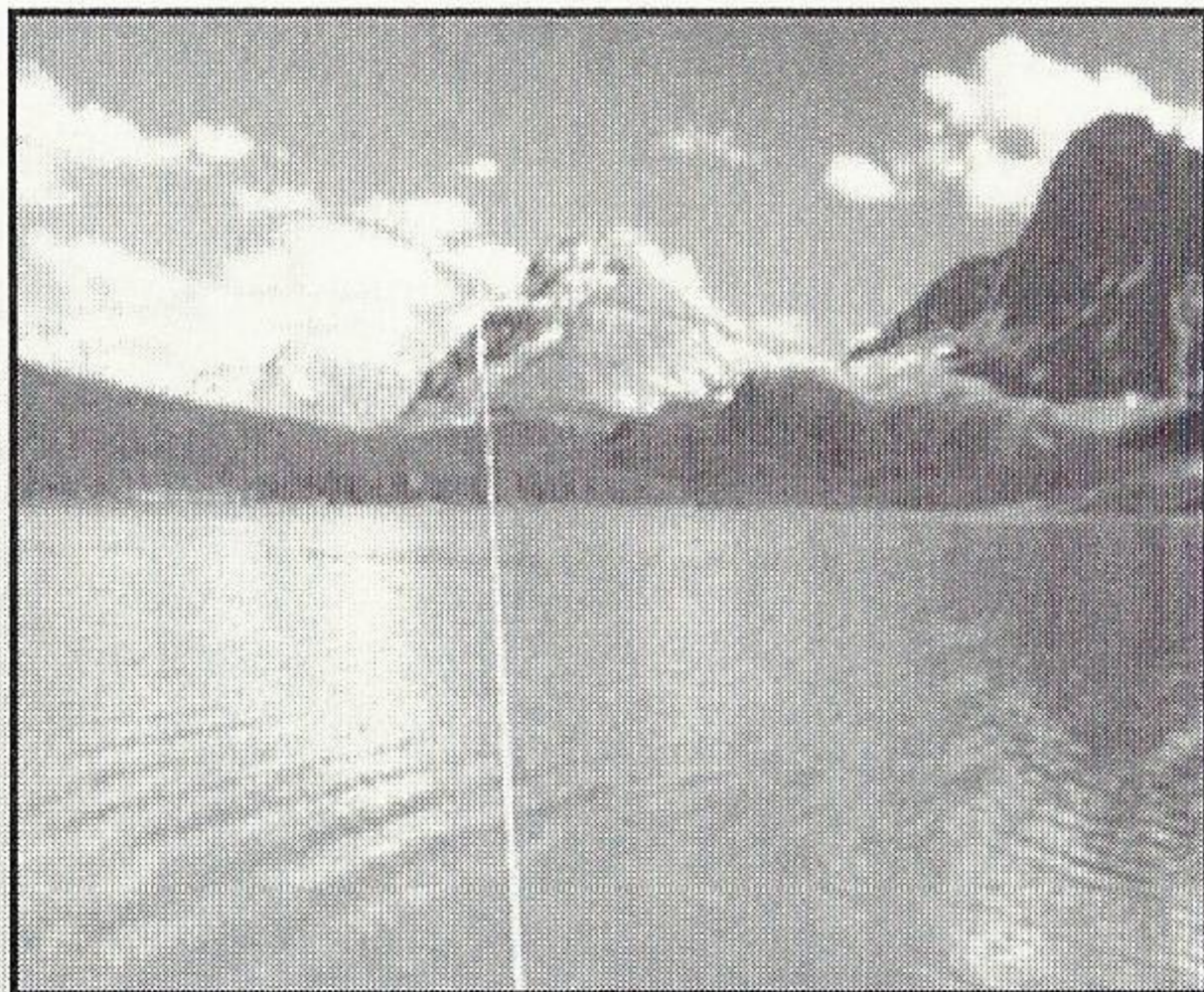

Australian River

Experienced anglers know the importance of observation, especially when it comes to determining what the fish are eating. You might not see any food sources in this Australian River, but listen closely and you'll quickly identify one of the Barramunda's favorite meals.

Target Species:

- Barramunda

To Access:

- Catch four Northern Pike in the Canadian Lake

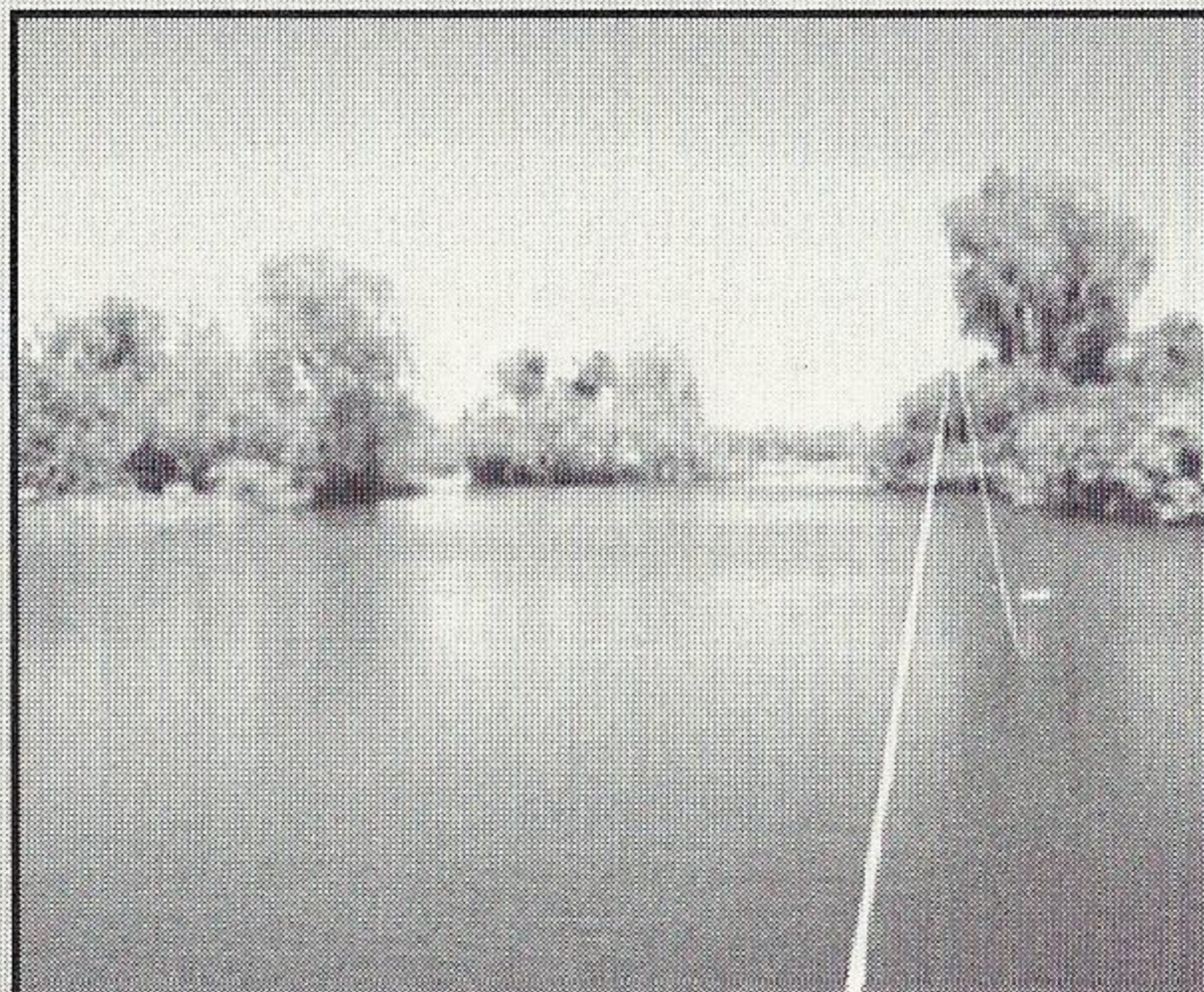

New Zealand River 1

The thick weeds growing along the bottom of the Tongariro River on New Zealand's North Island are home to large Browns and Rainbows, as well as schools of tiny fry. Keep in mind that you can save time by intentionally breaking off a line attached to unwanted small Trout.

Target Species:

- Brown Trout
- Rainbow Trout

To Access:

- Catch eight King Salmon in the North American River (mountains)

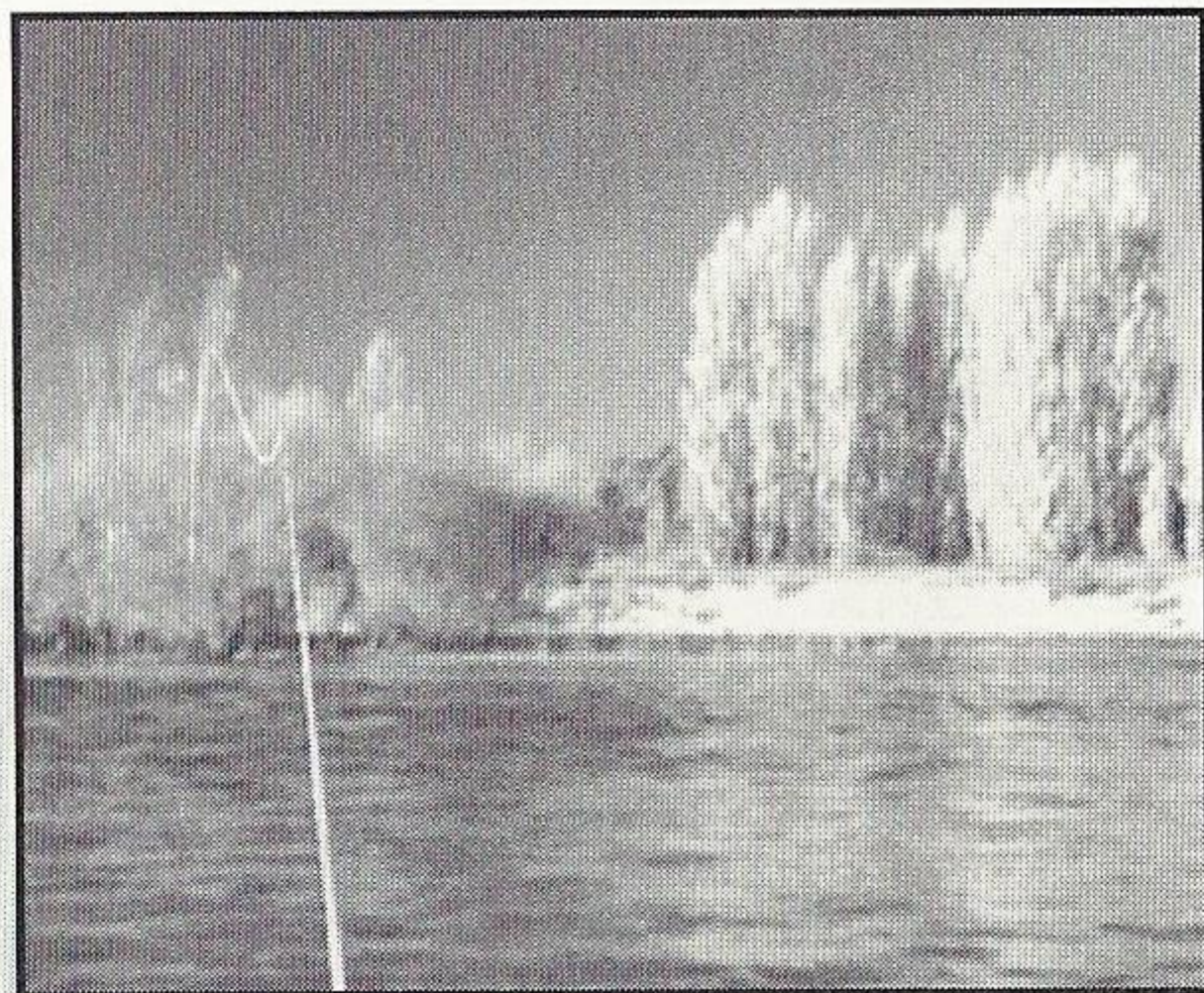

New Zealand River 2

Hidden among the riffles of this river bend are monster Browns and Rainbows. Their diet consists largely of terrestrials-insects and rodents that fall off brush and into the water. With this in mind, select lures that mimic insect behavior and cast just below the rapids.

Target Species:

- Brown Trout
- Rainbow Trout

To Access:

- Catch a Rainbow Trout or Brown Trout over 60 cm. at New Zealand River 1

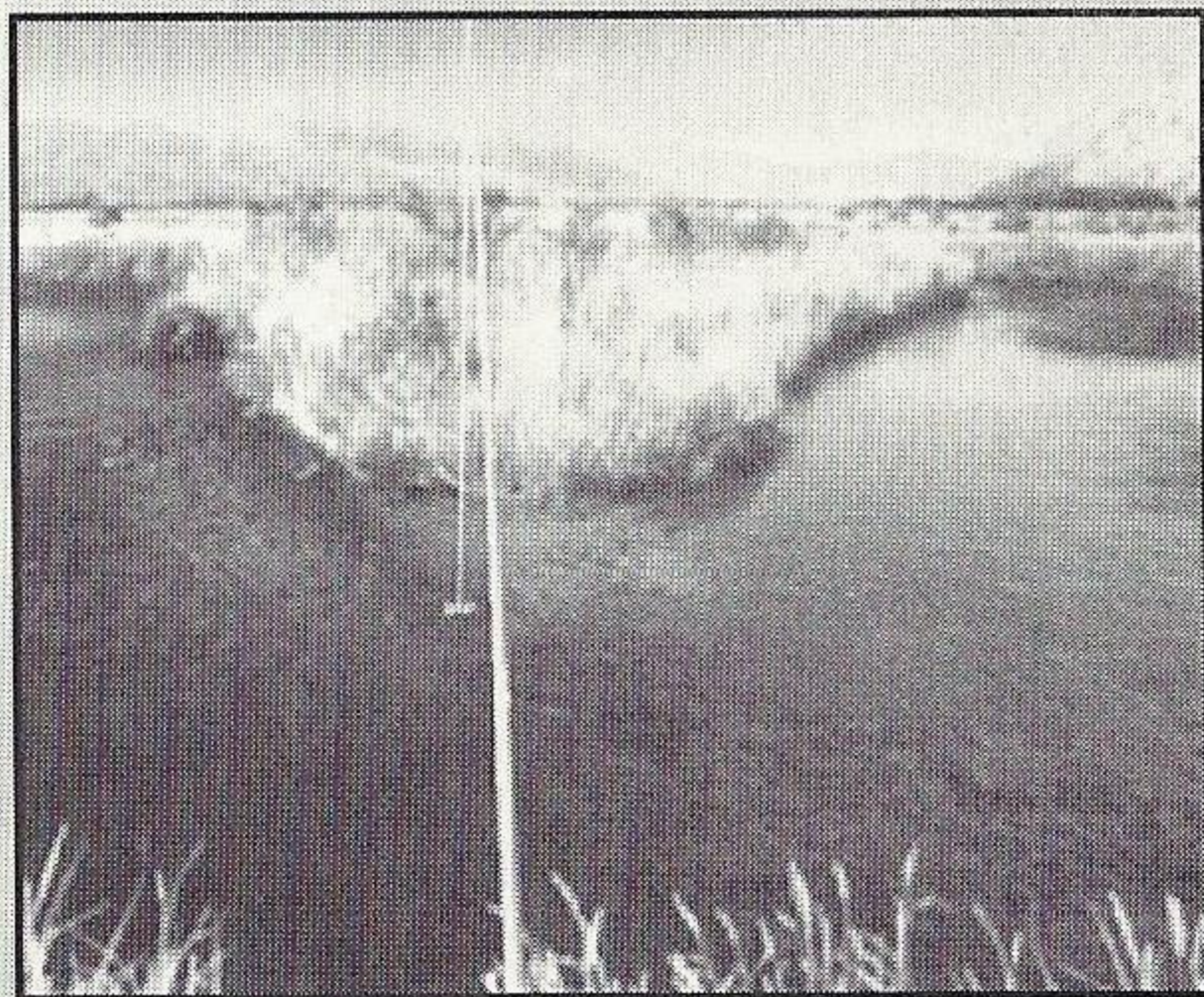

The Amazon (branch river)

The Amazon is home to some of the largest freshwater fish in the world, including the famous Pirarucu. While the Pirarucu might be large, it has the same natural instincts as smaller freshwater fish in the world-it prefers to seek cover among the roots of aquatic plants.

Target Species:

- Pirarucu

To Access:

- Catch a Barramunda over 50 cm. in the Australian River
- Catch a Rainbow Trout or Brown Trout over 70 cm. in New Zealand River 2

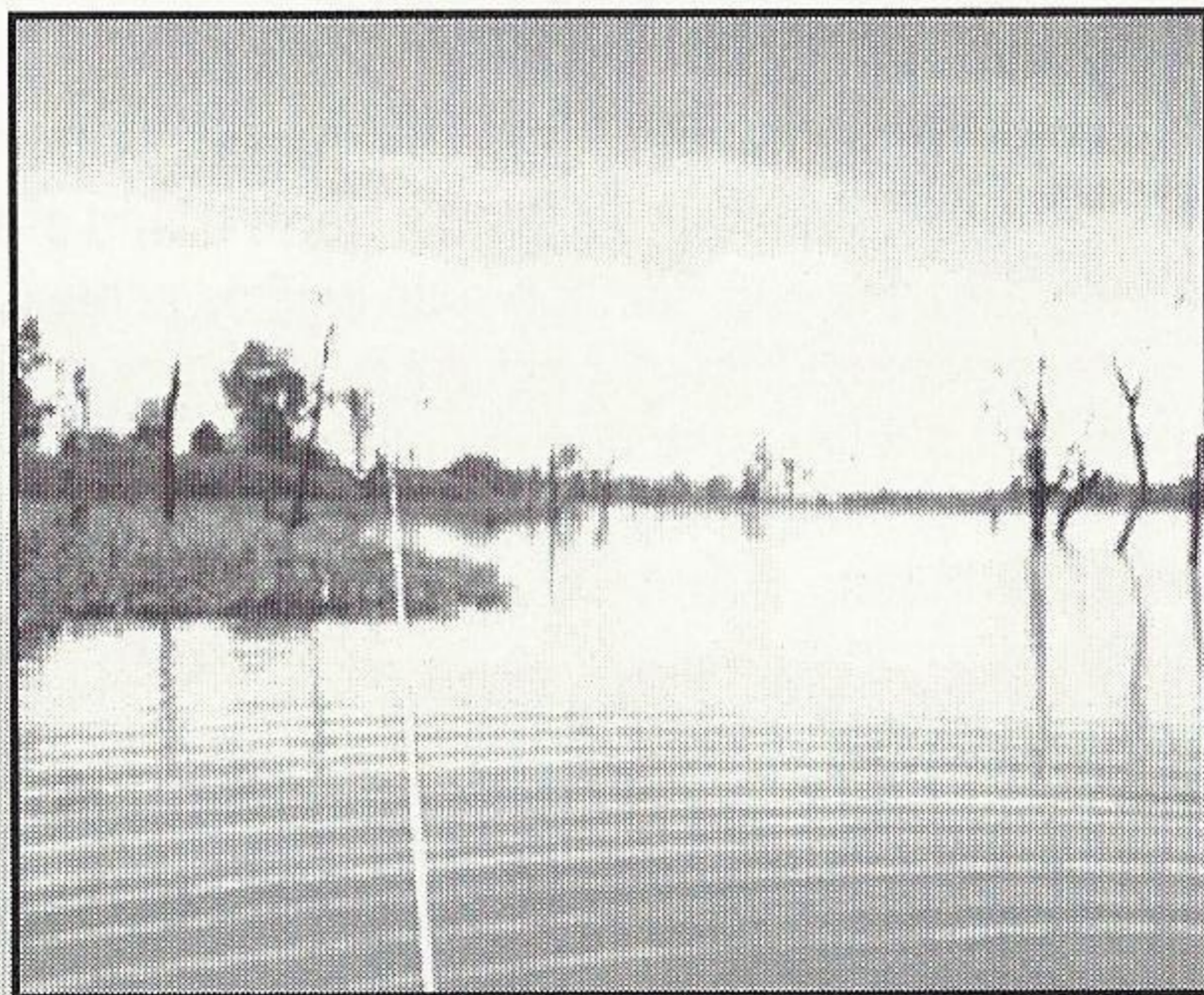

Middle Amazon

Don't let the placid waters of this slow-flowing river fool you. Beneath the calm surface are dozens of hungry Black Piranhas and Piranha Mattereri. To find Peacock Bass, try casting into the hidden shallows. You'll have to hook a few Piranhas before you locate the shoals.

Target Species:

- Peacock Bass

To Access :

- Catch a Black Bass over 70 cm. in the North American Pond
- Catch a Steelhead over 120 cm. in North American Highland River
- Catch a Pirarucu in The Amazon (branch river)

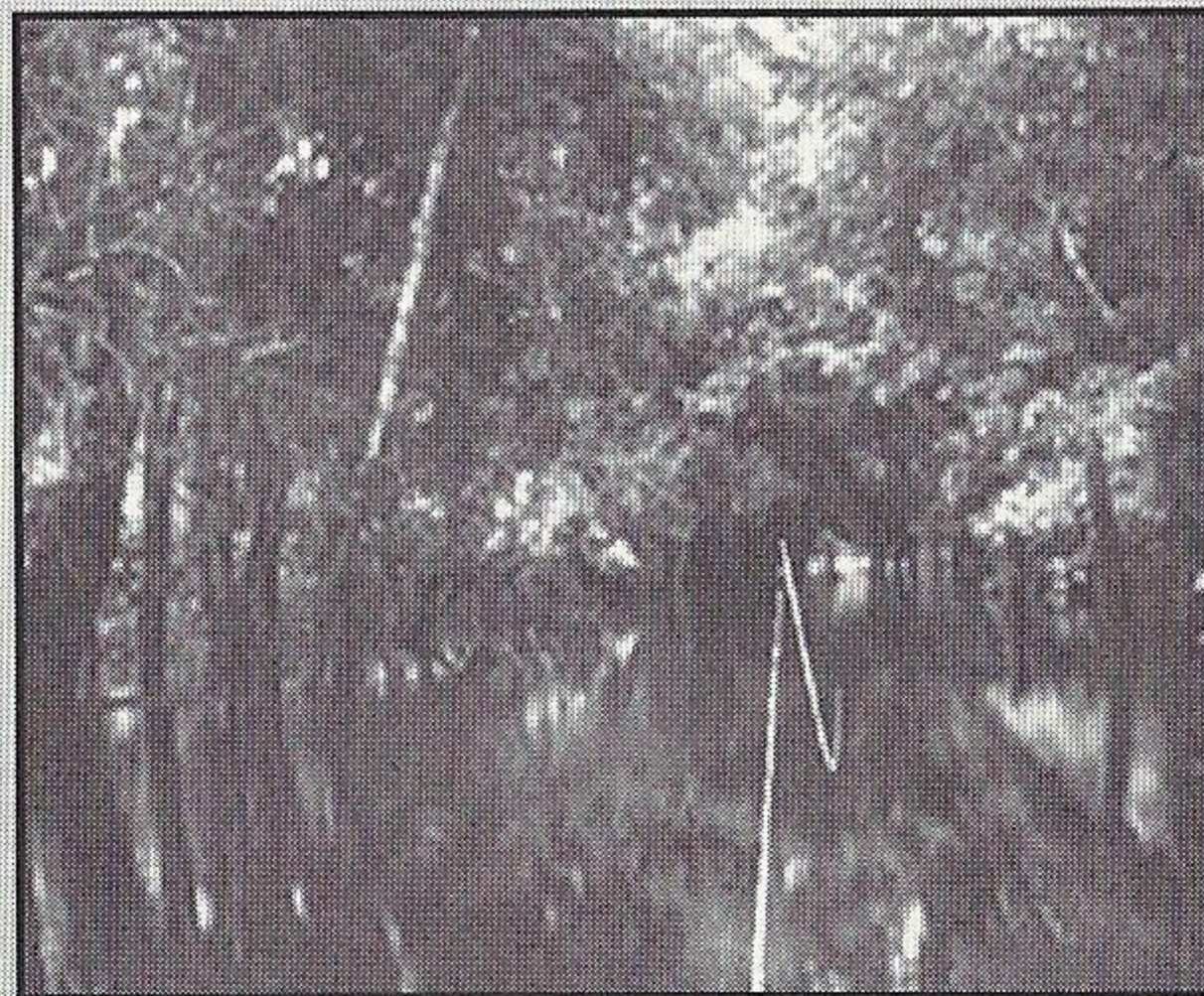

Pantanal, South America

The rare Golden Dorado is native to Pantanal and one of South America's top game fish. This reclusive predator cruises along the shoreline in search of smaller fish, so your best chance of catching one is casting into the many schools of Piranhas and Payaras along the shore.

Target Species:

- Golden Dorado

To Access:

- Catch any eight fish in Japanese River (near source)
- Catch eight Peacock Bass in the Middle Amazon

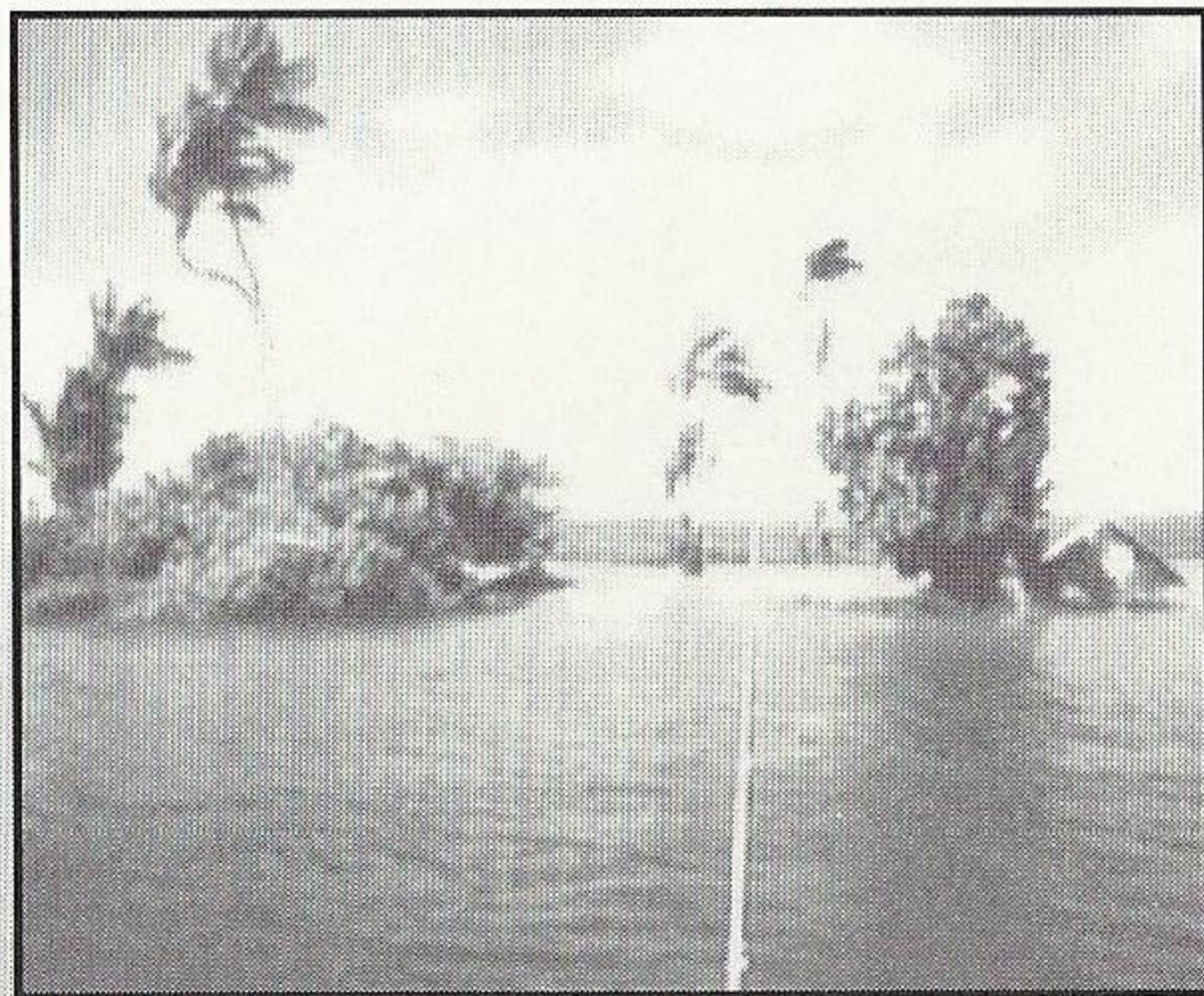

So you've opened all the rivers and now you think you have it all? Think again-have you caught one of every fish in your fishing notebook? How big are your catches for every species? Start fishing!



Tips for Catching Fish

Even after you know how to check the climate conditions and change tackle, catching big fish in Reel Fishing® I Wild won't happen overnight, but following these tips will certainly speed up your progress.

Look Before You Cast

Study the water surface and you'll spot small disturbances: A dorsal fin here, sunlight reflecting off silver scales there. These are the areas where the fish are feeding. This is where you need to cast.

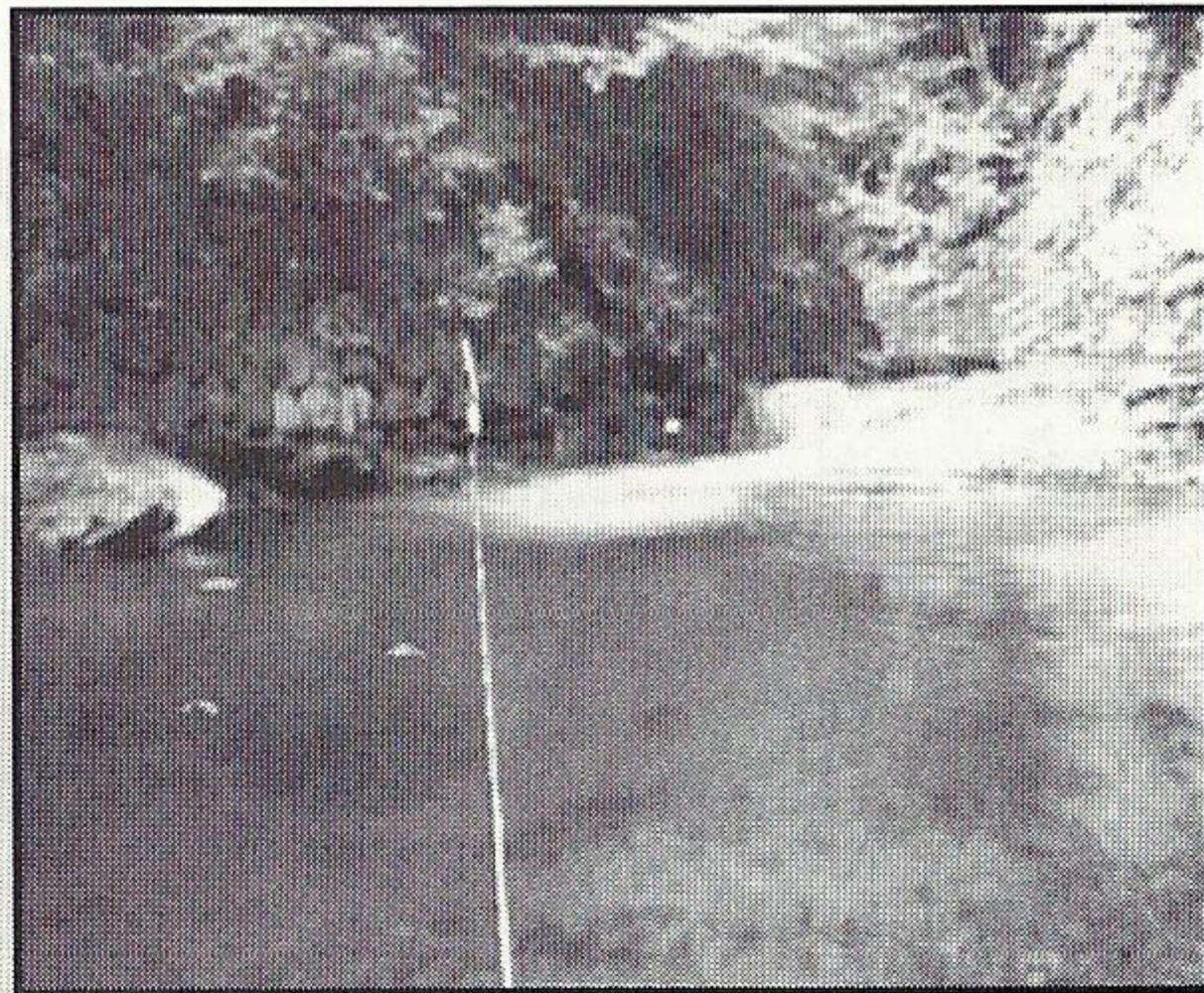

Casting

To aim your rod prior to casting, push the Analog Thumb Pad or press the D-Button. If you're using a standard controller, press the A Button to cast. The longer you hold the A Button, the further your lure will travel based on rod power. To cast with the fishing controller, cast as you would with a normal fishing rod (quickly tilt the fishing controller forward). The velocity of your arc will determine the casting distance.

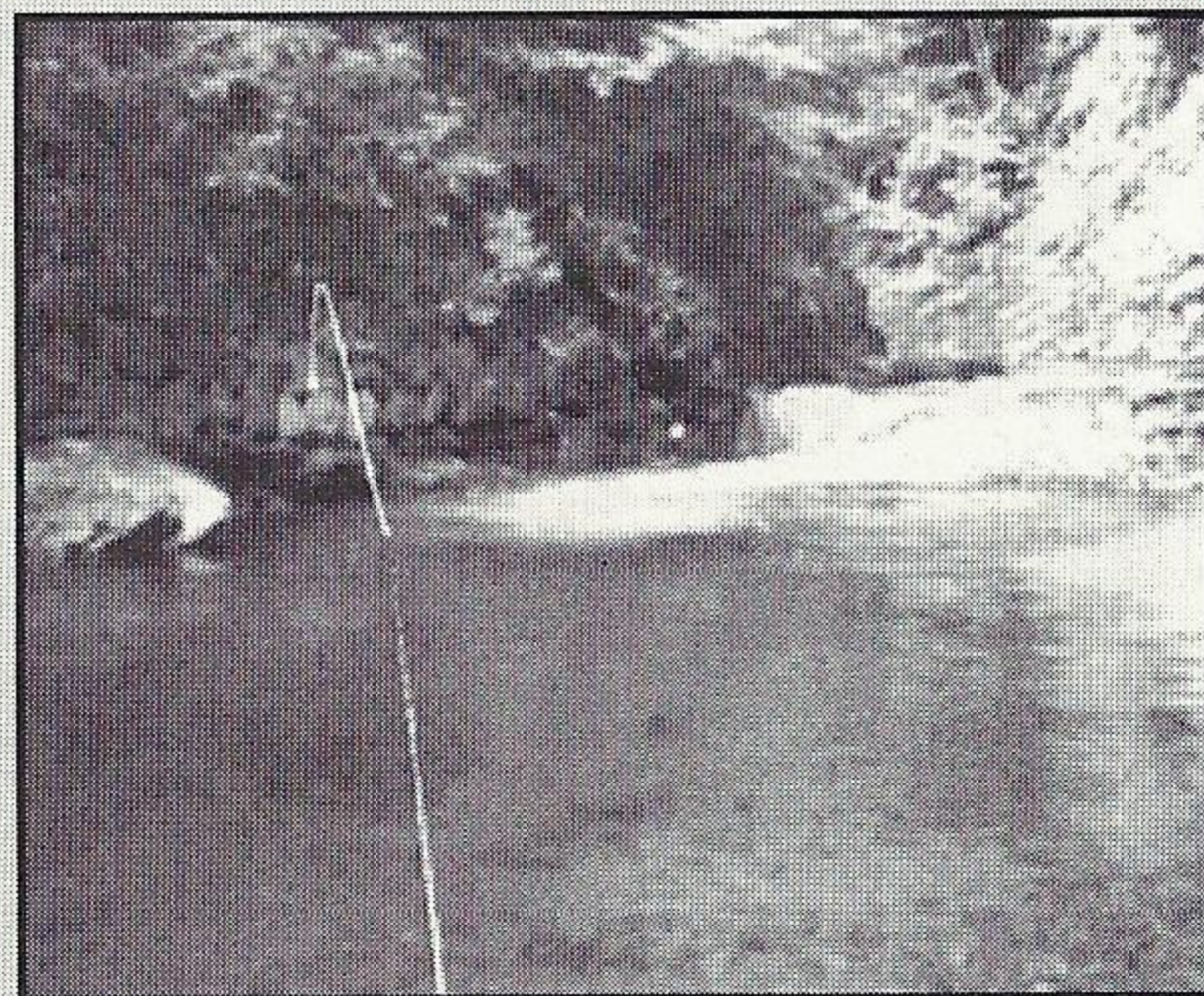

Be the Bait

If your lure is in the vicinity of a fish, the view will change to an underwater perspective. Successful fishing isn't about thinking like a fish—it's about thinking like bait. Your lure must resemble food to attract fish, which is why the speed at which you retrieve (press the Trigger R or reel) the lure often determines whether a fish will strike. Keep in mind that if you're prey, you want to swim away. A steady or fast retrieve is usually all the convincing a hungry fish needs to strike.



Set the Hook

As in real angling, setting a hook is an intuitive timing skill attained with experience. To set the hook with a standard controller, press the A Button as the fish strikes (you can also move the Analog Thumb Pad to one side). To set the hook with the fishing controller, tug upward as the fish strikes. You'll probably lose several fish, but you'll eventually acquire the timing.

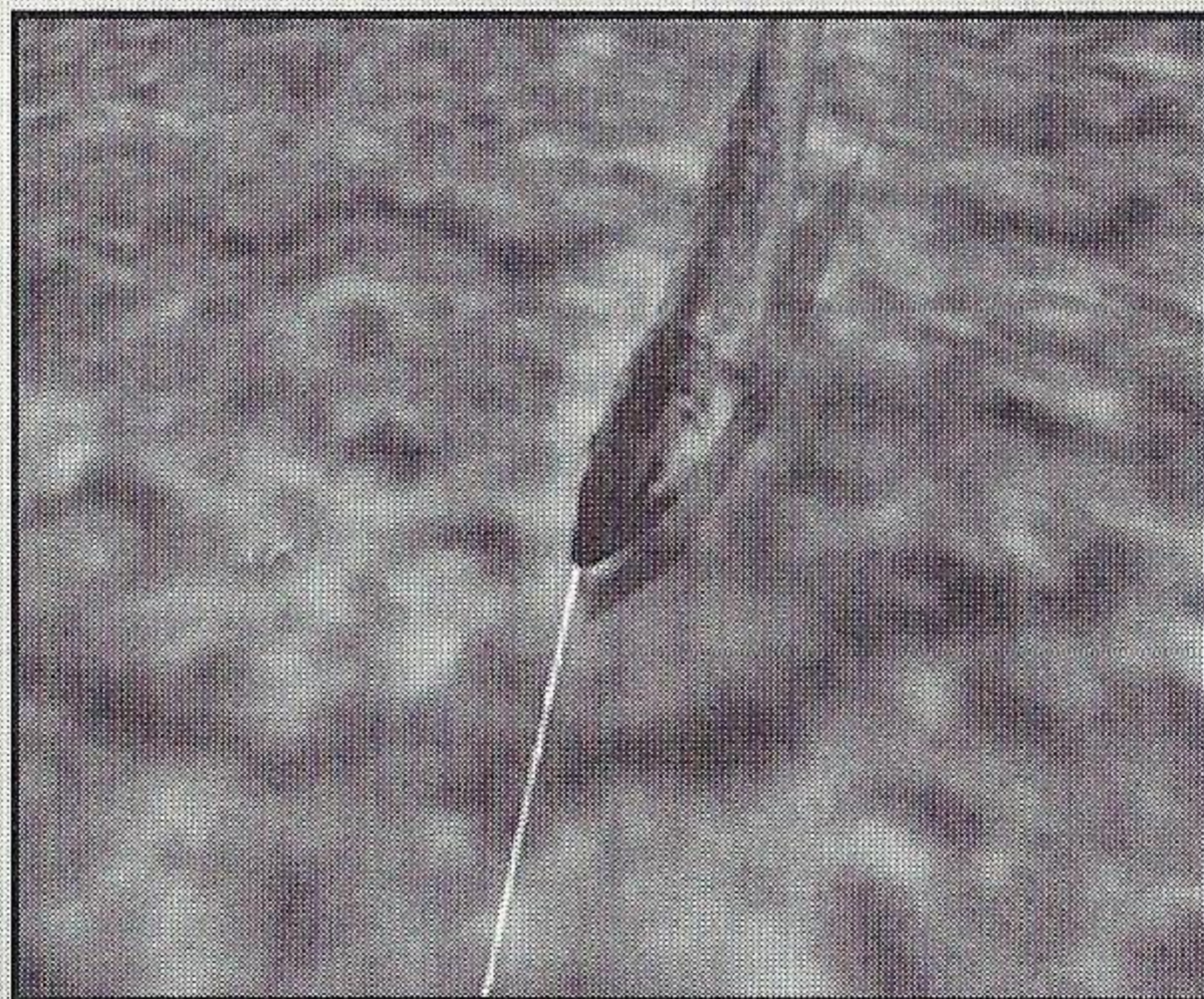

Playing A Fish

You've cast to the fish, you set the hook, now the fun begins-playing the fish involves reeling line in whenever the fish pauses to rest or swims in your direction. Landing the fish depends on knowing the limits of your tackle, especially your line weight and when to retrieve line. Even relatively strong line will quickly snap if you reel too hard or too fast while a fish is struggling against you. If you have the jump pack or the fishing controller, the vibration intensity will eliminate the guesswork out of measuring line tension. If you don't have these peripherals, listen for the line splashing in the water. Unless you're using a line with the strength of piano wire, stop reeling your fish whenever you feel strong vibrations or hear splashes. Continue taking up the slack when the fish rests or starts to swim toward your location. The line will appear near vertical when the fish is close to your location. When the fish is exhausted or nearby, you'll automatically land the fish.

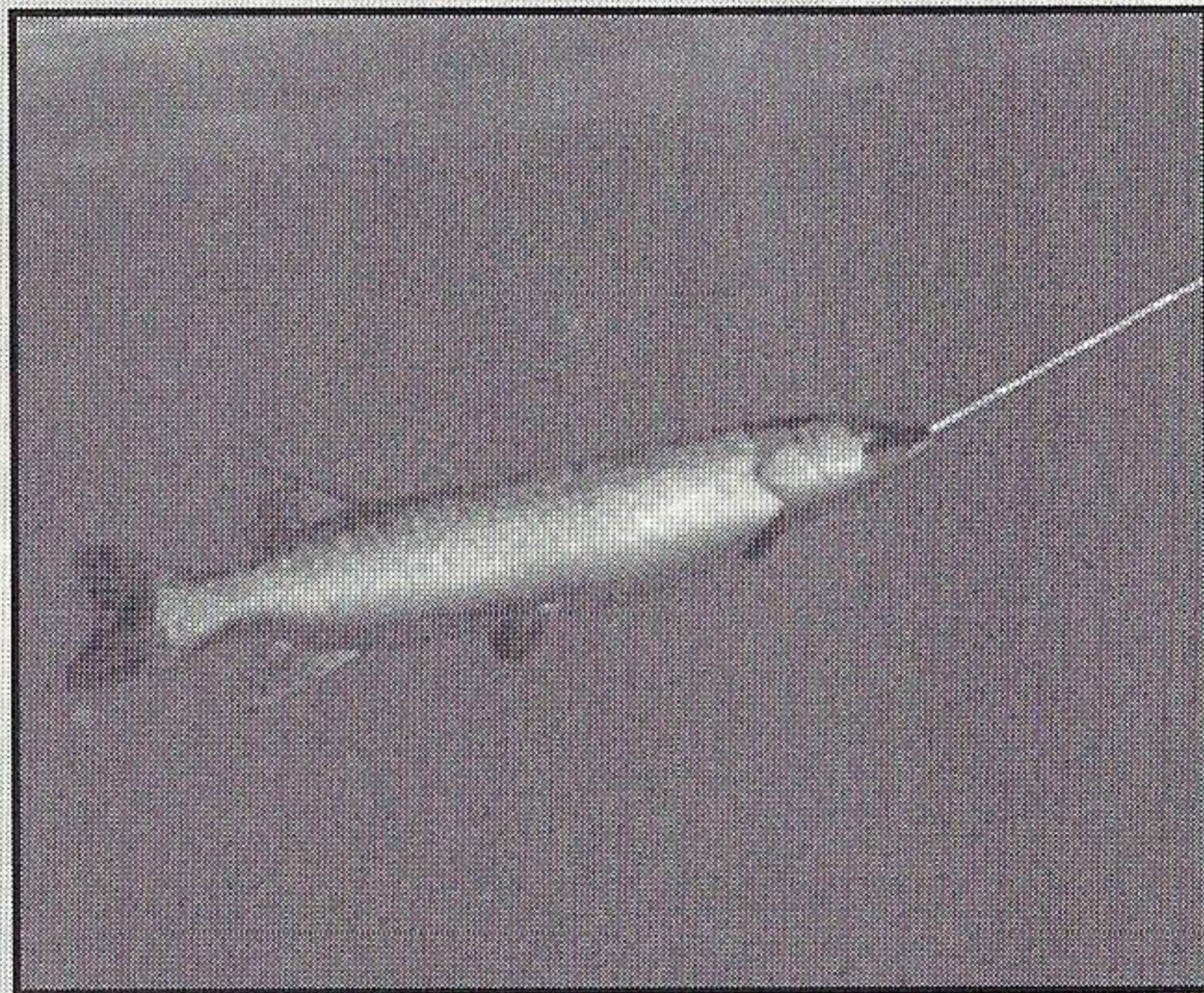
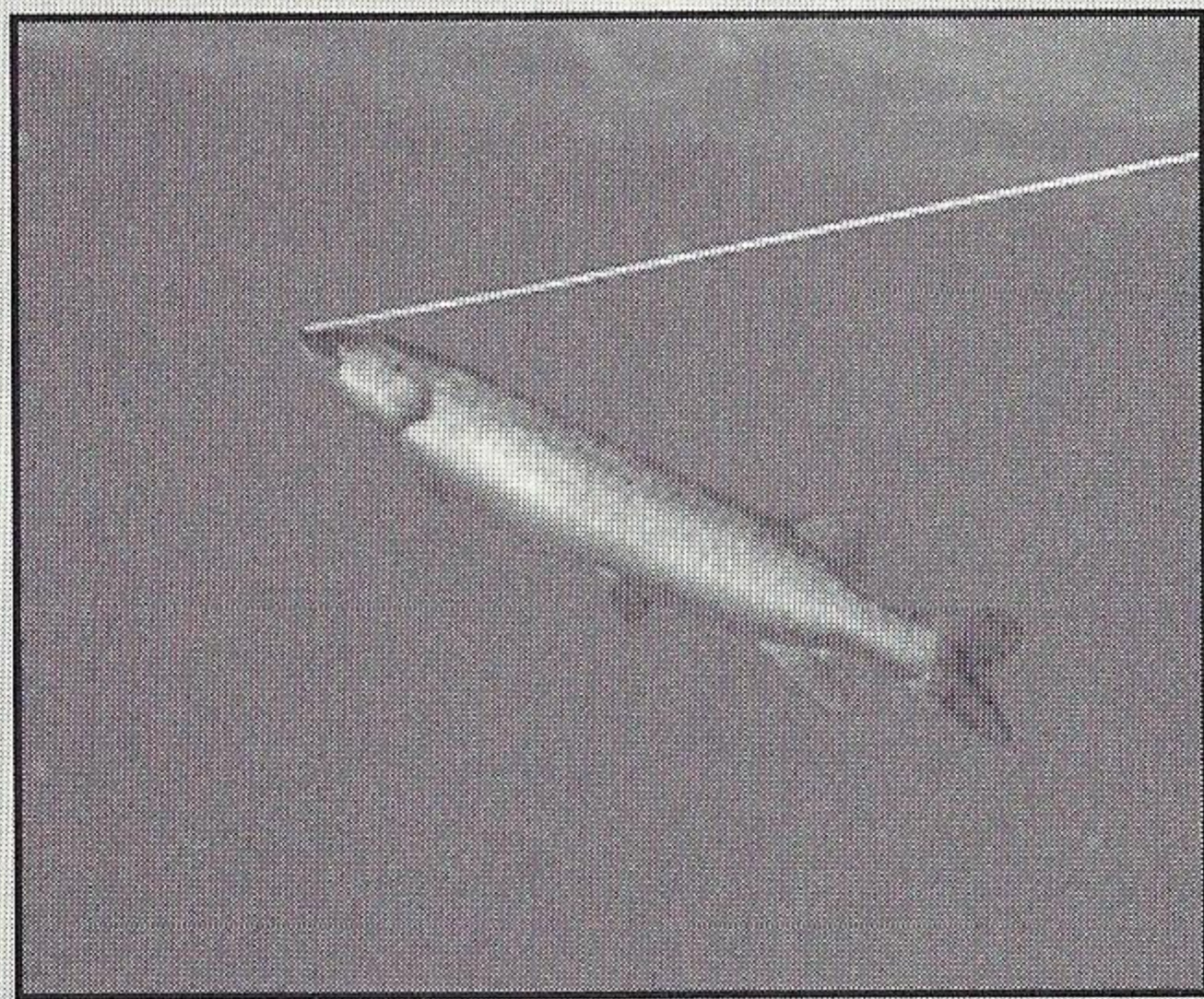

Rod Action

One method for tiring the fish is to lean your rod in the opposite direction that the fish is swimming. This is accomplished by pushing the Analog Thumb Pad or pressing the D-Button as the fish swims away. Watch your line tension while applying pressure or you may end up watching the fish escape with your lure and your broken line.

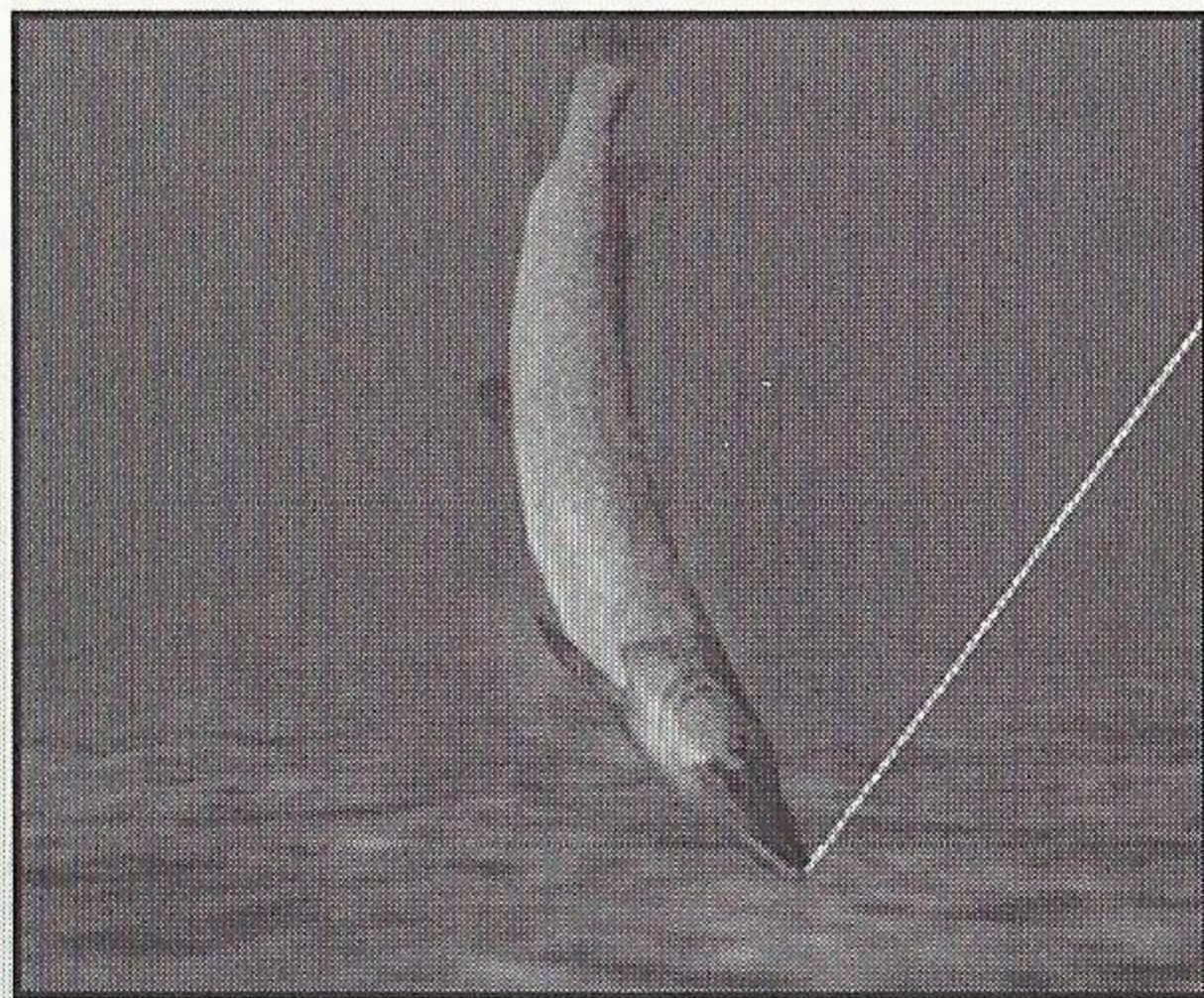

Landing a Fish

You'll automatically land the fish when the fish stops fighting or reaches your location. The screen will fade to white and then you'll see a lifelike display of your latest catch with the official length in the lower right corner of the screen. If the fish is too big for a normal view, push the Analog Thumb Pad or press the D-Button to examine your catch from upturned mouth to tapered tail.

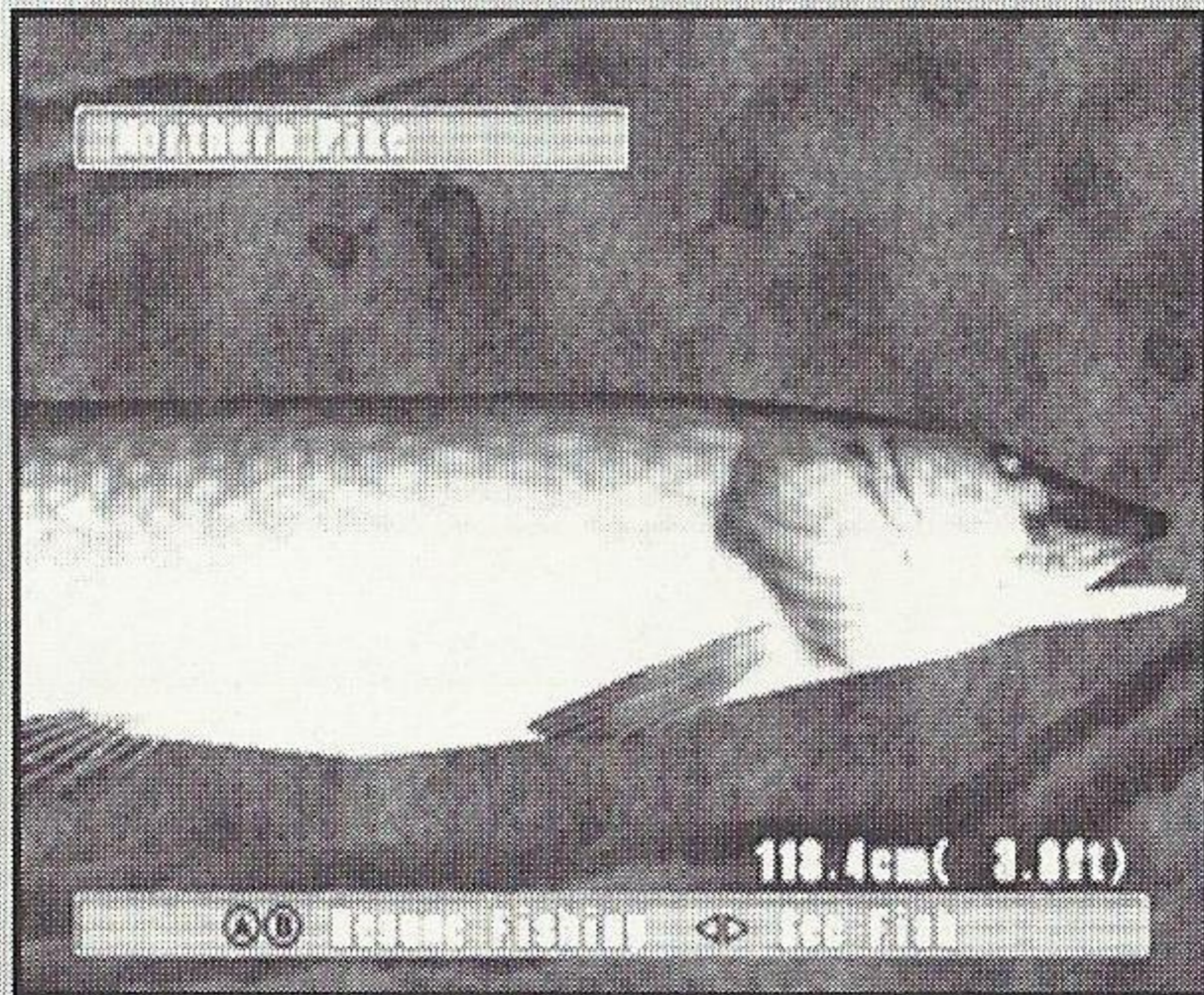

Limited Warranty

Natsume Inc. warrants to the original purchaser of this Natsume product that this Sega Dreamcast Specific GD-ROM is free from defects in materials and workmanship for a period of ninety (90) days from the date of purchase. This Natsume product is sold "as is" without expressed or implied warranty of any kind, and Natsume is not liable for any losses or damages of any kind resulting from the use of this product. If a defect covered by this warranty occurs during this 90-day warranty period, Natsume will repair or replace the Sega Dreamcast Specific GD-ROM, at its option, free of charge. Send product postage paid, along with the dated proof of purchase, to the address shown below. This warranty shall not be applicable and shall be void if the defect in the Natsume product arises through abuse, unreasonable use, mistreatment or neglect.

THIS WARRANTY IS IN LIEU OF ALL OTHER WARRANTIES AND NO OTHER REPRESENTATIONS OR CLAIMS OF ANY NATURE SHALL BE BINDING ON OR OBLIGATE NATSUME. ANY IMPLIED WARRANTIES APPLICABLE TO THIS PRODUCT, INCLUDING WARRANTIES OF MERCHANTABILITY AND FITNESS FOR A PARTICULAR PURPOSE, ARE LIMITED TO THE NINETY (90) DAY PERIOD DESCRIBED ABOVE. IN NO EVENT WILL NATSUME BE LIABLE FOR ANY SPECIAL, INCIDENTAL OR CONSEQUENTIAL DAMAGES RESULTING FROM POSSESSION, USE OR MALFUNCTION OF THIS PRODUCT.

Some states do not allow limitations as to how long an implied warranty lasts and/or exclusions of limitations of incidental or consequential damages, so the above limitations and/or exclusions of liability may not apply to you. This warranty gives you specific rights, and you may also have other rights which vary from state to state.



NATSUME INC.
1818 GILBRETH ROAD, SUITE 229
BURLINGAME, CA 94010
Phone: (650) 692-1941

Please be sure to visit our homepage at: www.natsume.com

ESRB RATING

This product has been rated by the Entertainment Software Rating Board. For information about the ESRB rating, or to comment about the appropriateness of the rating, please contact the ESRB at 1-800-771-3772.

Sega is registered in the US Patent and Trademark Office. Sega, Dreamcast and the Dreamcast logo are either registered trademarks or trademarks of Sega Corporation. All Rights Reserved. Made and printed in the USA. WARNING: Operates only with NTSC televisions and Sega Dreamcast systems purchased in North and South America (except Argentina, Paraguay and Uruguay). Will not operate with any other televisions or Sega Dreamcast systems. Product covered under one or more of the following U.S. Patents: 5,460,374; 5,525,770; 5,627,895; 5,688,173; 4,442,486; 4,454,594; 4,462,076; Re. 35,839; Japanese Patent No.2870538, (Patents pending in U.S. and other countries); Canada Patent No. 1,183,276. The ratings icon is a trademark of the Interactive Digital Software Association. Sega of America Dreamcast, Inc., P.O. Box 7639, San Francisco, CA 94120.

The SEGA logo, featuring the word "SEGA" in a bold, stylized, blocky font with a registered trademark symbol (®) to the upper right.

NATSUME[®]

Victor
Interactive Software

Serious Fun[™]

Natsume Inc., 1818 Gilbreth Road, Suite 229, Burlingame, CA. 94010 - Reel Fishing and Natsume are Registered Trademarks of Natsume, Inc. Serious Fun is a Trademark of Natsume, Inc. ©2001 Natsume, Inc. All Rights Reserved. ©2001 Victor Interactive Software

www.natsume.com

Sega is registered in the US Patent and Trademark Office. Sega, Dreamcast and the Dreamcast logo are either registered trademarks or trademarks of Sega Corporation. All Rights Reserved. Made and printed in the USA.
WARNING: Operates only with NTSC televisions and Sega Dreamcast systems purchased in North and South America (except Argentina, Paraguay and Uruguay). Will not operate with any other televisions or Sega Dreamcast systems.
Product covered under one or more of the following U.S. Patents: 5,460,374; 5,525,770; 5,627,895; 5,688,173; 4,442,486; 4,454,594; 4,462,076; Re. 35,839; Japanese Patent No.2870538. (Patents pending in U.S. and other countries); Canada Patent No. 1,183,276. The ratings icon is a trademark of the Interactive Digital Software Association. Sega of America Dreamcast, Inc., P.O. Box 7639, San Francisco, CA 94120.

SEGA[®]