

32X
INTRODUCTION
and
SYSTEM FEATURES

4/26/94

Rex Sabio
242

© 1994 SEGA. All Rights Reserved.

Introduction

Genesis Super 32X (32X) is a "2 X 32 bit" hardware upgrade that will provide arcade-quality game experiences from existing 16-bit Genesis hardware.

When attached to the Sega Genesis or Sega CD, the 32X will incorporate some of the game play capabilities to be found on the upcoming "Saturn" system.

The 32X will use the Hitachi SH2 RISC chips destined for Saturn. The two SH2 chips in the 32X will complement a newly-designed VDP (video digital processor) chip to bring to the Genesis faster processing speed, high color definition, texture mapping, improved computer polygon graphics technology, ever-changing 3D perspective, software motion video, enhanced scaling and rotation and improved audio.

The 32X will enhance both Sega CD disks and Sega Genesis cartridges designed and developed exclusively for the system. In addition, the 500+ regular games available for the Sega Genesis, and the 100+ games available for the Sega CD can still be played while the 32X is attached to the Genesis hardware unit.

System Features

The following are some of the features on the 32X:

- Plugs into the Genesis Cartridge port with a pass through cartridge port.
- Run by two SH2 processors rendering to a new frame buffer on the 32X itself (not the frame buffer in the Genesis).
- Three display modes support 16 bit, 8 bit, RLE color.
- Will run 32X-only and Genesis cartridges. If the user has a Sega-CD system, 32X can be hooked up to the CD system and will run 32X-only and Sega-CD compact discs as well.
- 32X will feature improved graphics capability, more sprites, quicker animation, and allow texture mapping.
- The Genesis and 32X video/sound are mixed together. Thus, graphics and sound from both systems can be overlaid through output. For example, for any given game, the background can be done through the Genesis, and the rendering through the 32X (and vice versa).
- 4 Mbits total (2 Mbits = Frame Buffer; 2 Mbits = SD-RAM).

GSX BLOCK

Version 3/4/1994

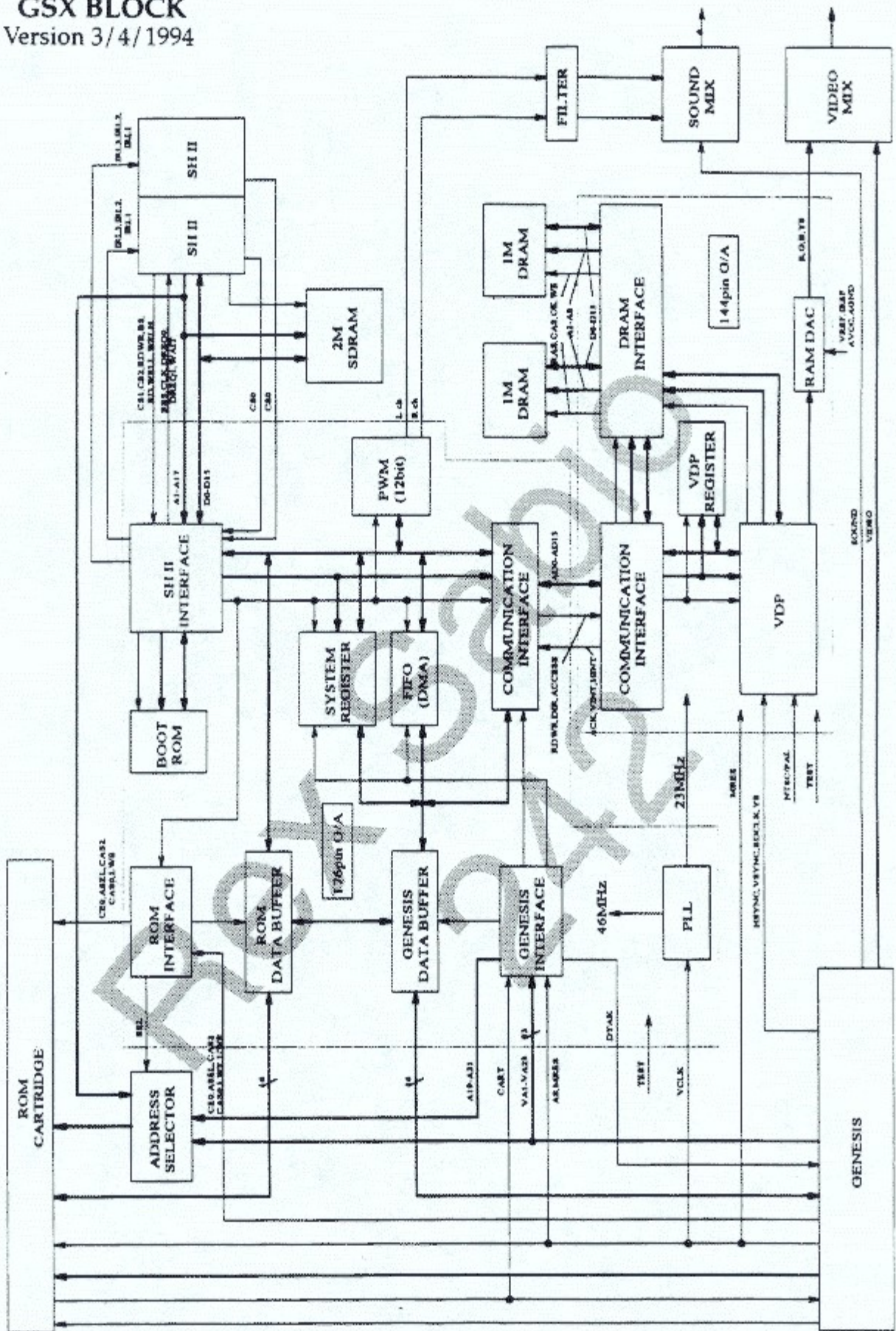

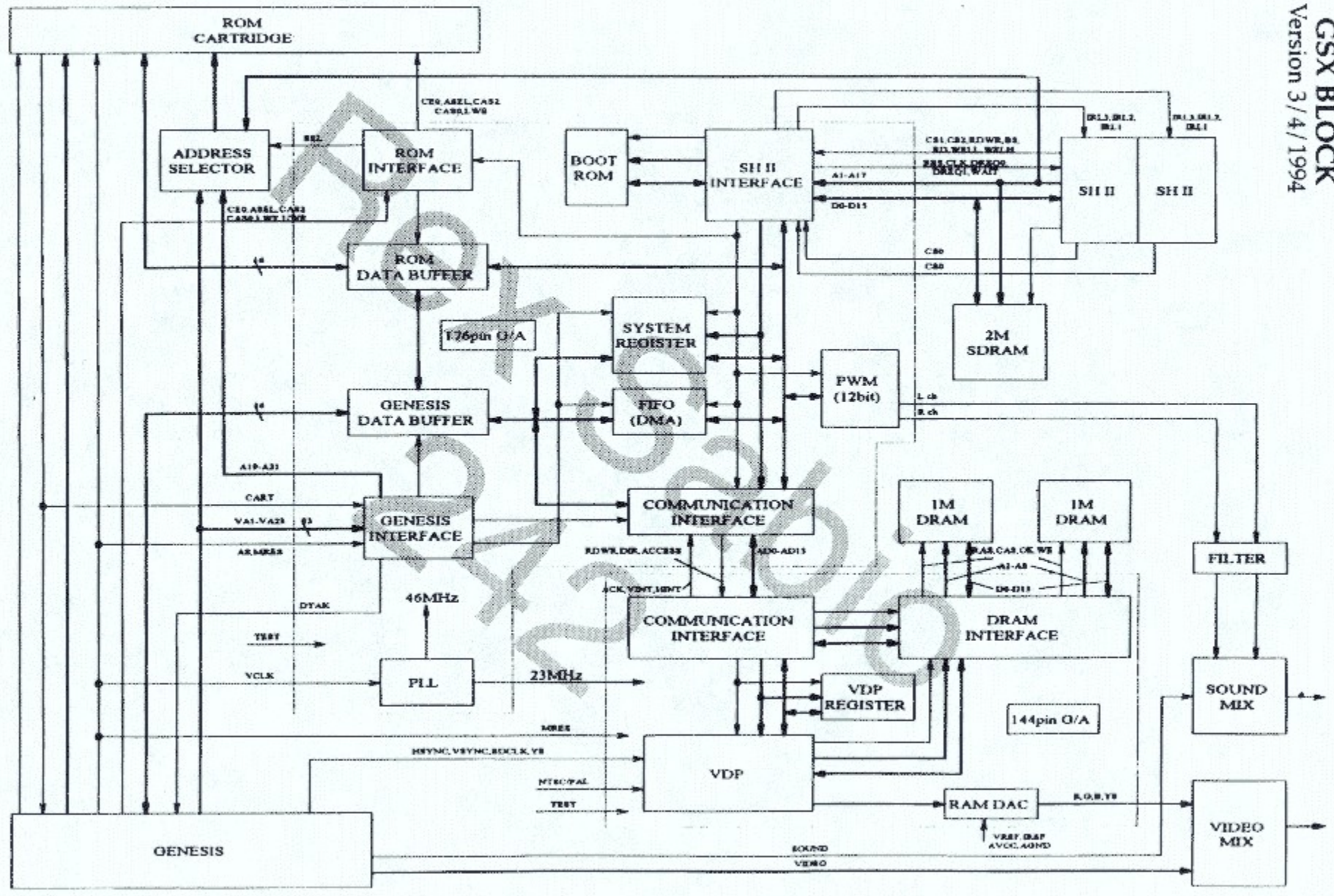

32X
HARDWARE SPECIFICATIONS

4/26/94

Rex Sabio
242

© 1994 SEGA. All rights reserved.

GSX Hardware Specifications

CPU SH2 (32 bit RISC) x 2: Internal DSP (add, times & divide):	23.01 MHz, 20 MIPS x 2, 4 KByte cache 23.01 MHz
RAM Main Work RAM: Frame Buffer:	2 Mbit SDRAM 1 Mbit x 2 DRAM
VDP Maximum screen size: Maximum colors: Display Functions:	320 pixel wide x 224 pixel high 32,768 Direct color mode, Packed pixel mode, Run-length mode, Line table method.
MD/GENESIS I/F Communication Port: Interrupts:	Eight words of dual port registers are available for communication and data transfer. An interrupt to the 32X.
Sound Two channel PWM	Resolution 10 bits at 22 kHz

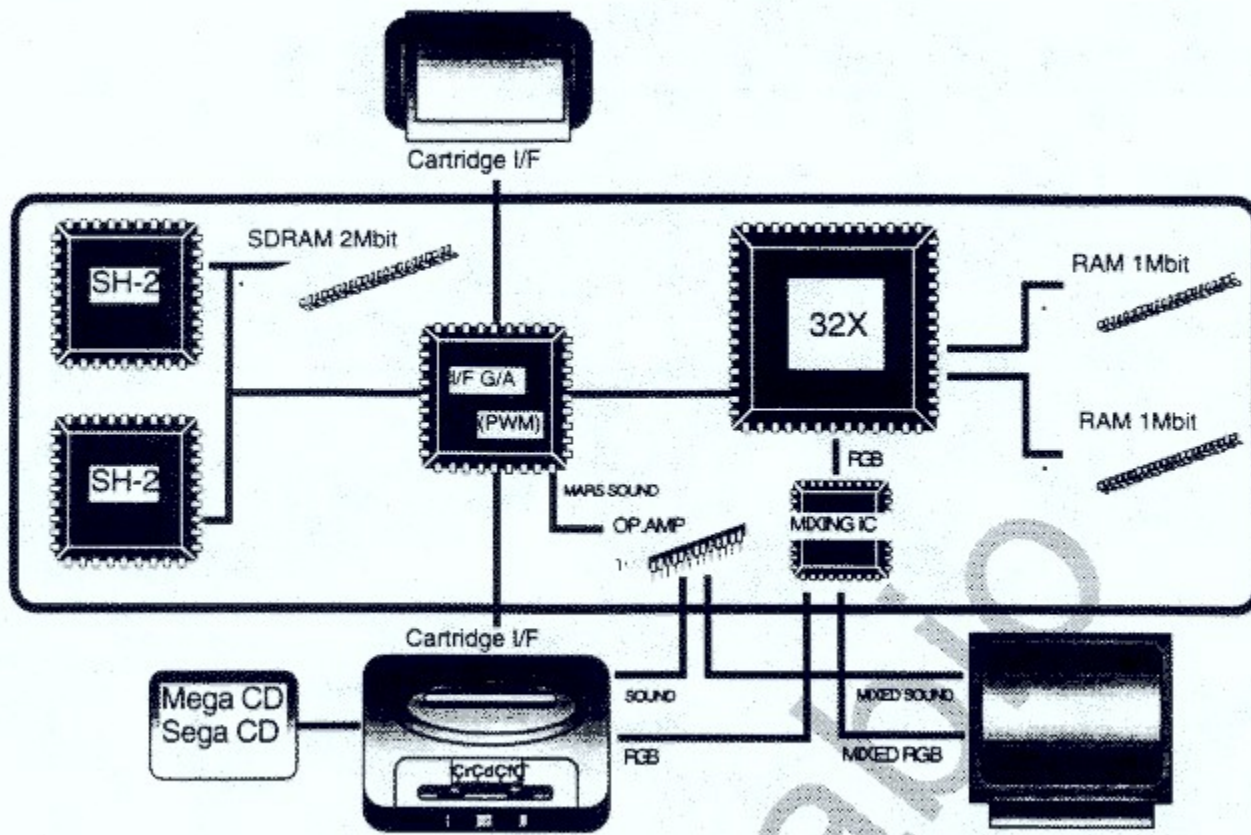

Fig. 1 32X Hardware Configuration

Rex Saino 242

SH2

Dual SH2's

Same CPU configuration as the Saturn. Each SH2 has 4K internal RAM. This RAM has two modes selectable from software. Mode 1 is 4K cache, which is useful for general CPU tasks. Mode 2 is 2K cache/2K RAM, which is useful for tight loop tasks such as graphic routines, geometry calculations, and sorting. The SH2's share a common bus that holds the RAM and Frame Buffers. This configuration should lead to unique programming tricks.

SD-RAM

The 2Mbits of SD-RAM, which is the same as what is used in the Saturn, has three timing tiers. The read time when reading sequentially is 1 cycle.

Master Access to Frame Buffers

Both CPU's reside on the same bus. When they attempt to access the bus at the same time, the Master SH2 will win. Because both SH2's have internal cache memory, the conflict rate is low. Because there is one bus, both SH2's can write to the frame buffer. This allows a programmer to split the draw work for the display into two parts if the game requires.

DMA Channels

Each SH2 has two DMA channels that can be configured to respond to the DREQ line on the chip, creating a DMA located in the background of the CPU running. On the 32X, this line toggles every time the 68000 writes to a register on the Genesis. This allows a DMA from the 68000 to the SH2 without halting the SH2 to do the DMA. This will enable the SEGA CD to do high-performance video playback and data transfers.

IRQ Lines

The 68000 has two new IRQ's, one sent to each SH2.

I/O Ports

The number of I/O ports is still undetermined. Data can be passed through I/O ports and toggle the IRQ to initiate work.

FIFO

The FIFO (First In, First Out) allows the SH2 to write data to the frame buffer without a usual wait for the D-RAM.

Cycle Stealing

The cartridge will exist on the 68000 side. Both SH2's have master/slave access to the cartridge at all times via the cycle stealing technique. Unless the 68000 is doing a DMA, the cartridge is available at all times.

RAM

System RAM

2 Mbit SDRAM

512 Byte RAM Clear Hardware

Used for flat-shaded polygons.

Frame Buffer

Dual Frame Buffer Design

Two display buffers, each 1 MBit, are featured on the 32X itself. The SH2's can talk to one of them, while the other is being drawn to the screen.

Access From MD Side

The VDP and Frame Buffer from the Mega Drive can also be accessed.

Video

Three Display Modes

The following display modes will be supported by 32X.

- Runlength/256 CLUT display mode
- 15-bit RGB 555 color display mode
- 256 CLUT display mode

32,768/256 Color Support

Supports 32,768 colors on screen at once. Each pixel can directly select its RGB color. Direct selecting of color allows movie like special effects, like cross-fading, fade wipes, gouraud shading, and photo realistic image. This is the same color depth as VDP 1 on the Saturn.

Line Start Table

Each line of the video display has a start address. This allows for special effects, memory conservation in blank pixel areas, and hardware scrolling.

S-Video Support

The 32X supports S-Video, which allows the Genesis to output S-video in pass-through mode.

Audio

Two Channel PWM

PWM registers are used for title screen audio, and the Z80 for gameplay audio.

Rex Sabio
242

32X
DEVELOPMENT TOOLS OVERVIEW

4/26/94

Rex Sabio
242

© 1994 SEGA. All Rights Reserved.

The following is a list of programming tools to be used with the GSX.

Hardware

Hardware	Comments
IBM PC compatible	Code development for SH2, 68000, Z80 CPU- 486 (66 MHz); 8 MB RAM or more; 300MB HDD or more; MS-DOS 5.0 or higher.
Macintosh	For graphic and sound tools
Unix Work Stations	Works with Hitachi E7000 through ethernet GNU tools.
Hitachi ICES for SH2 E7000PC E7000 EVAL Board	IBM-PC parallel I/F SH2 ICE Ethernet type SH2 ICE Low cost IBM-PC parallel I/F SH2 ICE
Zacks ICE	68000
CartDev	Monitor-based development system. Available in June.
SegaDev	Cartridge ROM emulator
32X Target	32X development board
CD Emulator	SEGA CD emulator

Software

Software	Comments
SH2 Compiler	GNU, Hitachi
SH2 Cross Assembler	GNU, Hitachi, SNASM2
SH2 Debugger	Hitachi with ICE, SNASM2
68000 Debugger	SNASM2, etc.

Stand-Alone System

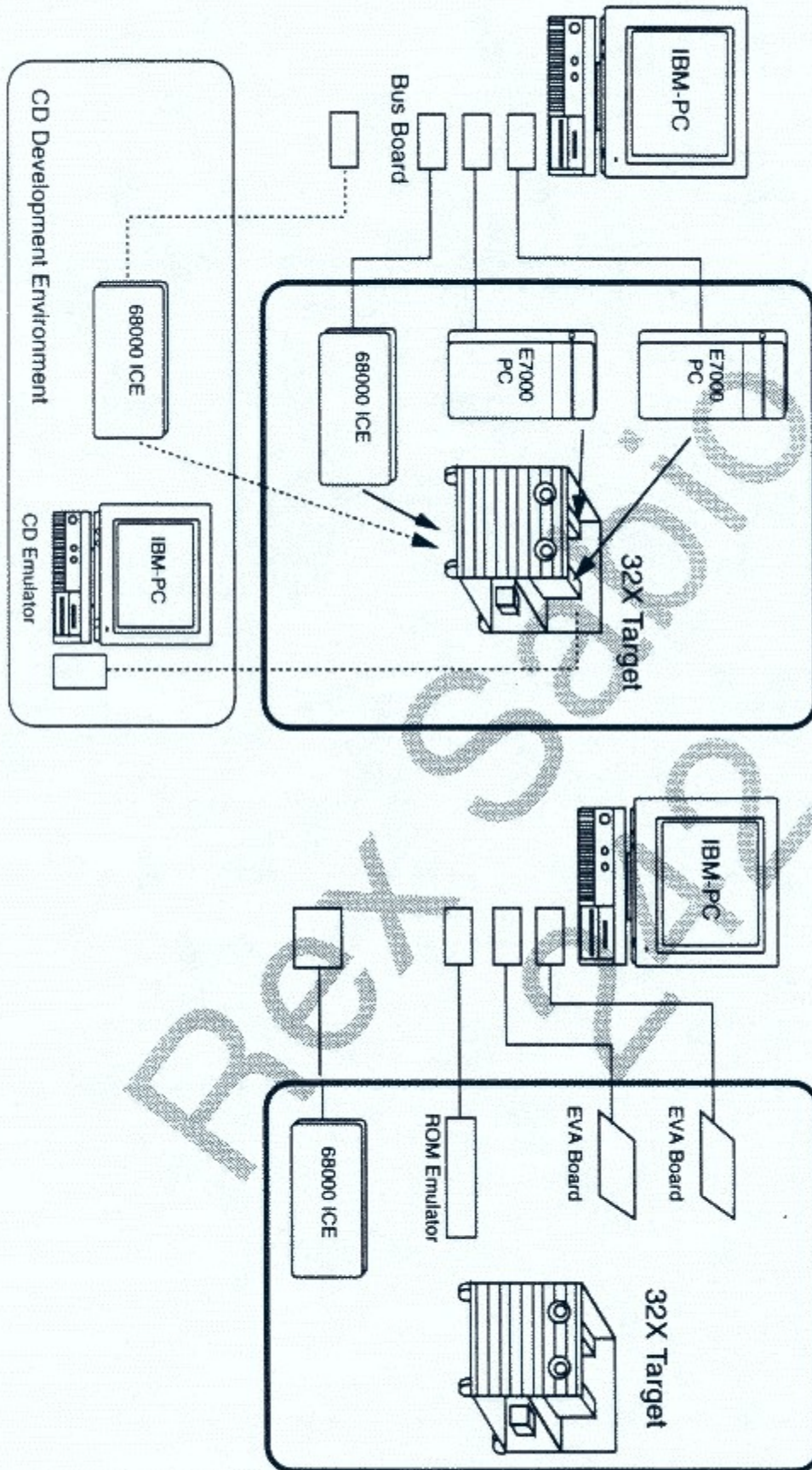

Stand-Alone System

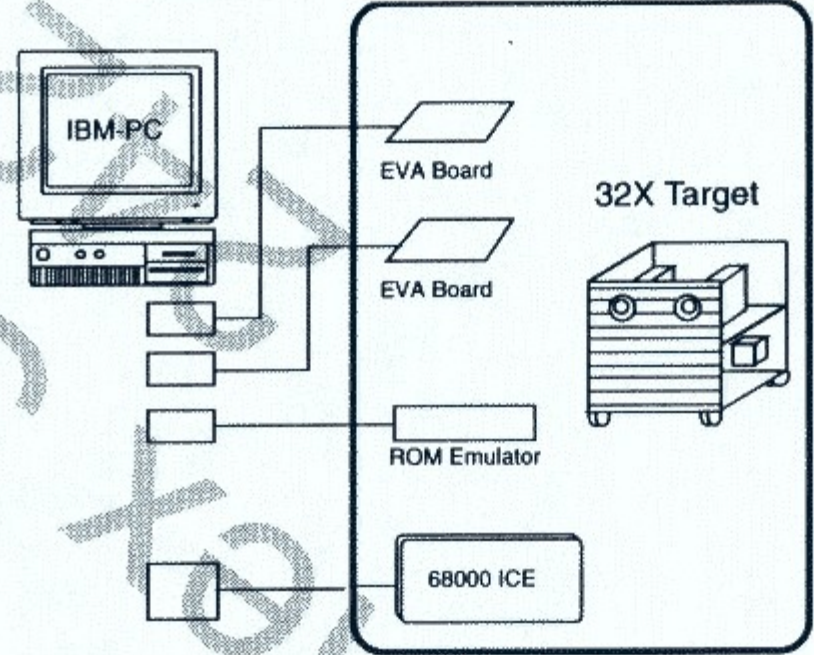
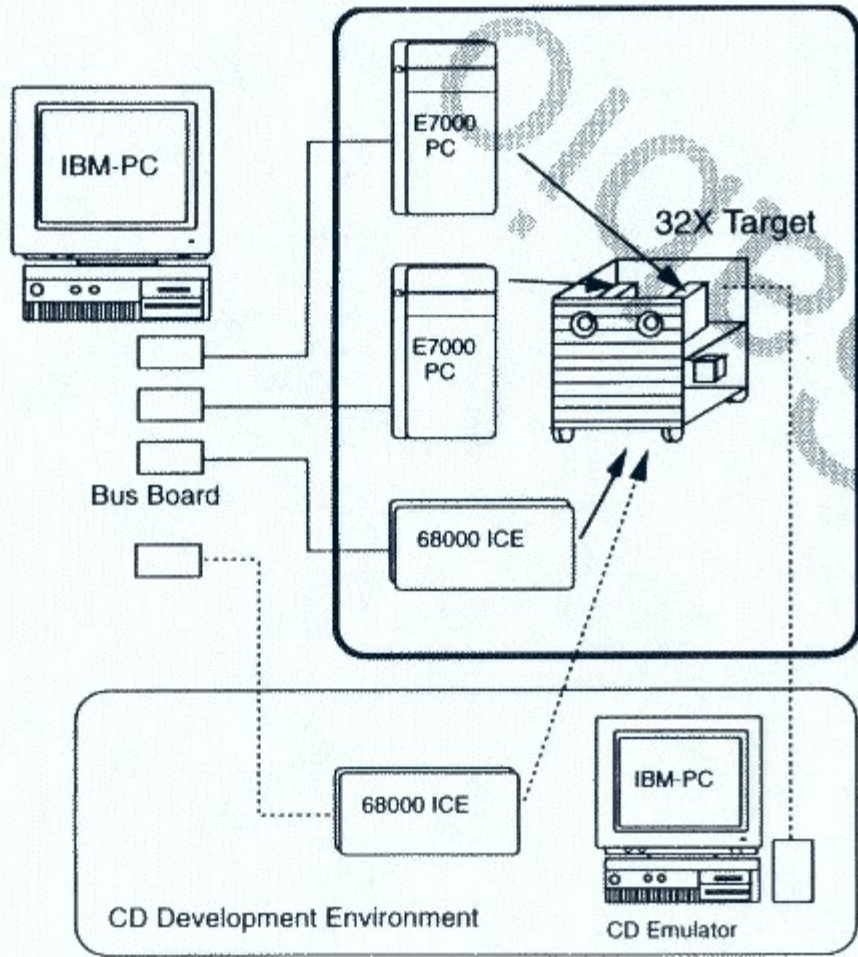

**32X
SOFTWARE LIBRARY**

4/26/94

Rex Sabio
242

© 1994 SEGA. All Rights Reserved.

32X Software Library

The following diagram list the 32X software libraries and the programs in them.

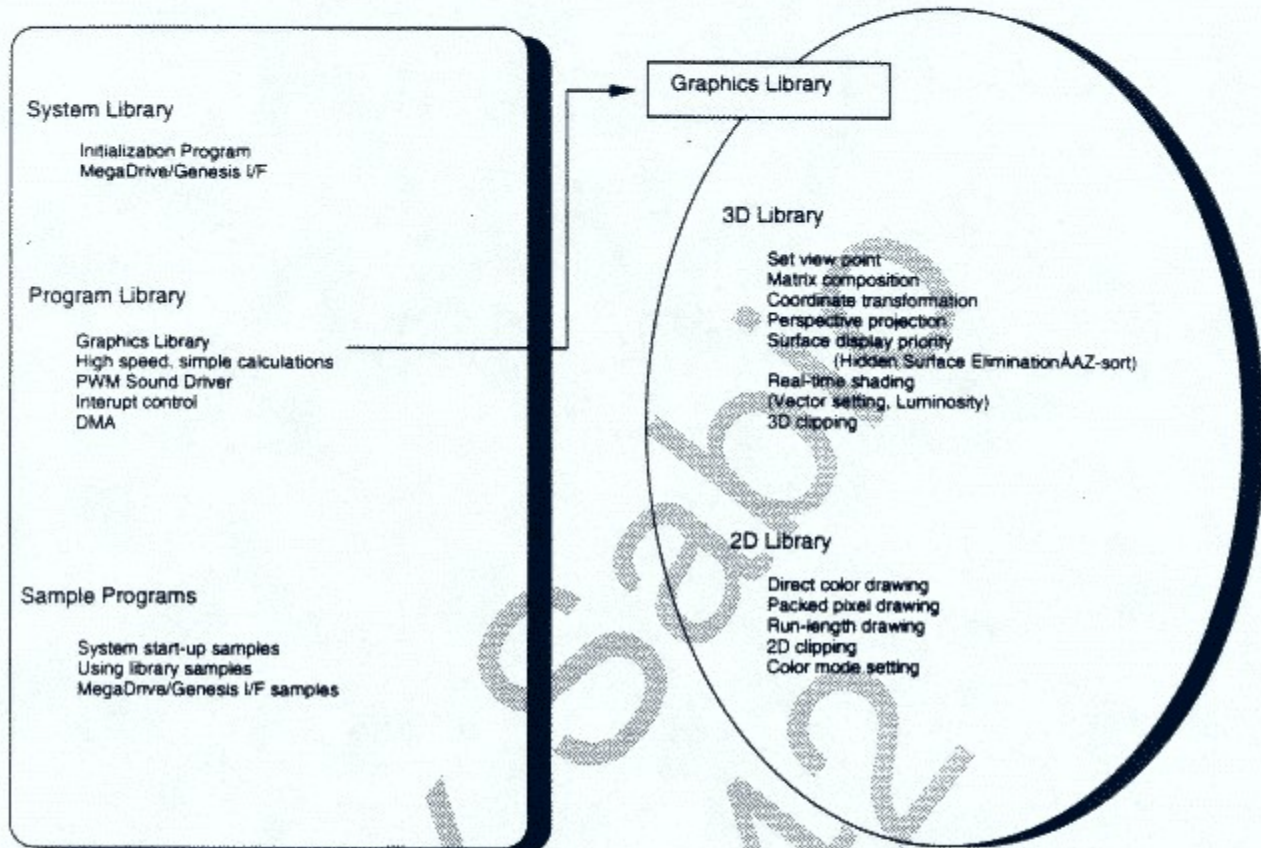

**32X
GRAPHICS DEVELOPMENT
ENVIRONMENT**

4/26/94

Rex Sabio
242

© 1994 SEGA. All Rights Reserved.

Data Format Support

The following data and formats are or will be supported.

Data type	Comment
Image Data PICT: DGT2:	Macintosh picture data DC mode, PP mode, RLE mode supported
Model Data DXF:	Auto CAD data
3D Data SEGA3D:	Modeling, Material, Object data
Animation Data PICS:	Macintosh animation data
Other Formats The following formats are scheduled to be supported in the future. <ul style="list-style-type: none">• BOB• BMP• TIFF• PCX	

2D Development

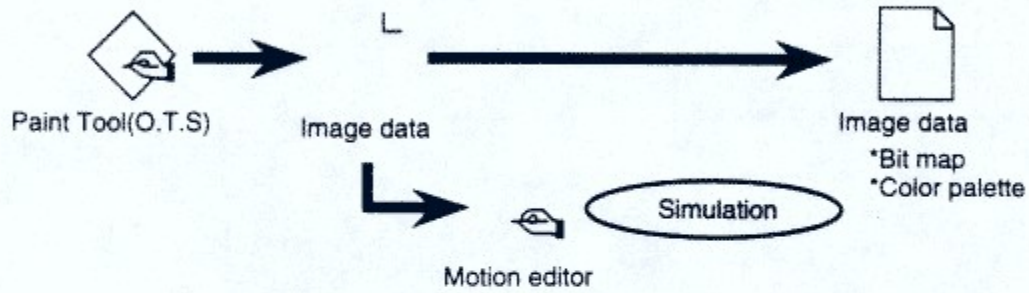

3D Development

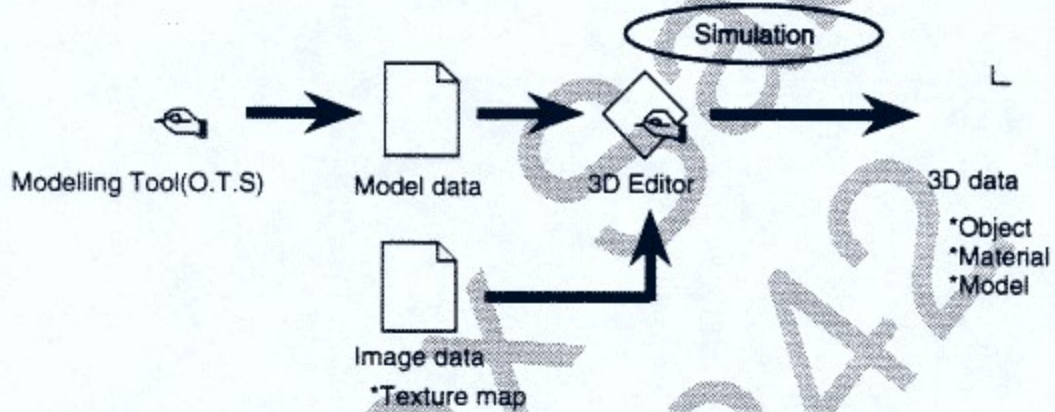

Hardware Requirements

The following hardware is required for graphic development.

Tool	Hardware	Comment
Development System:	Macintosh	CPU 68040 16MB RAM 100 MB HDD or more
Video Card:	A 24-bit Video card, or a 24-bit color system.	
Target:	A SCSI system available in June.	

System Layout

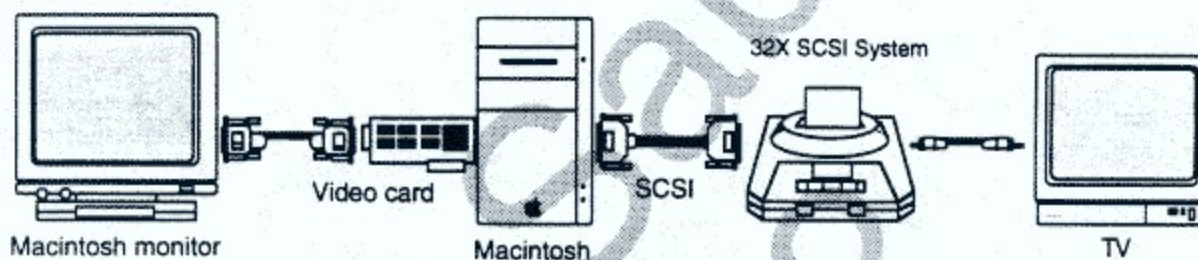

Software Requirements

The following software is required for graphic development.

Tool	Comment
2D Edit SEGA converter: Simple painter: Simple animator:	Same tool as for Saturn. Same tool as for Saturn. Same tool as for Saturn.
3D Edit Simple 3D editor:	Same tool as for Saturn.

Simple Painter

A simple paint tool.

Function	Simple paint tool
Input:	Image data is PICT, DGT2
Output:	Image data is PICT, DGT2

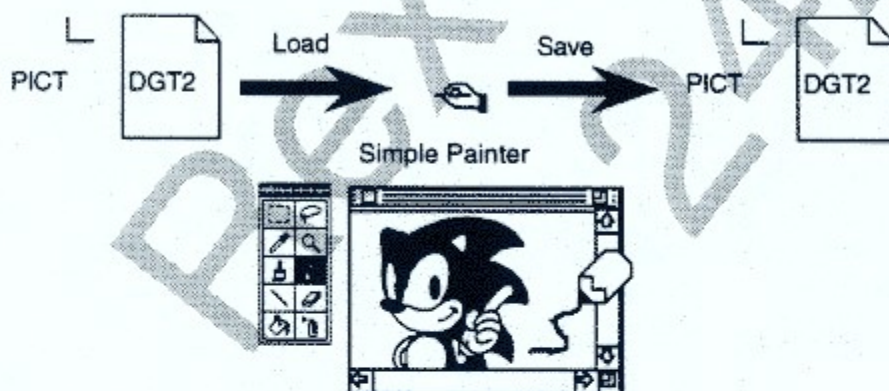

Simple Animator

A sprite animation tool.

Function	Sprite animation tool
Input:	Image data is PICT, DGT2 Animation data is PICS
Output:	Animation data is PICS

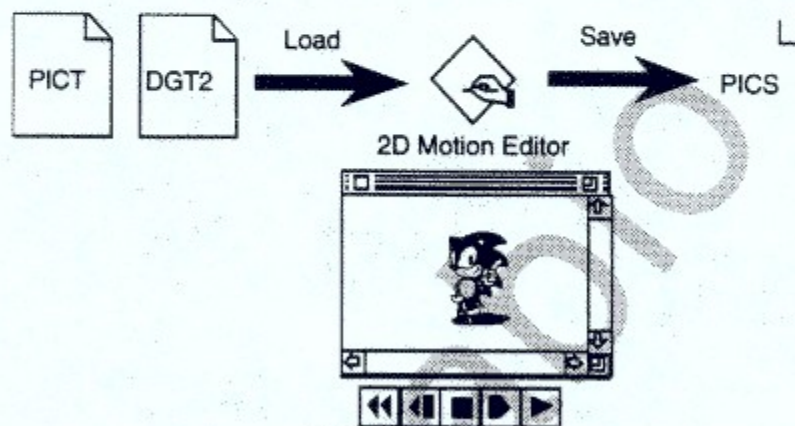

Rex S 242

Simple 3D Editor

A model data viewer that sets 3D data (material, object).

Function	Model data viewer
Input:	Model data is DXF 3D data is SEGA3D Image data is PICT, DGT2 (for texture mapping)
Output:	3D data: SEGA3D

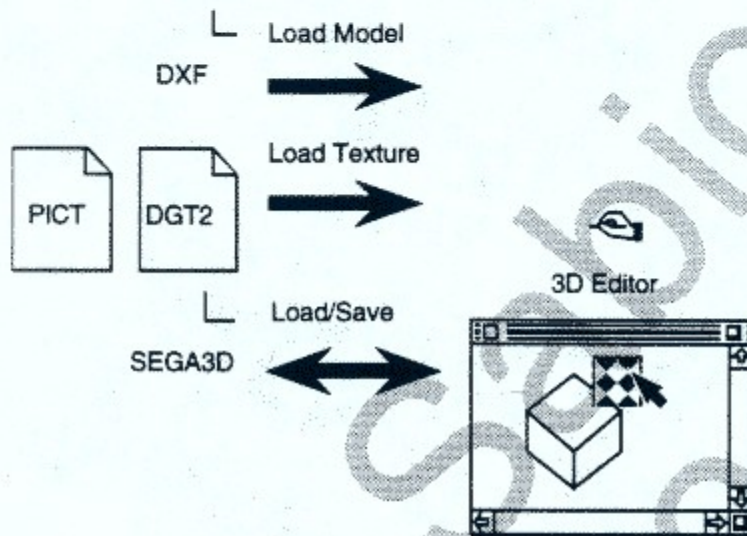

SEGA Converter

A data format conversion tool.

Function	Data format conversion
Input:	Image data is PICT, DGT2 (TIFF, BMP, PCX are being planned)
Output:	Image data is PICT, DGT2 (TIFF, BMP, PCX are being planned)



32X
SOUND DEVELOPMENT
ENVIRONMENT

4/26/94

Rex Sabio
242

© 1994 SEGA. All Rights Reserved.

GSX Sound Control Plan

2WORDS will be set aside for the 32X communication port. Of the 2 WORDS, 1 WORD will be used for main program (SH2) sound requests. The remaining 1 WORD is exclusively for the sound driver give-and-take control over SH2 and 68000.

PWM Sound Driver

The following are some of the functions of the PWM sound driver:

- 8 bit data
- Left and right, 2-channel PWM.
- Maximum sampling rate of 44.1 KHz.
- Looping (forward, alternate).
- 32 step volume change.
- 3 cent step pitch control.
- **CPU Power Consumption**
 - Pitch, volume control off- 2 μ s (22 μ sec)
 - Pitch, volume control on- 20 μ s (22 μ sec)

Presently, the SH2 timer is fixed at 22 μ sec.

PWM Data Format

Divide PWM data into the following information and data areas.

Information areas

TOP ADRS.	LONG
LOOP START ADRS.	LONG
LOOP POINT ADRS.	LONG
ORIGINAL SAMPLING KEY	WORD
ENVELOPE VOLUME	WORD
PAN	WORD
NOTE ON/OFF	WORD
STATUS	WORD
FREQUENCY	WORD

Data area

Wave data converted to PWM format.

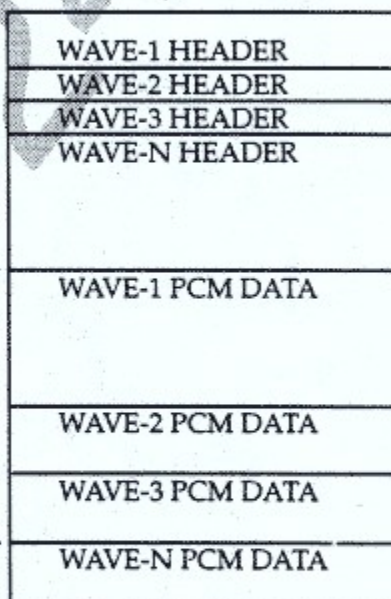

GSX Sound Development Environment

Sound Program Development Layout

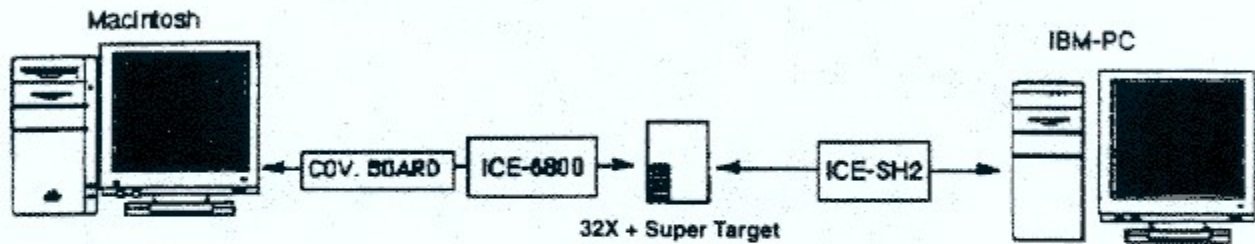

Sound/Music Composition

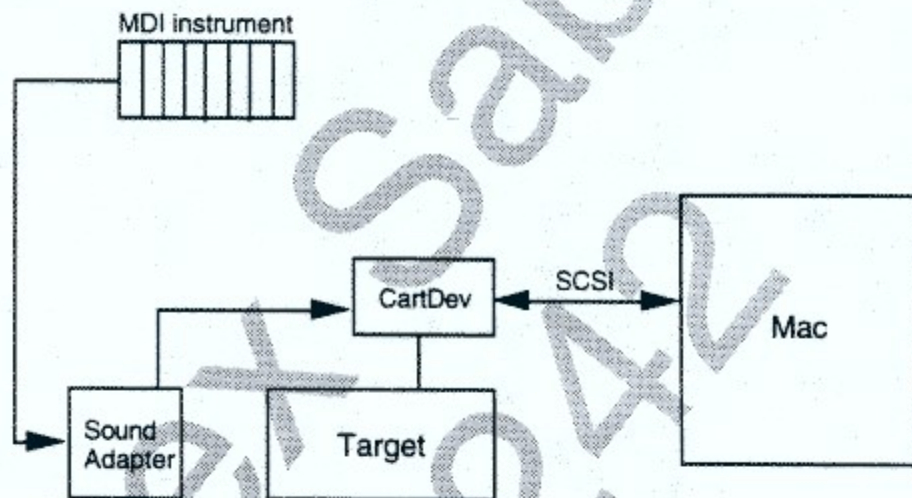

Program Development

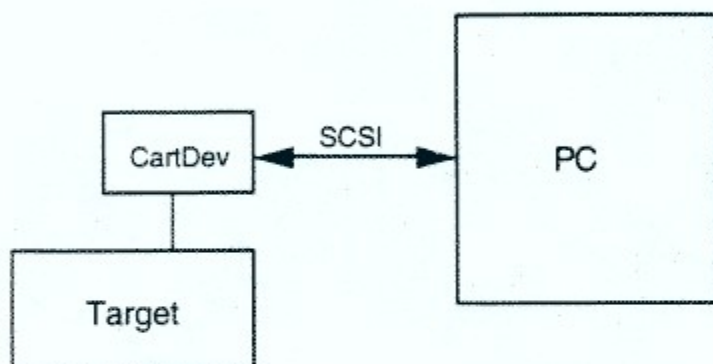

When the 32X available, development can be done on the game system as follows:

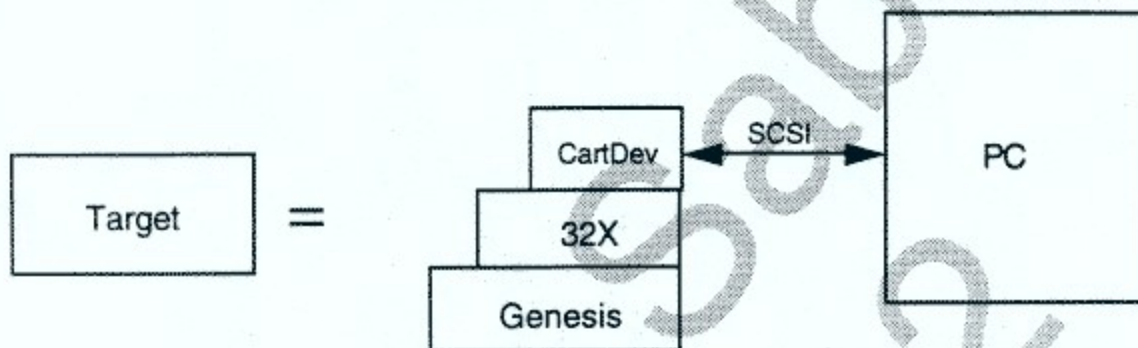

32X HARDWARE MANUAL

(Doc. # MARS-10-032394)

Rex Sabio
242

© 1994 SEGA. All Rights Reserved.

MD MEMORY MAP

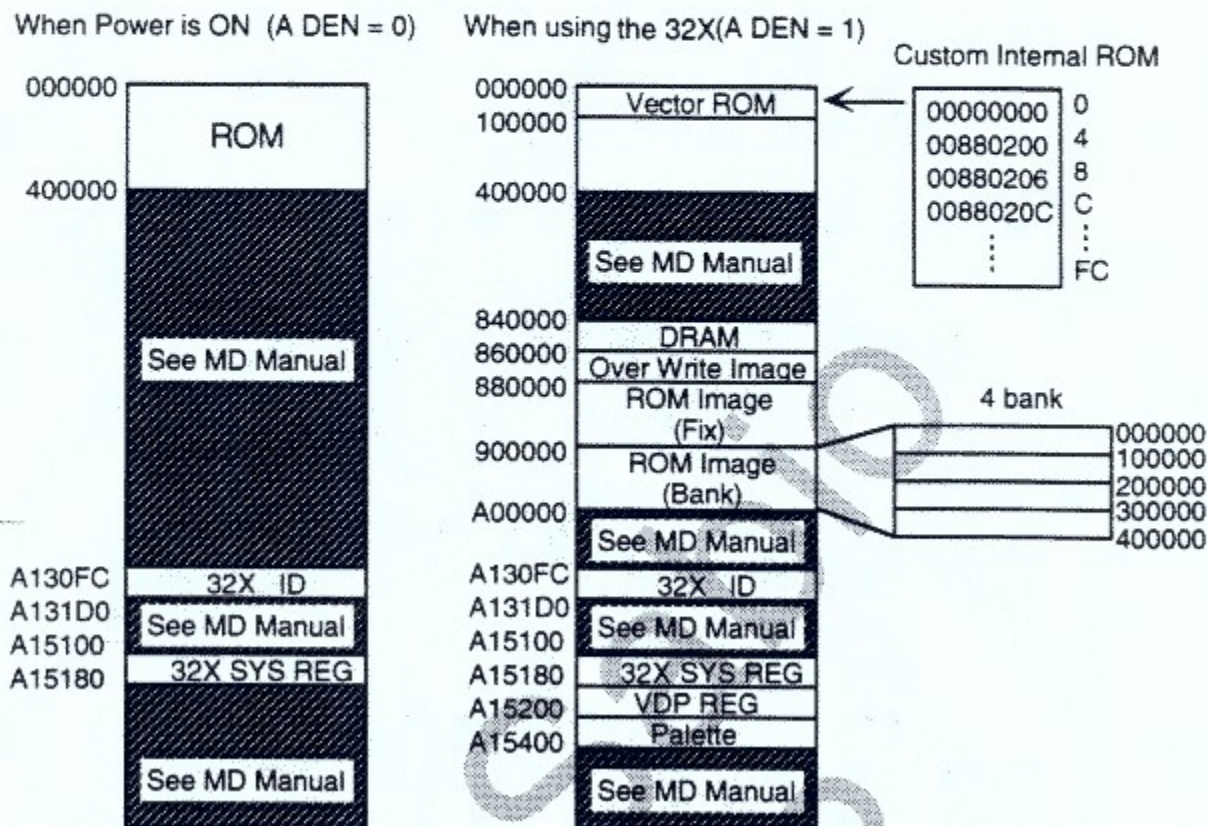

When Using 32X (A DEN = 1)

- A custom internal ROM is allocated to 68K Vector area (\$000000~\$0000FF). All Jump destinations with this RAM are to FIX ROM. Image area cartridge ROM is allocated to this area only when ROM to VRAM DMA.
- The cartridge \$000000~\$07FFFF (4 Mbit) area is allocated to the \$880000~\$8FFFFFFF area, and cannot allocate other cartridge ROM areas.
- The \$900000~\$9FFFFFFF area accesses a 32 Mbit cartridge area and divides it into four banks by setting the bank inside SYSREG.
- 68K and SH2 can freely access ROM, but when 68K and SH2 are accessed at the same time, SH2 has priority. The CPU then waits until the access before it has ended.
- Only the H INT (Level 4) Vector becomes RAM.
- The Jump source is set to the Fix ROM Image area when the initial program ends.

- Only when FM equals 0 within SYSREG is access of areas \$840000 ~ \$87FFFF and \$A15100 ~ \$A153FF possible.
- The 32X ID is "MARS."
- Palette can access only by word; it can not access by byte.

Rex Sabio
242

SH2 Memory Map

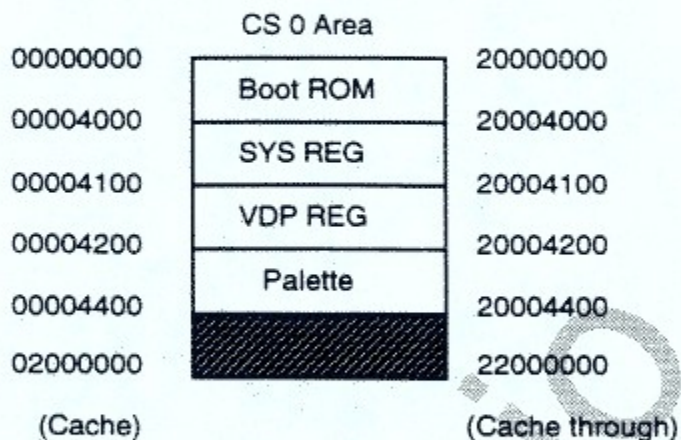

(Only when FM = 0 within SYSREG
can VDP REG and Palette access.)

Palette can access only by word; it can not access by byte.

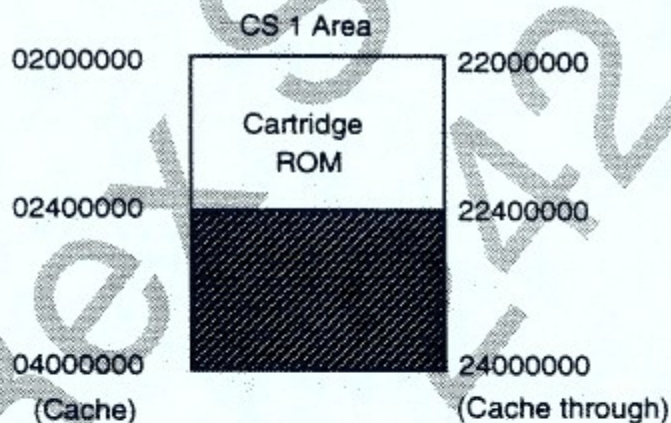

(Write Protect)

(Access prohibited when RV=1
within SYS REG)

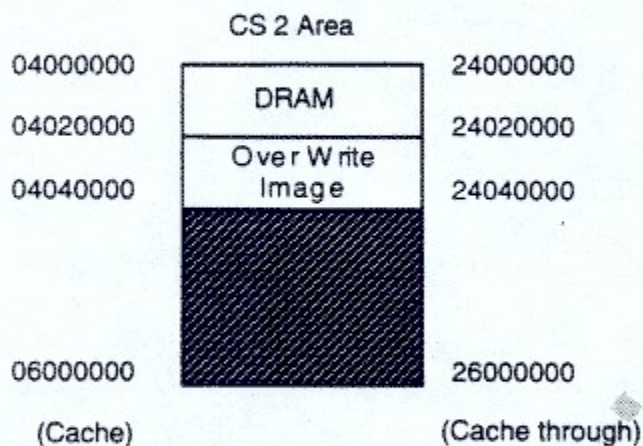

(However, Accessable only
when FM=1 inside SYSREG)

With Write FIFO, write is possible by 3 Sclk. Because there are only two words, a wait is required when more is written continuously.

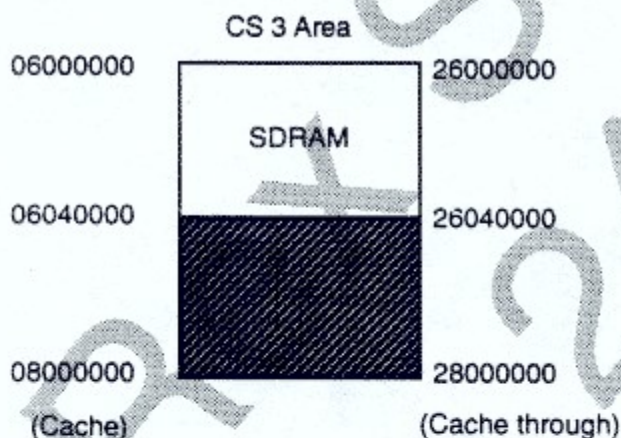

Interrupt Levels

IRL 14	VRES	Interrupt when the MD reset button has been pressed
12	VINT	V Blank Interrupt
10	HINT	H Blank Interrupt
8	CMD INT	Interrupt through register set from MD side
6	PWM TIMER	Interrupt through PWM synchronous timer

DMA

- DMA is a dual address mode (DREQ 0 fixed) for the SH side RAM from FIFO (MD side data).
- The ROM to PWM DMA is also a dual address mode.
- For other memory to memory DMA, use the auto request mode.
- DMA can set both master and slave, but both should not be set at the same time.
- When scanning MD DMA data in DMA for the SH side RAM from FIFO, the MD Source Address works properly only by the CD word RAM. FIFO will not run properly even if you set the MD work RAM.

Rex Saito
242

MD side SYS REG

◆ Adapter Control Register

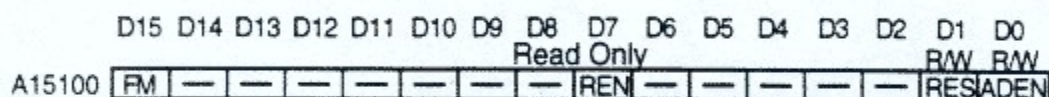

- ADEN: Adapter Enable Bit
 0: Prohibits use of 32X (initial value)
 1: Permits use of 32X
- RES: Resets SH2
 0: Reset (initial value)
 1: Cancel reset
- REN: SH Reset Enable
 0: No
 1: Yes
- FM: Frame Buffer Access Permission
 0: MD (initial value)
 1: SH

Switching the access permission is done simultaneously to writing to the FM bit. Therefore, be aware that the SH side will switch even while accessing the VDP.

◆ Interrupt Control Register

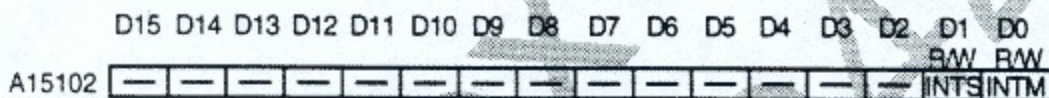

- INTM: Master SH2, Interrupt command
 0: NO OPERATION (initial value)
 1: Interrupt command
- INTS: Slave SH2, Interrupt command
 0: NO OPERATION (initial value)
 1: Interrupt command

Both are automatically cleared if SH performs interrupt clear.

◆ Bank Set Register

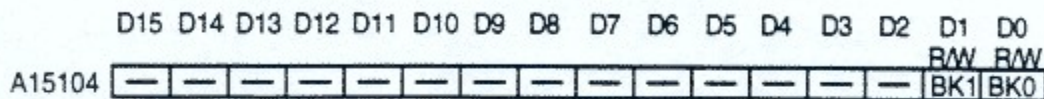

◆ DREQ Control Register

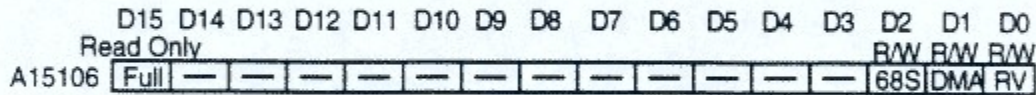

RV: ROM to VRAM DMA
 0: NO OPERATION (initial value)
 1: Start DMA

Full: FIFO Full
 0: Writeable
 1: Unwriteable

The SH side cannot access the ROM when RV = 1. (When doing ROM to VRAM DMA, be sure that RV=1) When you want to access it, wait until RV=0. (When DEL=1 no action will occur even when writing to FIFO.)

DMA	68S	Mode
0	0	No Operation
0	1	CPU Write (68K writes data in FIFO)
1	0	No Operation
1	1	DMA Write (Performs data capture using MD side DMA) <small>* Valid only when CD is connected.</small>

The 32X begins operation when 68S is 1. Writing 0 ends the operation. It automatically becomes 0 after DMA ends.

◆ 68 TO SH DREQ Source Address

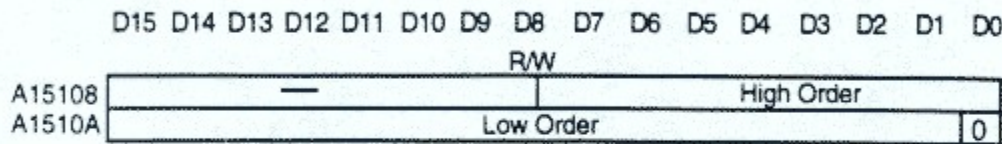

Sets the source address when performing DMA of the MD side. The inside circuit begins operation of the SH side DREQ circuit from the time that the addresses match. But because the DREQ circuit does not use this data, nothing needs to be set at the time of CPU WRITE.

◆ 68 TO SH DREQ Destination Address

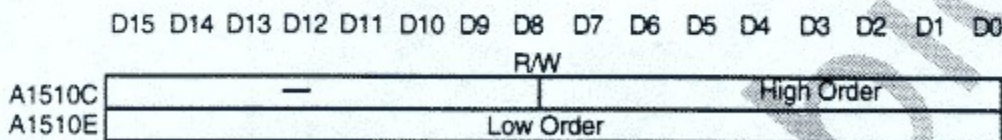

Sets the SH side (SDRAM) address. The DREQ circuit does not use this data. Thus, when the destination address is known beforehand by SH, or when SH doesn't need to know, no settings are needed.

◆ 68 TO SH DREQ Length

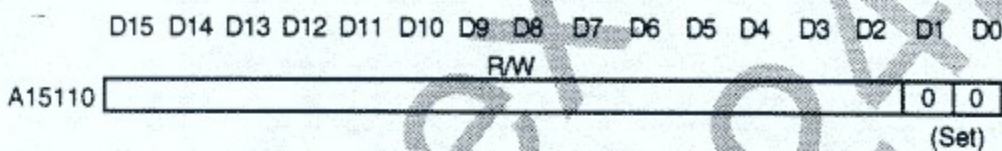

Sets the data number (Units: Word) to be sent to SH side. The value to be set is in 4 word units. Low order 2 bit write is ignored (00 defined). Be sure to set this register for both CPU WRITE and DMA WRITE. At each transfer, this register is decremented and when it becomes 0, the DREQ operation ends. Transfer is done 65636 times when 0 is set. Read time reads the actual count value.

◆ FIFO

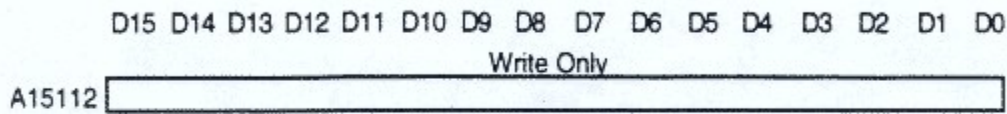

Data is written to this register when DREQ is used by CPU WRITE.

◆ SEGA TV Register

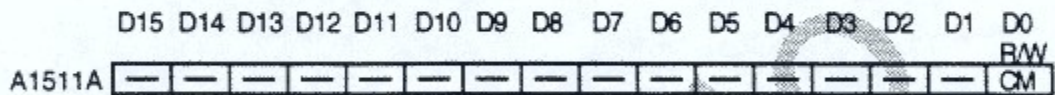

CM: Cartridge Mode
 0: ROM (initial value)
 1: DRAM

Use of this bit is prohibited with other applications for the SEGA TV.

◆ Communication Port

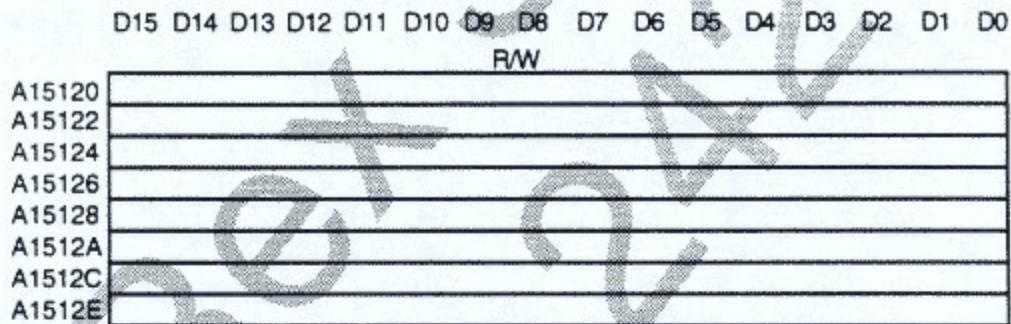

This is an 8 word bi-directional register. Read/write is possible from both the MD and SH directions, but be aware that if writing the same register from both at the same time, the value of that register becomes undefined.

◆ PWM Control

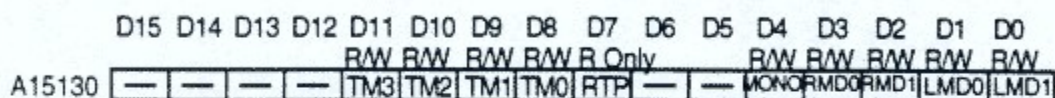

RTP: DREQ 1 occurrence enable (SH side only).
 0: OFF (initial value)
 1: ON

MONO: Sets stereo/mono
 0: stereo (initial value)
 1: mono

When set at mono only registers used for mono are valid.

RMD0	RMD1	OUT	LMD0	LMD1	OUT
0	0	OFF	0	0	OFF
0	1	R	0	1	R
1	0	L	1	0	L
1	1	no setting	1	1	no setting

Neither can be set to Lch or Rch.
 Cycle Register: base clock $f = 23.01$ MHz (fixed)

Δ TIM 0 ~ 3 sets the PWM time interrupt interval as well as the ROM to PWM transfer synchronization. Interrupt is produced by:

$$(\text{cycle register set value} \times \text{TM cycle})$$

◆ Cycle Register

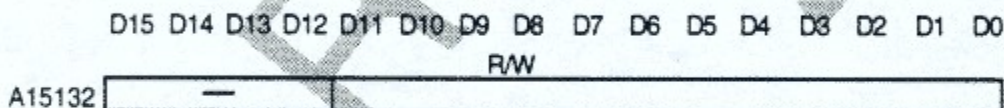

The set value x cyc becomes the cycle

$$\text{NTSC } Scyc = 1/23.01 \text{ [MHz]}$$

$$\text{PAL } Scyc = 1/22.8 \text{ [MHz]}$$



◆ **L ch Pulse Width Register**

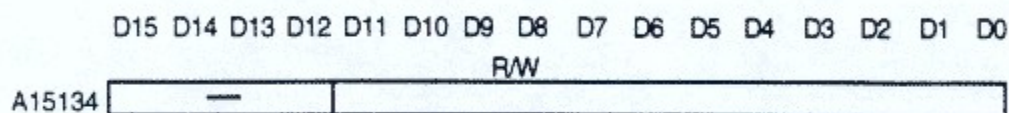

The set value x cyc becomes the pulse width.

◆ **R ch Pulse Width Register**

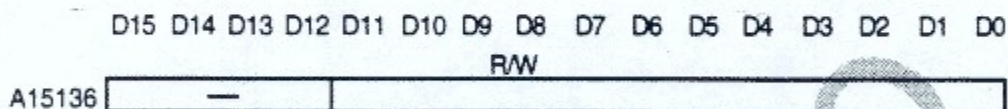

The set value x cyc becomes the pulse width.

◆ **Mono Pulse Width Register**

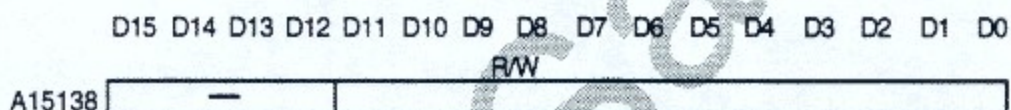

The set value x cyc becomes the pulse width.

If writing to this register, the same value is written to both Lch and Rch.

SH side SYS REG

◆ Interrupt Mask

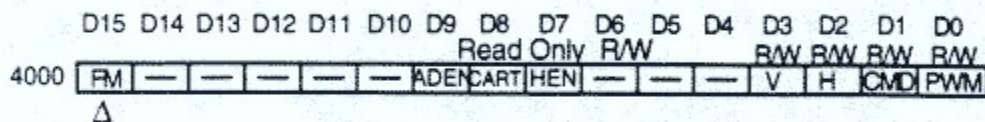

- HEN: H INT approval within V Blank
 0: H INT not approved (initial value)
 1: H INT approved
- H: H Interrupt Mask
 0: Mask (initial value)
 1: Effective
- V: V Interrupt Mask
 0: Mask (initial value)
 1: Effective
- CMD: Command Interrupt Mask
 0: Mask (initial value)
 1: Effective
- PWM: PWM time interrupt mask
 0: Mask (initial value)
 1: Effective
- Cart: Cartridge insert condition
 0: is inserted
 1: is not inserted
- ADEN: Adapter enable bit
 0: 32X use prohibited
 1: 32X use allowed
- Δ FM: Frame Buffer Access Permission
 0: MD (initial value)
 1: SH

D0 ~ D3 have separated registers in master and slave. Switching access permission is done simultaneously to writing to the FM bit. Therefore, be aware that the MD side will switch even while accessing the VDP.

◆ Stand By Change

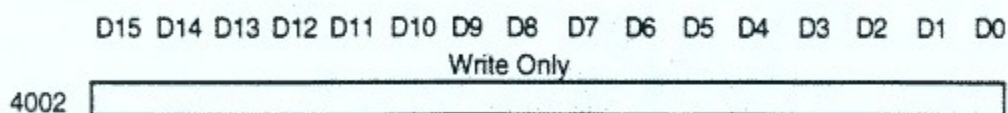

Use with system (Boot ROM). Access to this register from the application is prohibited.

◆ H Count (Access : Byte/Word)

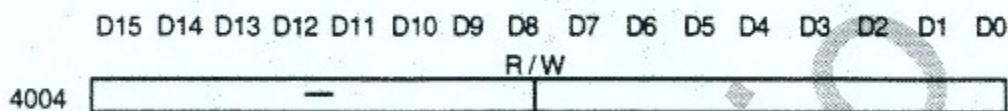

Sets H int occurrence interval.
0 = each line (default)

◆ DREQ Control Register (Access : Byte/Word)



Full: Frame Buffer, Right Cache Full
0: Space
1: No Space
EMPTY: Frame Buffer, Right Cache Empty
0: Data
1: No Data

For others see MD side

◆ 68 to SH DREQ Source Address (Access : Word)

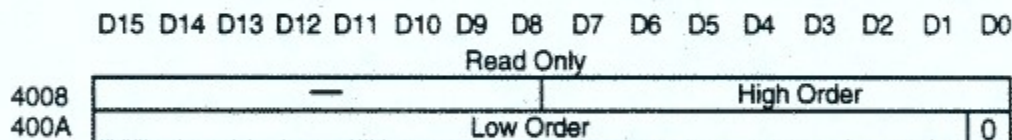

See MD side

◆ 68 to SH DREQ Destination Address (Access : Word)

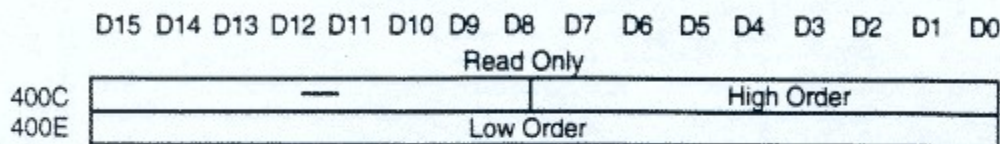

See MD side

◆ 68 to SH DREQ Length (Access : Word)

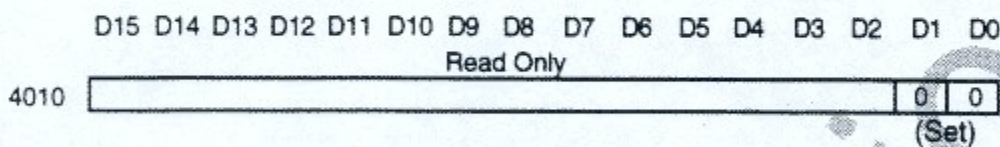

See MD side

◆ FIFO (Access : Word)

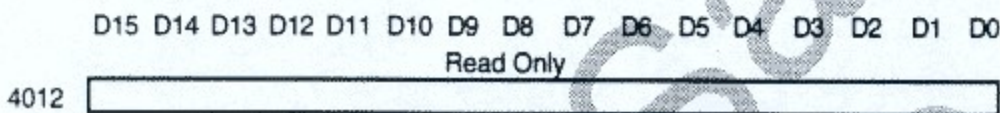

See MD side

◆ VRES Interrupt Clear (Access : Word)

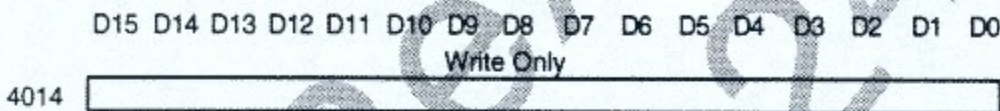

Clears VRES interrupt. If not cleared, interrupt will continue indefinitely.

◆ V Interrupt Clear (Access : Word)

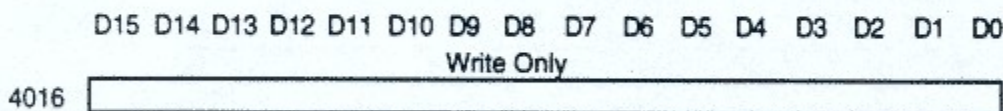

Clears V interrupt. If not cleared, interrupt will continue indefinitely.

◆ **H Interrupt Clear**

(Access : Word)

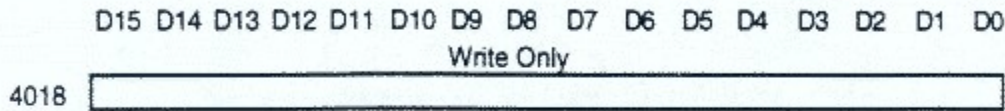

Clears H interrupt. If not cleared, interrupt will continue indefinitely.

◆ **CMD Interrupt Clear**

(Access : Word)

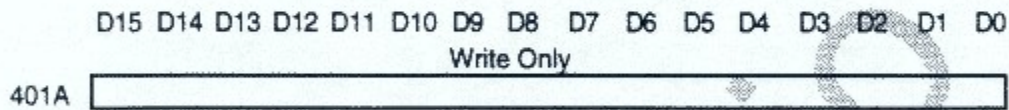

Clears CMD interrupt. If not cleared, interrupt will continue indefinitely.

◆ **PWM Interrupt Clear**

(Access : Word)

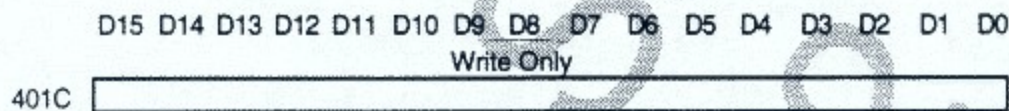

Clears PWM interrupt. If not cleared, interrupt will continue indefinitely.

◆ **Communication Port**

(Access : Byte/Word)

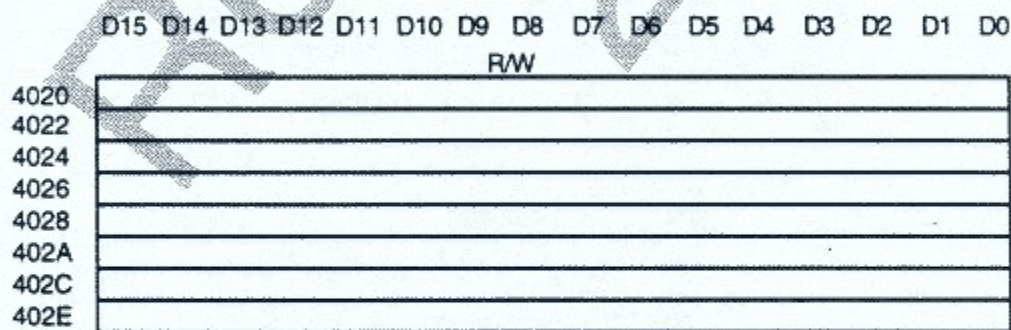

See MD side

◆ PWM Control

(Access : Byte/Word)

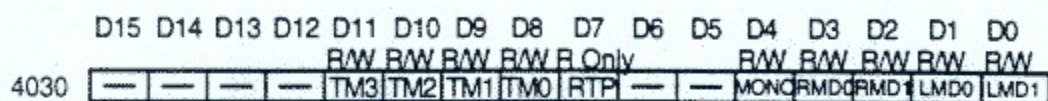

See MD side

◆ Cycle Register

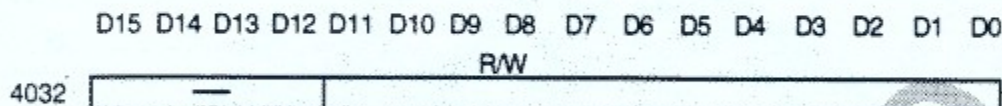

See MD side

◆ L Pulse Width Register

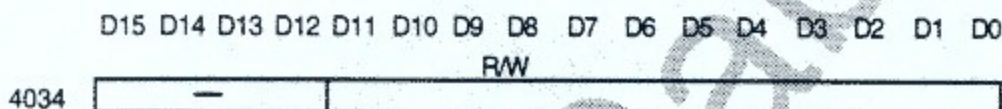

See MD side

◆ R Pulse Width Register

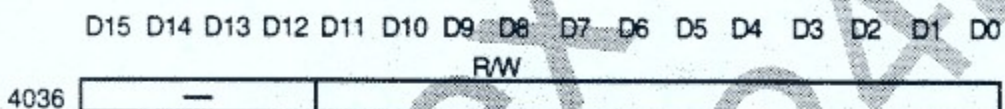

See MD side

◆ Mono Pulse Width Register

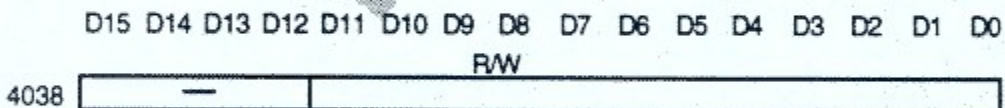

See MD side

VDP REG

MD and SH Common

◆ Bit Map Mode

(Access : Byte/Word)

Address		D15	D14	D13	D12	D11	D10	D9	D8	D7	D6	D5	D4	D3	D2	D1	D0
MD	SH	Read Only								R/W R/W				R/W R/W			
A15180	4100	PAL	—	—	—	—	—	—	—	PRI	240	—	—	—	—	M1	M0

M1	M0	Mode
0	0	Blank
0	1	Packed Pixel Mode
1	0	Direct Color Mode
1	1	Run Length Mode

240: 240 Line Mode (Valid only when PAL)

0: 224 Line (initial value)

1: 240 Line

Changing can only be done within V Blank

PRI: Screen Priority (explained later)

0: MD has priority (initial value)

1: 32X has priority

Change can be done anytime but is valid from the next line.

PAL: TV format

0: PAL

1: NTSC

◆ Packed Pixel Control

(Access : Byte/Word)

Address		D15	D14	D13	D12	D11	D10	D9	D8	D7	D6	D5	D4	D3	D2	D1	D0	
MD	SH																R/W	
A15182	4102	—	—	—	—	—	—	—	—	—	—	—	—	—	—	—	—	SFT

SFT: Screen dot left shift (explained later)

0: OFF

1: ON

Change can be done anytime but is valid from the next line.

◆ Auto Fill Length

(Access : Byte/Word)

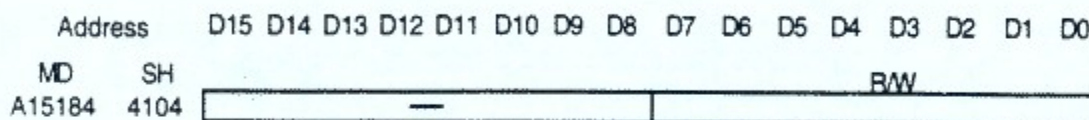

Word length (0~255) when DRAM is being filled.

Note: The Auto Fill function will be explained later.

◆ Auto Fill Start Address

(Access : Byte/Word)

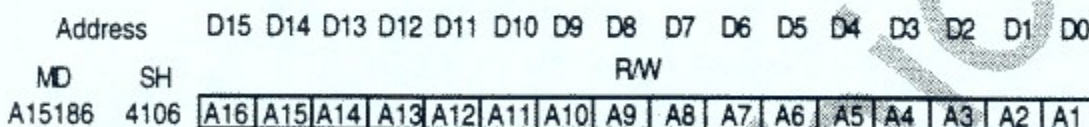

Sets the lead of the address you want to fill. A16 ~ A9 remain as set but A8 ~ A1 are incremented at each Fill.

◆ Auto Fill Data

(Access : Byte/Word)

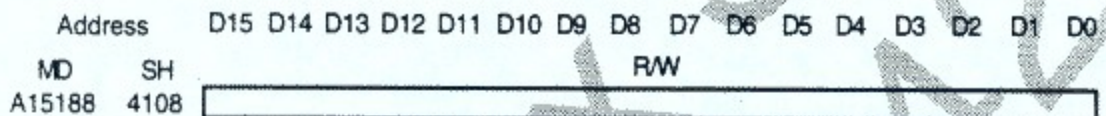

Sets data to be filled. The Fill operation will begin by setting this register.

◆ Frame Buffer Control

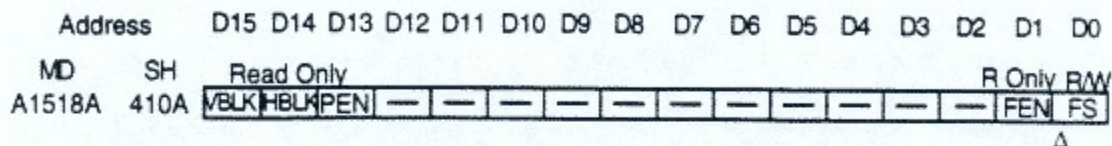

- FS: Frame Buffer Swap
 0: Transfers DRAM0 to VDP side (initial value)
 1: Transfers DRAM1 to VDP side
- FM: Frame Buffer Access Right
 0: MD (initial value)
 1: SH
- FEN: Frame Buffer Access authorization
 0: Access allowed (initial value)
 1: Access denied
- VBLK: V Blank
 0: During display period
 1: While Blank
- HBLK: H Blank
 0: During display period
 1: While Blank
- PEN: Palette Access Approval
 0: Access approved
 1: Access denied

Change of the FS Bit is possible only during V Blank (VBLK = 1). When changing FS Bit, FM bit, and performing FILL, be sure to access the Frame Buff after confirming that FEN is equal to 0. Palette access is possible only during H and V blank. The bit map mode can access at anytime when in the direct color mode as well as Blank.

VDP

◆ Data Format

Run Length Mode

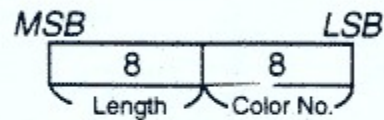

Length is the display dot number minus 1.
1 dot when Length = 0

Packed Pixel Mode

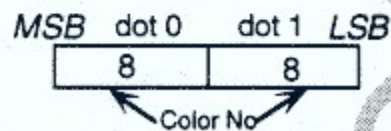

Direct Color Mode

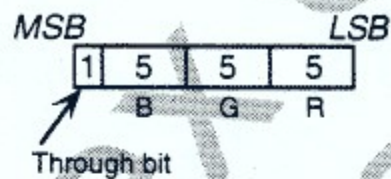

Color Data when Run Length and Packed Pixel

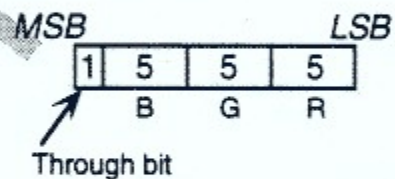

◆ Priority

VDP Register PRI = 0

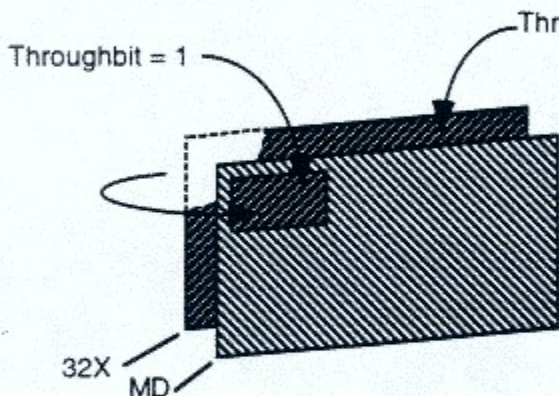

PRI = 1

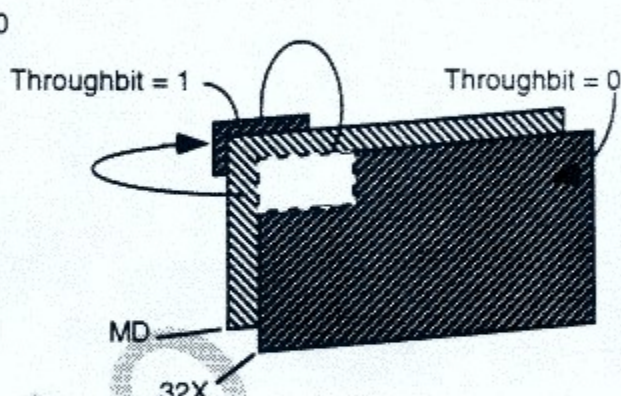

- The MD surface is transparent when Color No. = 0.
- Only the MD surface is displayed when in the Blank Mode.

◆ DRAM (FRAME Buffer) MAP

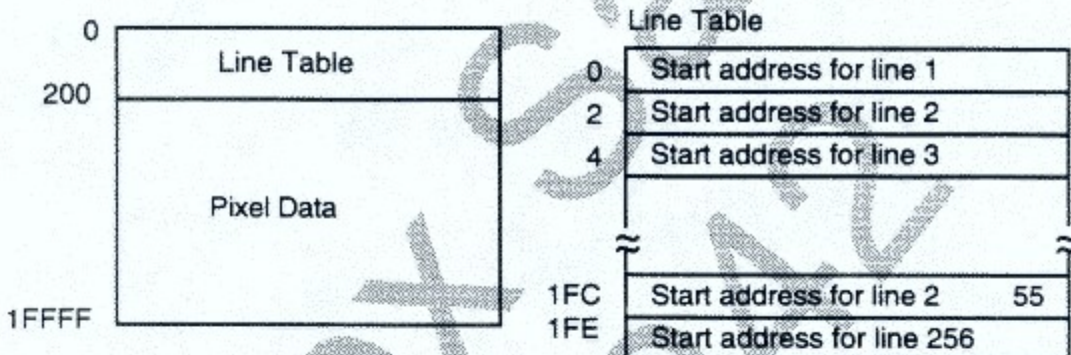

Note: One line is defined by 320 dots.

◆ Surface Shift Control

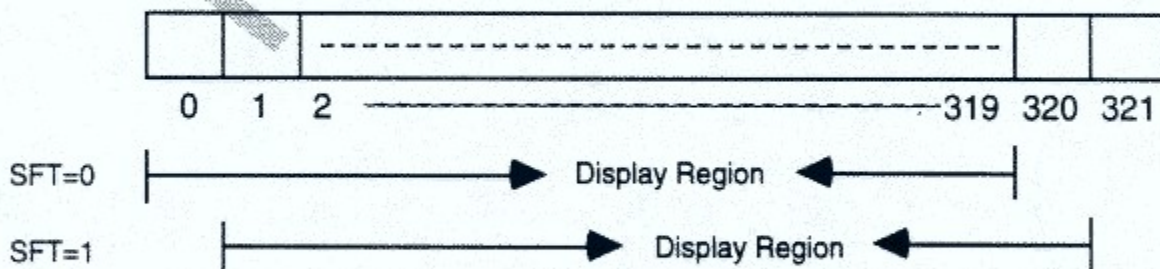

Because address data that is set in a line table is in word units, it can only change a table in 2 dot units when a packed pixel. Therefore, to change the display position by 1 dot units, use the SFT bit (when performing H scroll for example). Dot shifting can be done only in screen units.

◆ **Auto Fill**

This function fills the DRAM (Frame Buffer) with page (256 Word) units. Please be aware that fill can be done only inside a page.

Ex. 1) Start = \$0022A
 Length = \$E3
 Data = \$AA

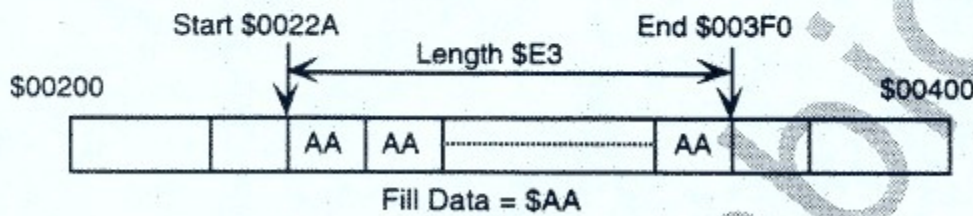

Ex. 2) Start = \$00280
 Length = \$E0
 Data = \$55

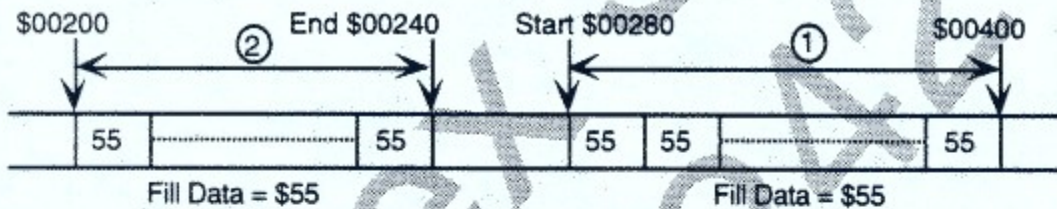

If a Length value is set that exceeds the page, as in example 2, then the address will return to the head of the page.

Auto Fill Address revises the values as shown below.

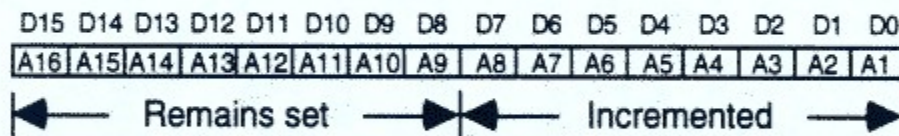

Fill time calculation formula $7 + 3 \times \text{Length (cyc)}$

NTSC Scyc = 1/23.01 [MHz] PAL Scyc = 1/22.8 [MHz]



Precautions Concerning VDP

- When accessing the palette RAM during the display interval (HBLK = 0 and VBLK = 0) in the packed pixel mode, there will be a wait until entering Blank.
- The internal circuit ignores the access of a CPU accessing VDP that does not have permission for VDP access by FS bit. Be particularly aware when reading that undefined data will be readout.
- The four areas that receive access control from the FM bit are the Frame Buffer, Over Write Image, VDP Register, and Palette RAM.
- The development board halts access of the VDP by the CPU that does not have permission from the FM bit to access the VDP.

Rex Sabio
242

Access Time Table (These may change depending on the development situation hereafter.)

Sclk = 23.01 MHz

Vclk = 7.67 MHz

◆ ROM Image Area

		Read / Write		
SH2	min. 5	Sclk wait		
	max. 15	Sclk wait	(14 Sclk wait when reading access of 68K that is in an interval)	
68K	min. 0	Vclk wait		
	max. 5	Vclk wait		

◆ Frame Buffer

		Read		Write	
SH2	min. 4	Sclk wait		1	Sclk wait
	max. 8	Sclk wait		8	Sclk wait
		Read / Write			
68K	min. 1	Vclk wait			
	max. 3	Vclk wait			

◆ SYS REG

		Read		Write	
SH2	1	Sclk wait		1	Sclk wait
68K	0	Vclk wait		0	Vclk wait

◆ VDP REG

		Read		Write	
SH2	4	Sclk wait		4	Sclk wait
68K	1	Vclk wait		0	Vclk wait

◆ Boot ROM

SH2	1	Sclk wait
-----	---	-----------

Precautions When Using SH2 ICE

The following restrictions apply until you are able to change to the latest ICE (about 6 months).

- All SH7604 E7000 V1.0 restrictions are in effect.
- SDRAM cannot be accessed by the cache through.
- Data cannot be properly transferred even when treating SDRAM in the DMA source and the destination in the SDRAM by DMA.
- With an Expansion Board:
 - SH ROM access has a minimum 6 clock wait (8 clock access)
 - SH VDP register has a minimum 5 clock wait (7 clock access)
- The current SH2 ICE cannot access the SDRAM with cache through. You must be careful when read/writing data by both master and slave since the cache can not be turned OFF. The SH2 final chip does not occur in the problem mentioned above.
- VDP REG and Palette have a minimum 5 clock Wait (7 Clock access)

Note: SH in this document refers to SH7604 (SH2).

Rex Sabio
242