

*Super*  
**MONACO GP**



**SEGA**



# Loading Instructions:

## Starting Up:

1. Make sure the power switch is OFF.
2. Insert the game cartridge in the Power Base (shown below) as described in your SEGA SYSTEM manual.
3. Turn the power switch ON. If nothing appears on the screen, turn the power switch OFF, remove the cartridge and try again.
4. At the title screen, press Button 1 or 2 to start the game.

**IMPORTANT:** Always make sure that the Power Base is turned OFF when inserting or removing your Mega Cartridge.

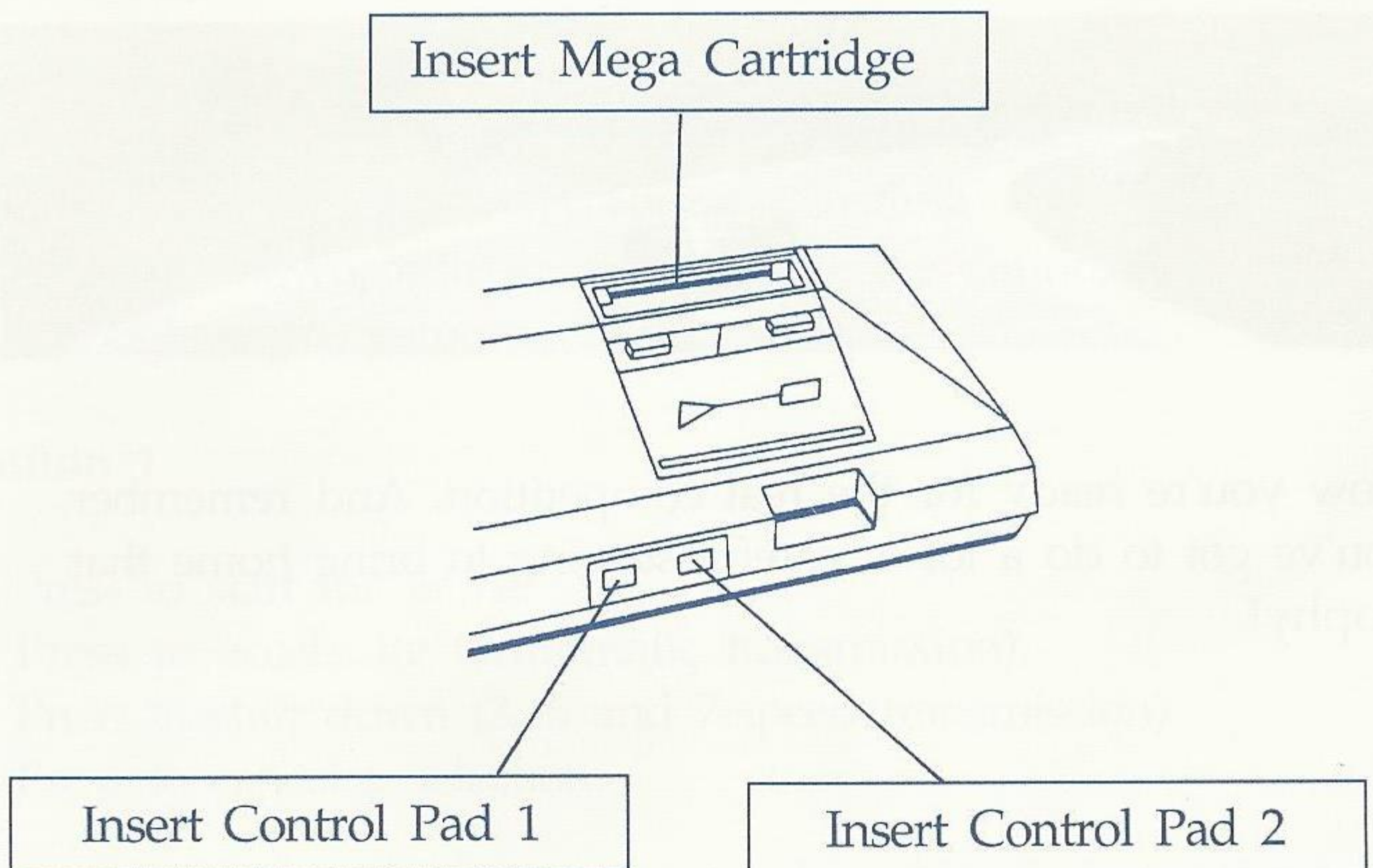

## Super Monaco GP™

If you are longing to experience the thrill of a real Grand Prix auto race, here's your chance. Super Monaco GP lets you race on many of the world's toughest courses against some of the most aggressive drivers.

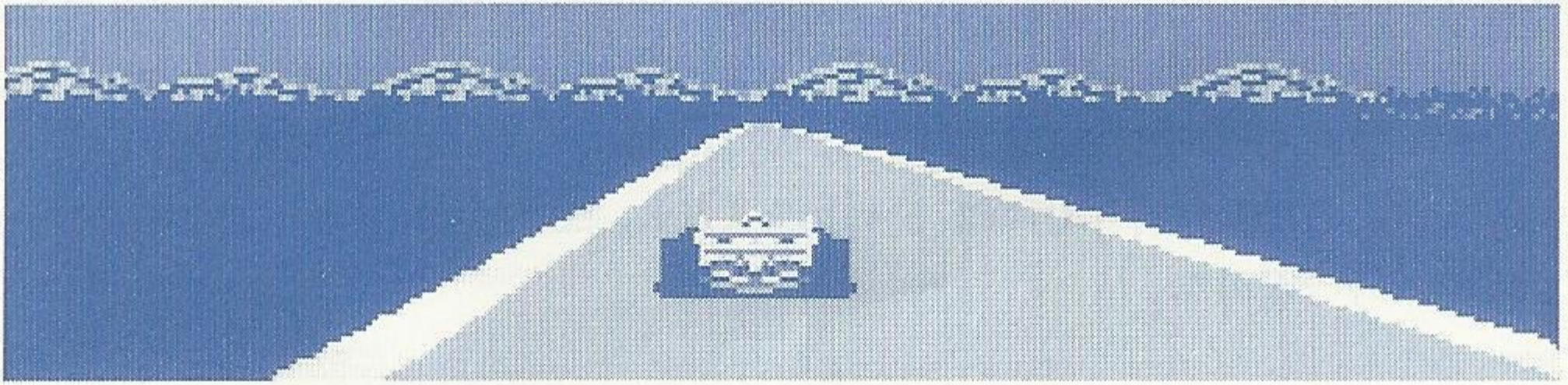

Begin by building your own machine. Your performance depends on how you assemble your vehicle. Choose your car's transmission, engine, wing and tires. Then get behind the wheel and take a trial lap around the course.

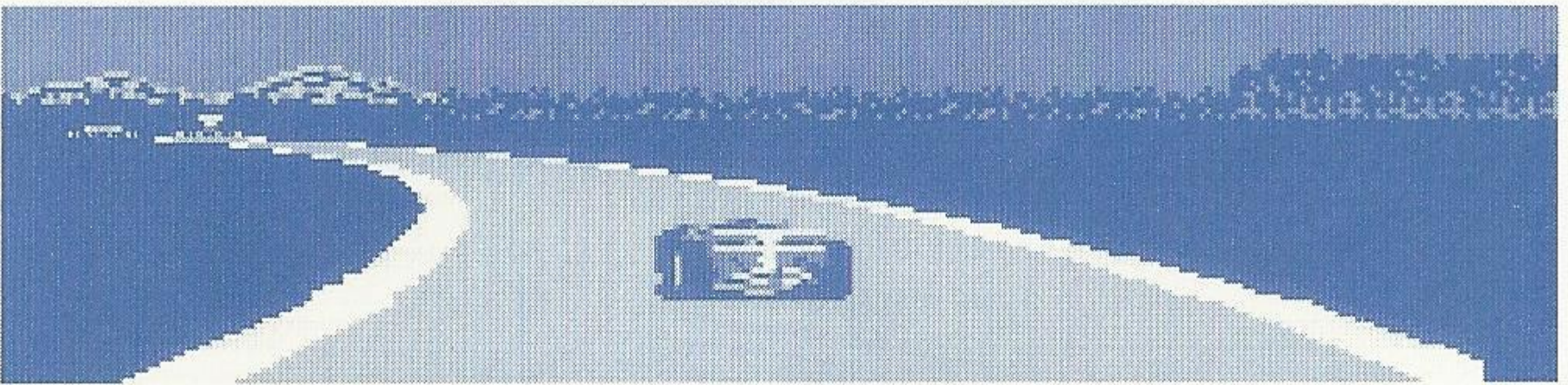

Now you're ready for the real competition. And remember, you've got to do a lot of careful steering to bring home that trophy!

# Take Control!

Super Monaco GP can be played by 1 or 2 players. Player 1 uses Control Pad 1 and Player 2 uses Control Pad 2. Learn how to use your Control Pad before starting play.

## Control Pad Buttons

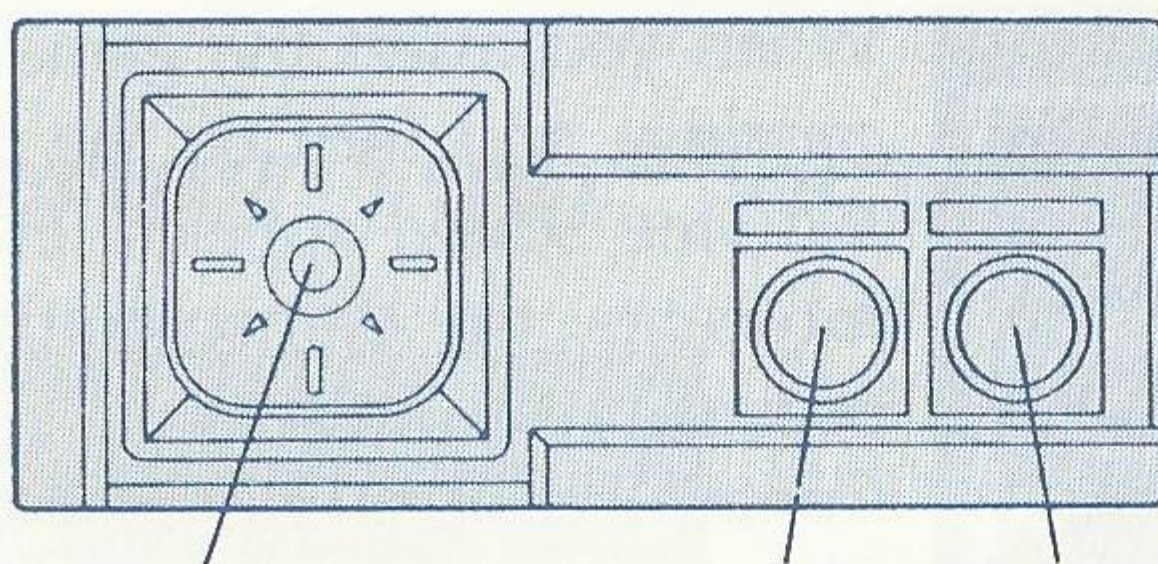

DIRECTIONAL  
BUTTON  
(D-Button)

BUTTON  
①

BUTTON  
②

### Directional Button (D-Button)

- Press left or right to steer your car in those directions.
- Press up, down, right or left to make the various selections throughout the game.

### Button 1

- Press to start the game.
- Press to accelerate (Automatic transmission).
- Press to shift down (3, 5 and 7-speed transmission).
- Press to cancel a selection.

## Button 2

- Press to start the game.
- Press to brake (Automatic transmission).
- Press to shift up (3, 5 and 7-speed transmission).
- Press to confirm a selection.

## Getting Started

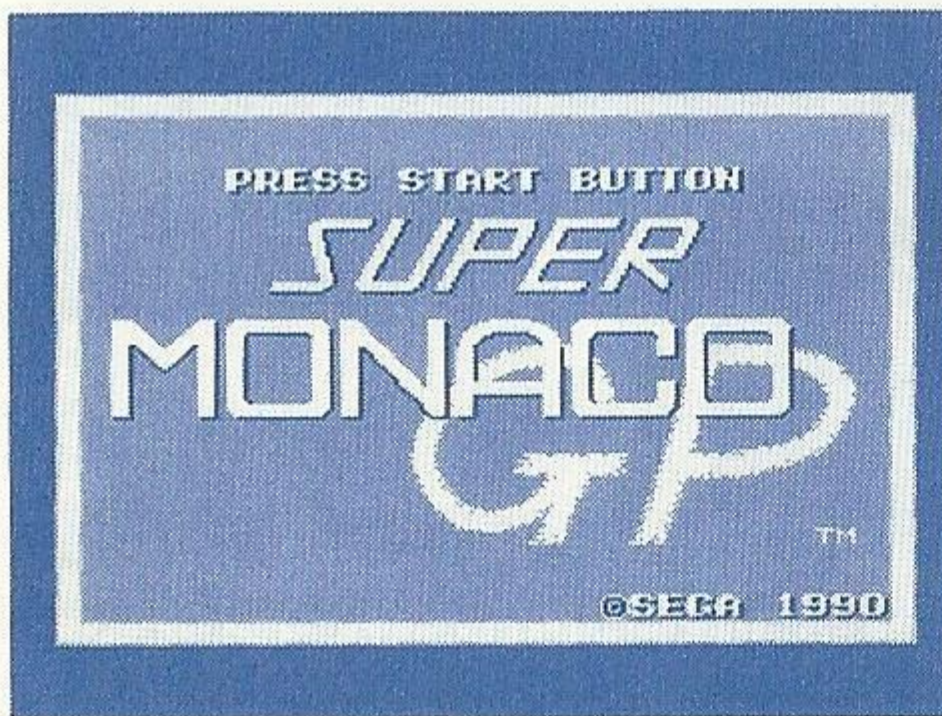

Title Screen

When you insert the game cartridge and turn on the power, the Title Screen appears. In a few moments, the demonstration begins. Press Button 1 or 2 on Control Pad 1 to return to the Title screen. Then press either button again to go on to the Player Selection screen.

On the Player Selection screen, press the D-Button to select 1 Player or 2 Players. Then press Button 1 or 2.



Player Selection Screen



Race Mode Screen

On the Race Mode screen, you can choose Grand Prix Mode or Vs. Battle Mode. Press the D-Button to mark your choice and then press Button 2. To return to the Player Selection screen, press Button 1.

## Entering Your Name



To enter your name, press the D-Button to select the letter you want and press Button 2. If you want to include a space, select the "space" under Z and press Button 2. To make corrections, press Button 1 to erase and then re-enter the correct letter. When

you're through, select END and press Button 2. Your name turns from white to blue. (If you fill up all 8 spaces, END is automatically selected.)

**Note:** Player 1 uses Control Pad 1 and Player 2 uses Control Pad 2 to enter names.

## Preparing for the Grand Prix

If you choose the Grand Prix Mode, the following screen appears after the Name Entry screen. Here you see a map of the course you're about to run and the best time for 1 lap

around the course. See if you can beat the best time.



Underneath the map is the game mode selection box. Press the D-Button to select Machine Set, Test Run or Grand Prix and then press Button 1 or 2.

## Machine Set

Here's your opportunity to assemble your vehicle. On each screen, press the D-Button to mark your choice and press Button 2. To return to the previous screen, press Button 1.

## Transmission

Select a transmission.

- **Automatic Transmission:** Compared to the manual transmissions, it's easier to handle.
- **Manual Transmission:** For beginners, it's probably a bit difficult to handle. But you can take better control of the speed.



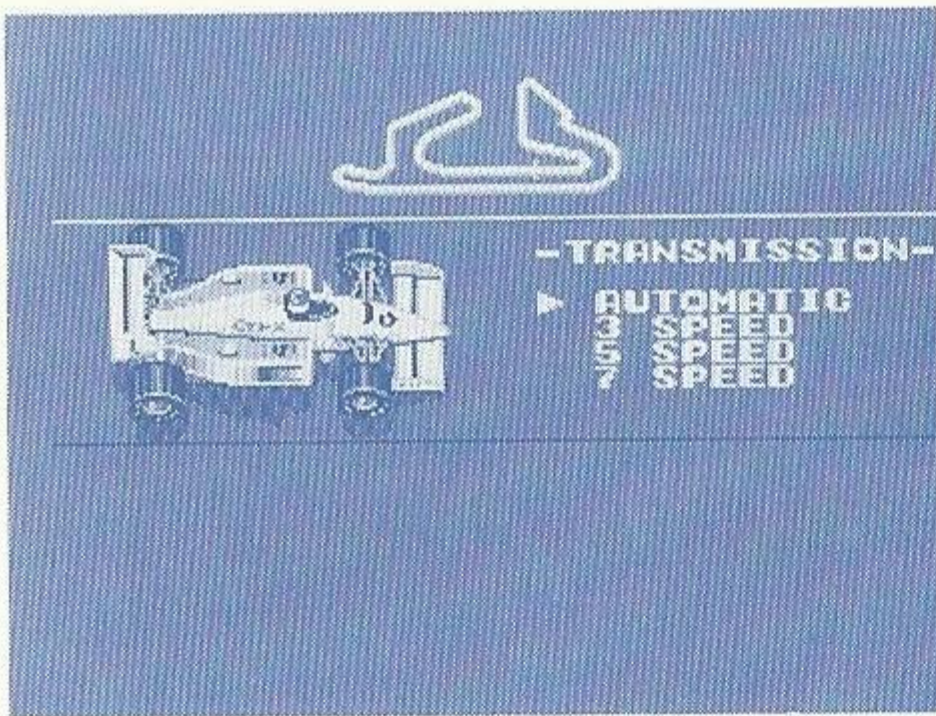

	Acceleration
3 Speed	Min
5 Speed	↕
7 Speed	Max

## Wing

Select a wing. The wing is an airfoil that is mounted on the rear of a racing car to improve the car's traction. The greater the traction, the faster the car goes. But carrying a heavy wing may give you problems when making turns.

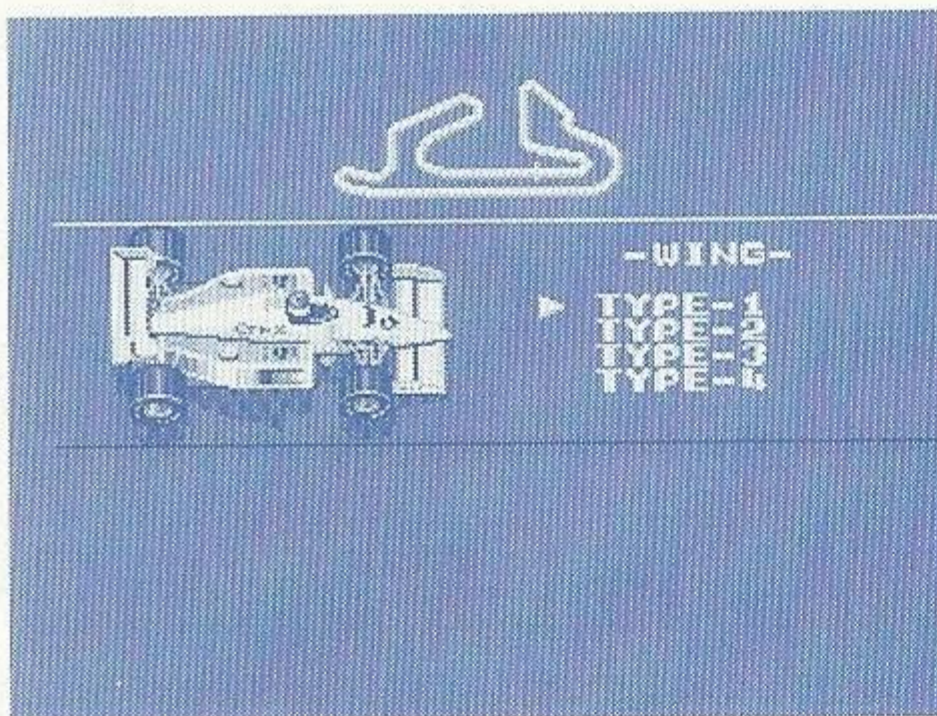

	Traction	Weight
Type-1	Max	Heavy
Type-2	↕	↕
Type-3	↕	↕
Type-4	Min	Light

## Engine

Select an engine.

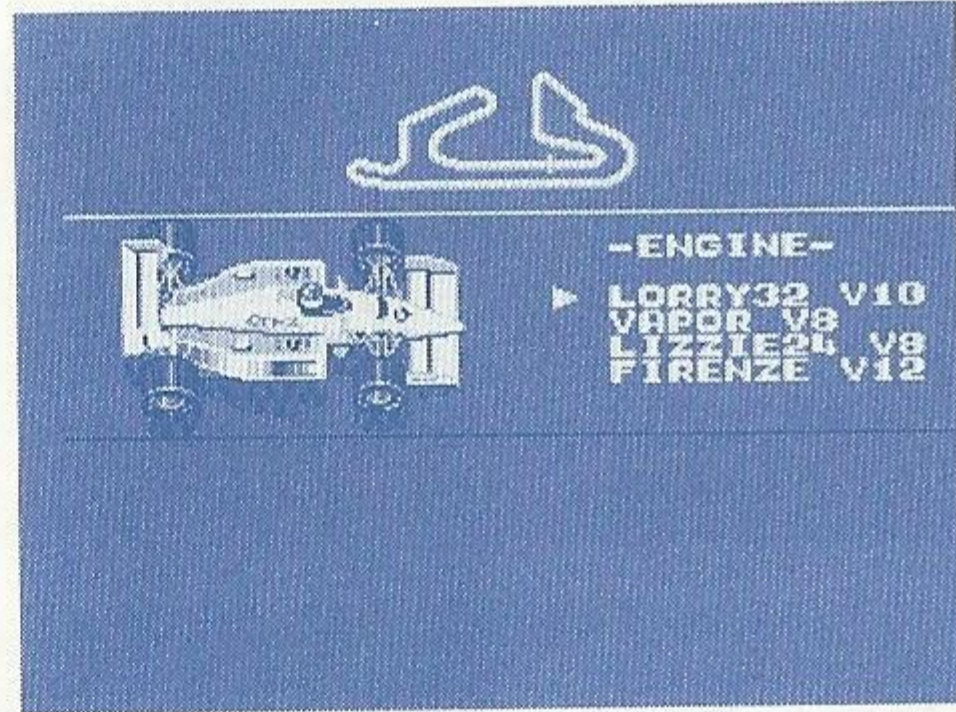



	Max Speed	Acceleration
Lorry32 V10	290 km/h	Maximum
Vapor V8	300 km/h	↕
Lizzie24 V8	310 km/h	
Firenze V12	320 km/h	Minimum

## Tires

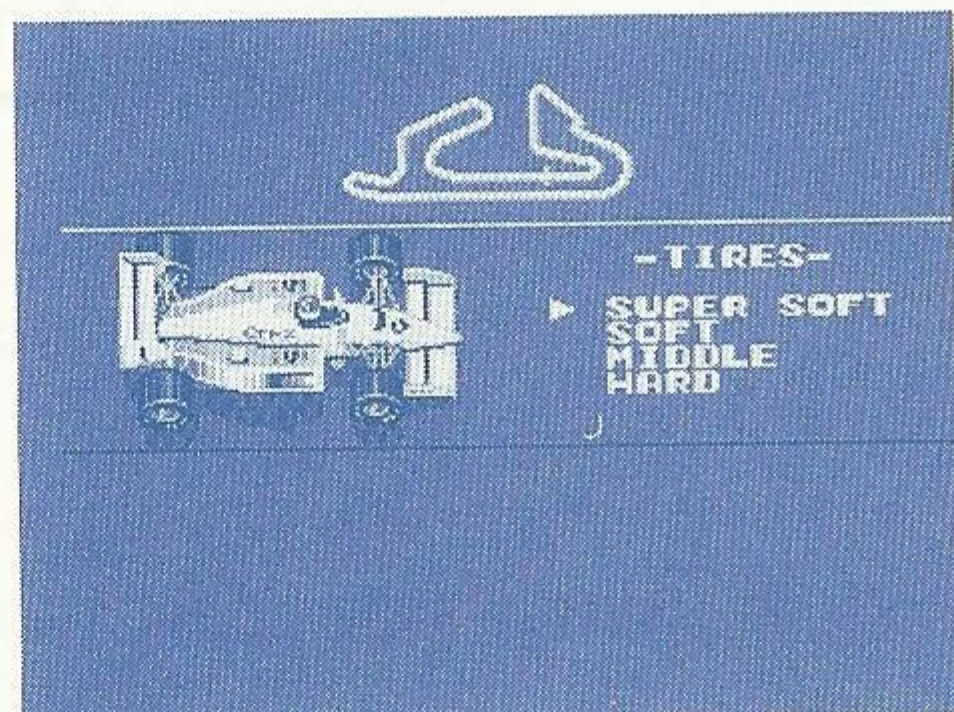
Select tires.



	Traction	Durability
Super Soft	Maximum	Minimum
Soft		
Middle		
Hard	Minimum	Maximum

The Race Preparation screen automatically reappears after you finish selecting parts for your vehicle.

## Test Run

When you select Test Run, you can test your vehicle and try out your driving skills. Who knows, you may need to reassemble your vehicle before you head out to the Grand Prix.

## Grand Prix

There is a total of 16 races in the Grand Prix mode. For each race, you are required to make 3 laps. If you play alone, the computer will be your main rival. If 2 people are playing, you compete against the other player. The computer controls the rest of the cars in the race.

## Grand Prix: Scoring

When the race is over, the Ranking screen appears. This screen shows where you rank and the points you earned.

- 1st Place: 9 points
- 2nd Place: 6 points
- 3rd Place: 4 points
- 4th Place: 3 points
- 5th Place: 2 points
- 6th Place: 1 point

-RANKING-		
	NAME	POINTS
1ST	COMPUTER	9
2ND	G. TURNER	6
3RD	E. TORNIO	4
4TH	G. CERRA	3
5TH	A. PIGOS	2
6TH	J. HERBIN	1
7TH	DDDDDDDD	

If you don't rank among the top 6 racers, you won't earn any points. To continue the game, you must rank among the top 10 racers. Otherwise, the game is over.

Press Button 1 or 2 to go on to the Points Ranking screen. This screen shows your overall ranking. Press Button 1 to view the bottom half of the Points Ranking Screen. Press Button 1 or 2 to exit the screen.

-POINTS RANKING-											
	ROUND										
NAME		1	2	3	4	5	6	7	8	9	10
1	COMPUTER	9									1111111
2	G. TURNER	6									
3	E. TORNIO	4									
4	G. CERRA	3									
5	A. PIGOS	2									
6	J. HERBIN	1									
7	E. BELINI	-									
8	K. HASE	-									
9	M. MOREAU	-									

## Vs. Battle

In the Vs. Battle mode, your only rival is the other player (or the computer). The course is randomly picked by the computer.



Lap Selection Screen

When you select Vs. Battle on the Race Mode screen, the Lap Selection screen appears. With the D-Button, select the number of laps you want to race and press Button 2. (To return to the Player Selection screen, press Button 1.)



Battle Selection Screen

On the Battle Selection screen, select the number of times you wish to compete, then press Button 2.

Enter your name on the Name Entry screen. (See Entering Your Name.)

## Preparing for the Battle

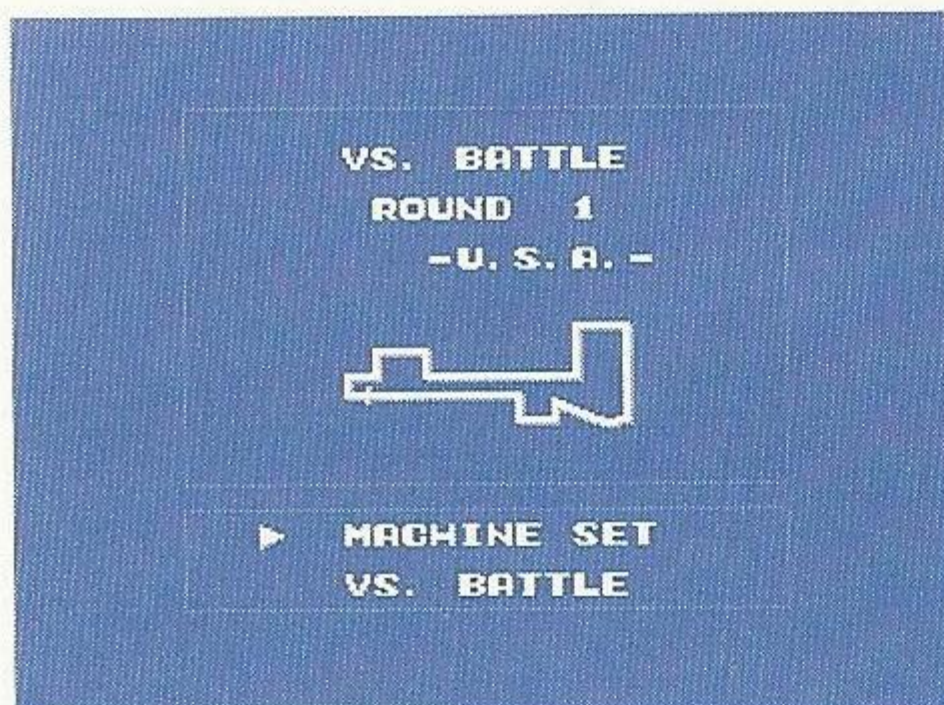

Now you see a map of the course you're about to run. Below the map is the game mode selection box. Press the D-Button to select Machine Set or Vs. Battle and then press Button 1 or 2.

## Machine Set

Select parts for your vehicle before you head out to the race.  
(See Machine Set.)

The race preparation screen automatically reappears after you finish selecting parts for your vehicle.

Select Vs. Battle with the D-Button and press Button 1 or 2 to start the game.

## Vs. Battle: Scoring

After the Vs. Battle race the following screen appears. This screen shows the results of the race. You must win more races than your opponent to win the battle.

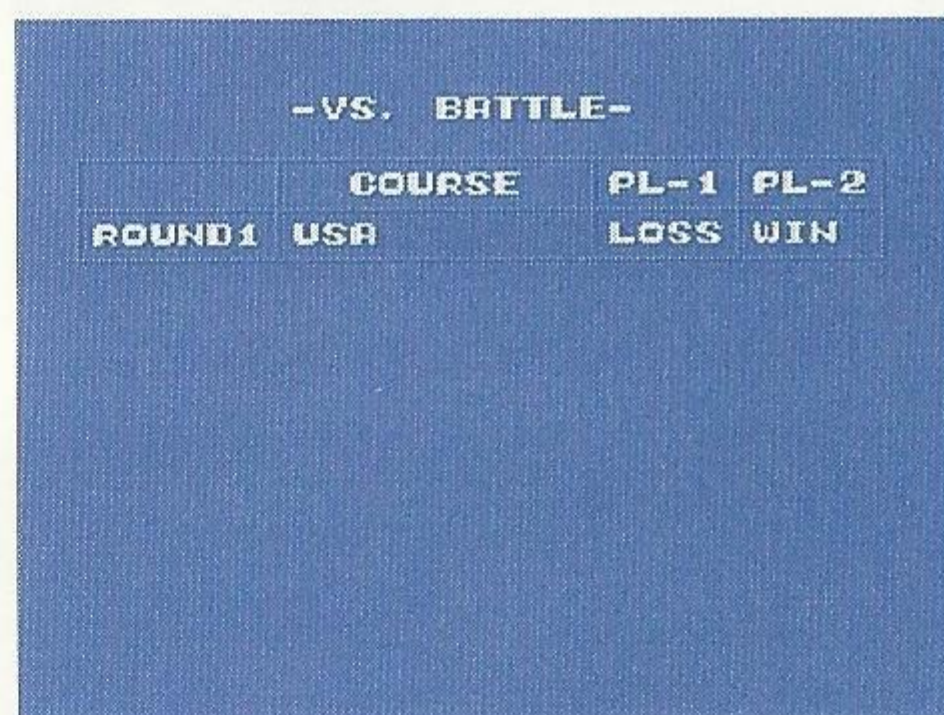

-VS. BATTLE-			
	COURSE	PL-1	PL-2
ROUND1	USA	LOSS	WIN

## What Your Screens Show

1. Map of the Course
2. Lap Time
3. Lap Counter
4. Player 1
5. Player 2
6. Your Present Ranking (In Grand Prix Mode only)
7. Type of Transmission
8. Speedometer

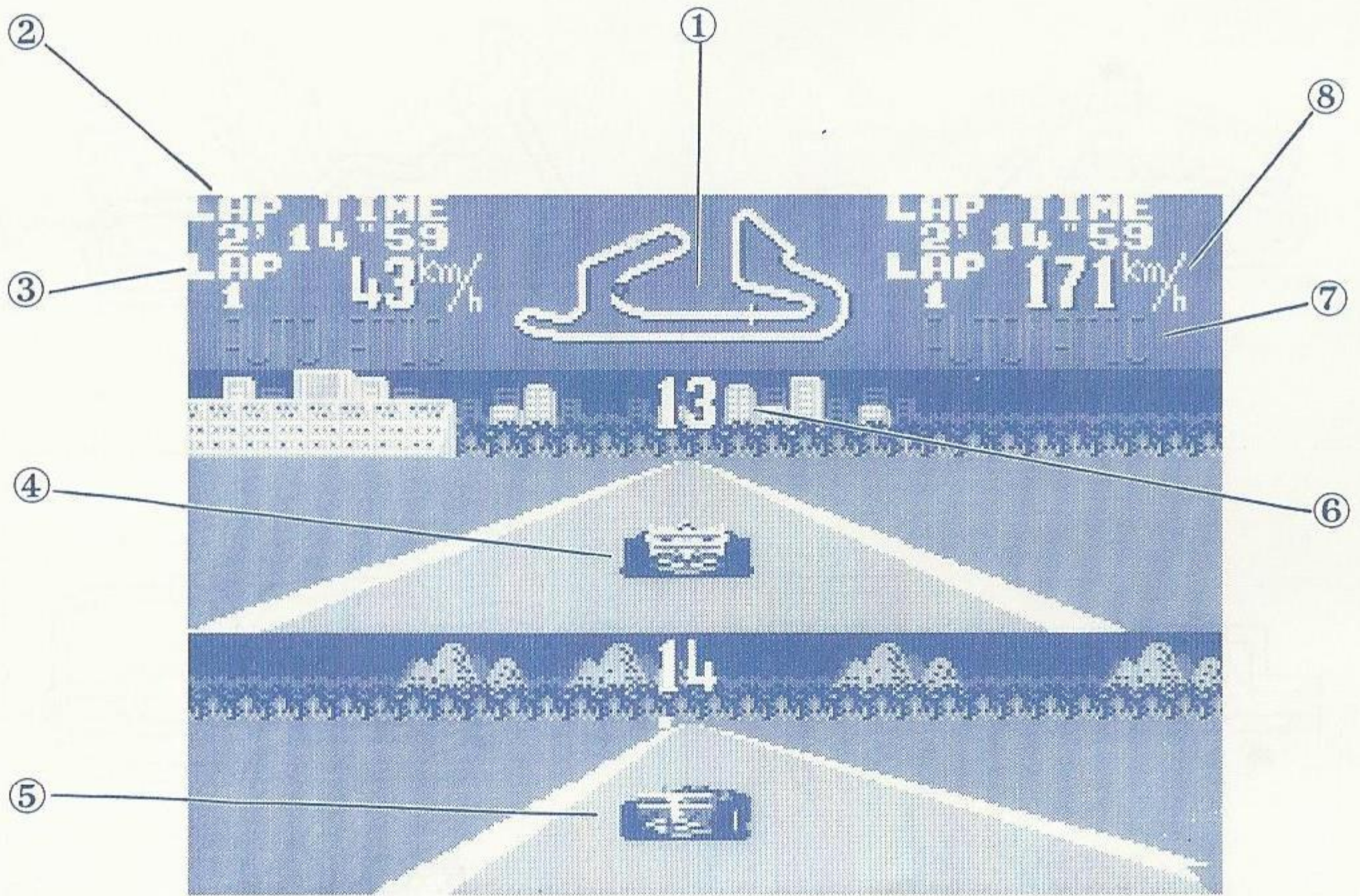

## The Courses

Here's a chance to study the 16 courses before you get behind the wheel.

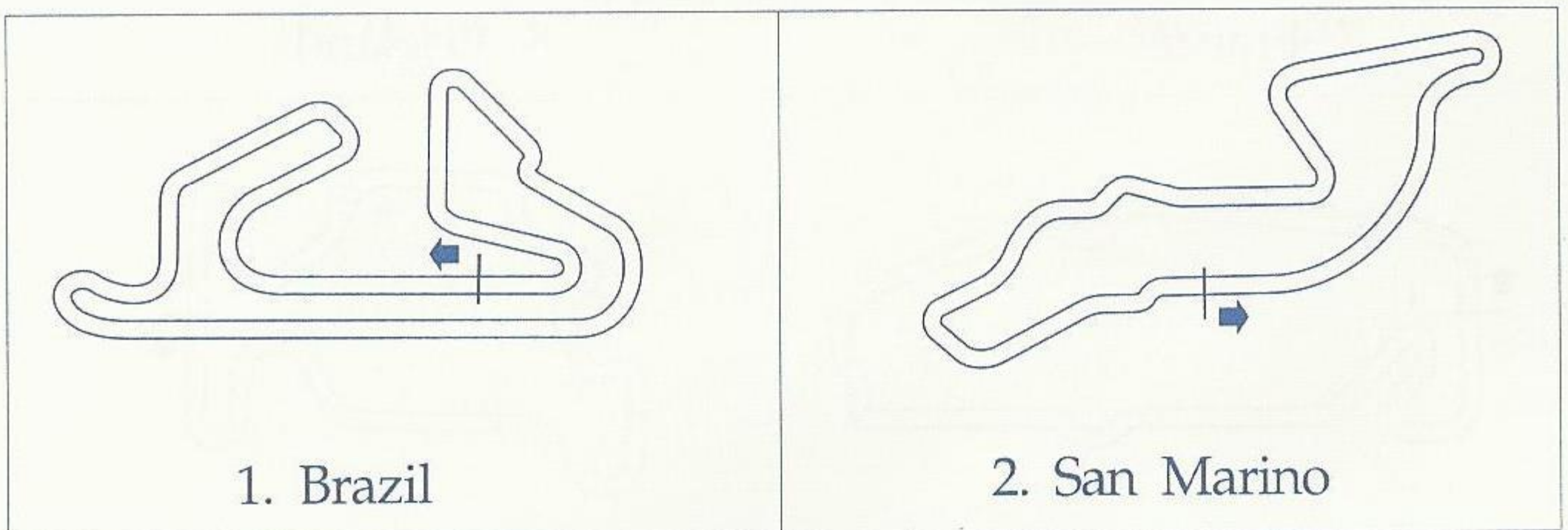

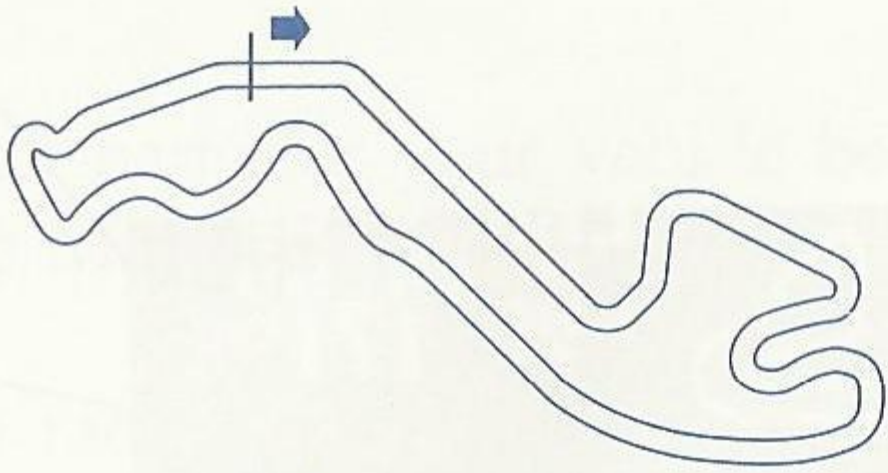

3. Monaco

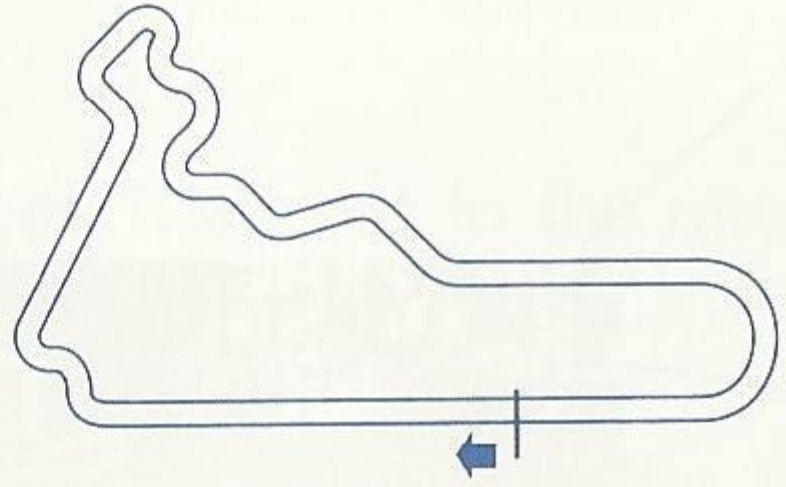

4. Mexico

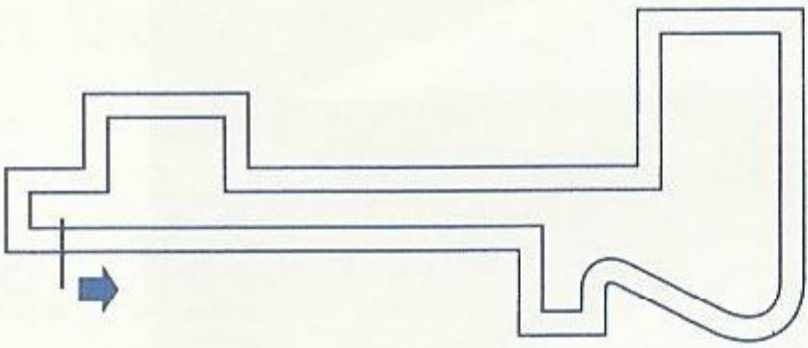

5. U.S.A

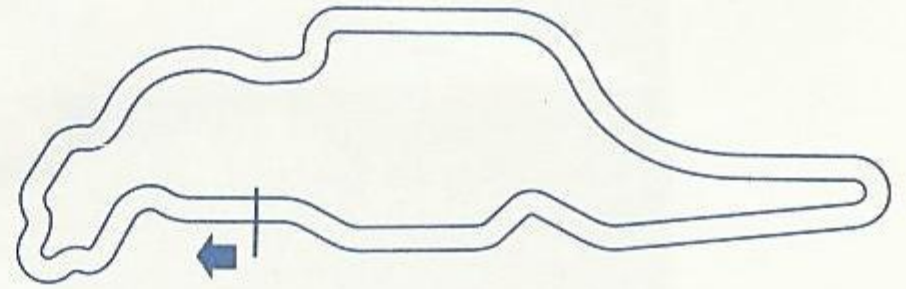

6. Canada

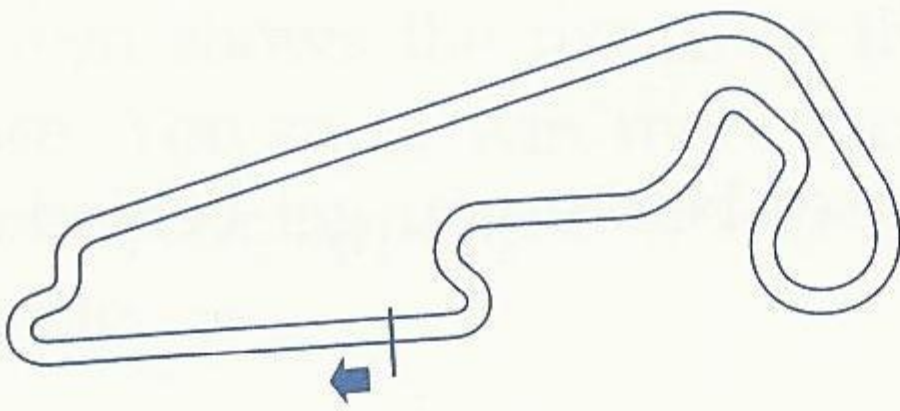

7. France

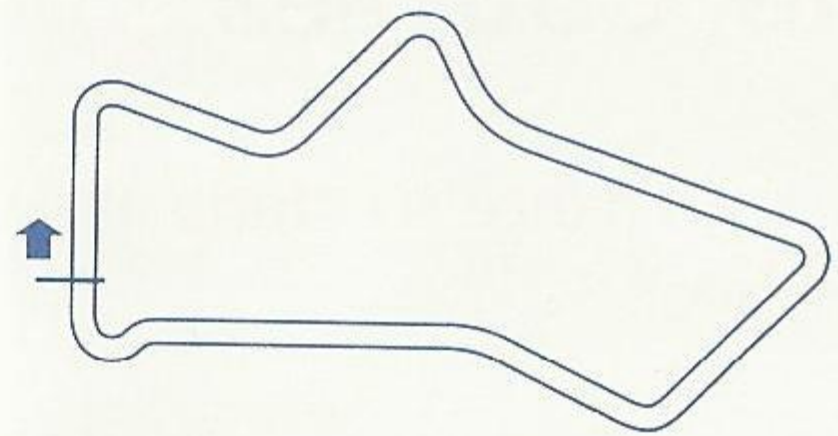

8. England

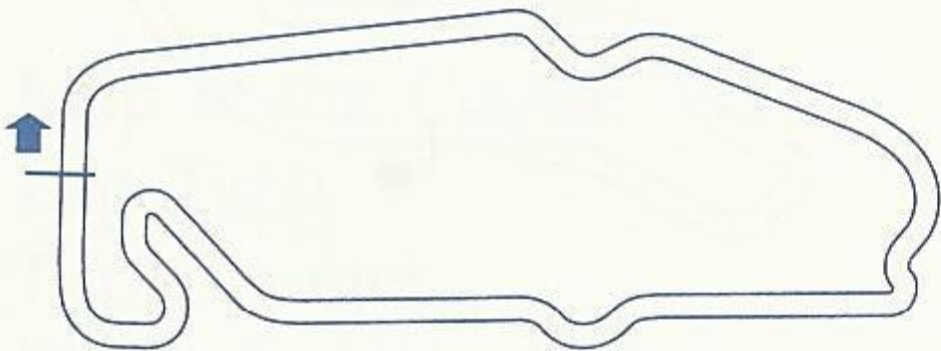

9. West Germany

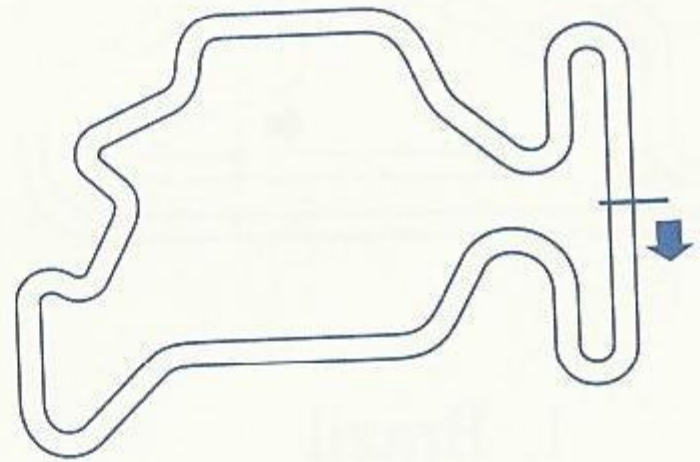

10. Hungary



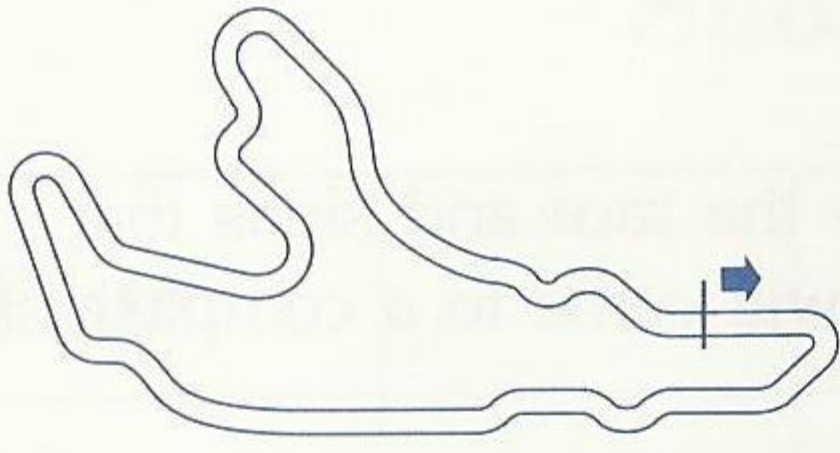

11. Belgium

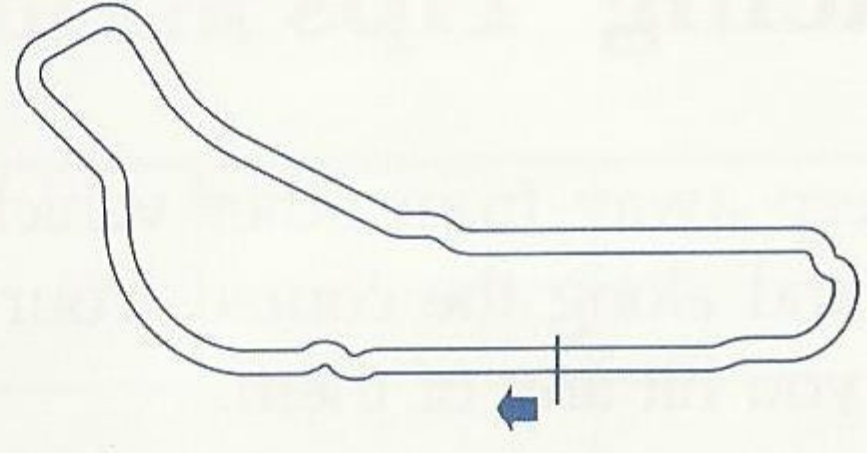

12. Italy

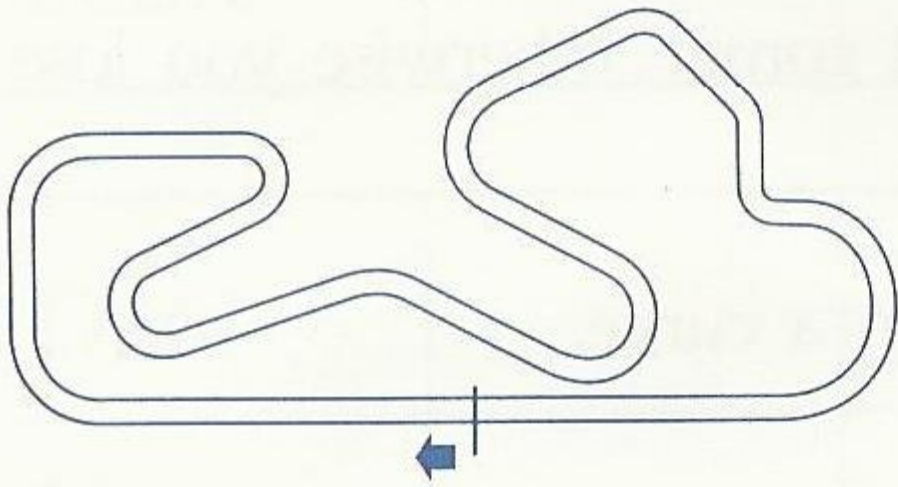

13. Portugal



14. Spain

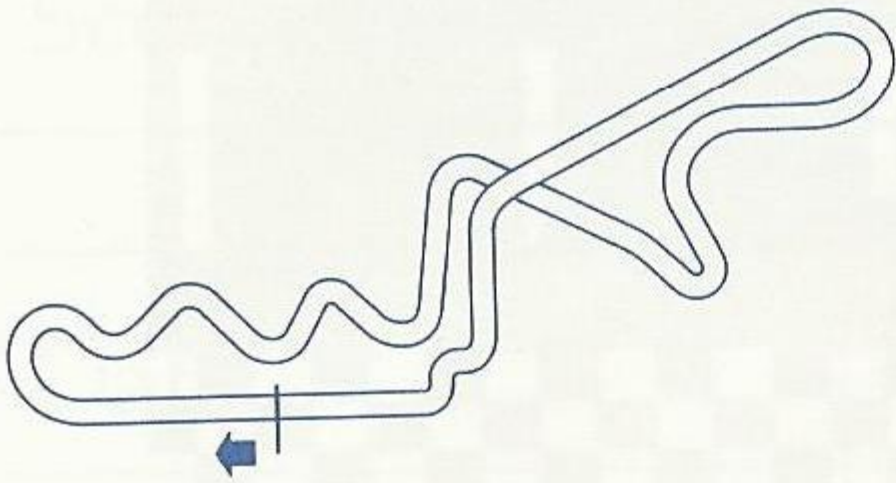

15. Japan

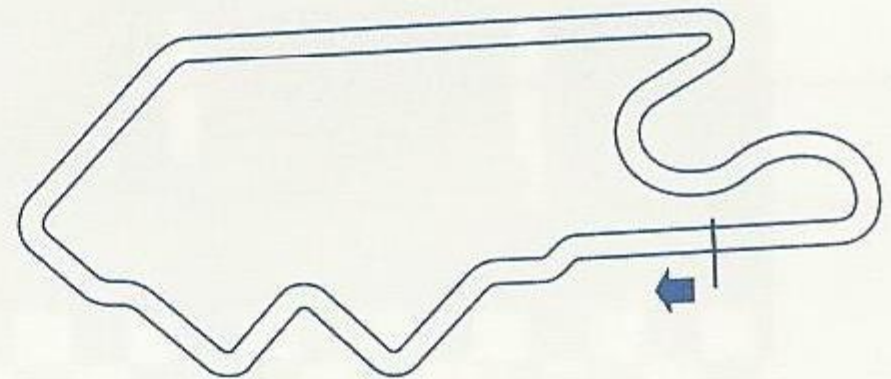

16. Australia

## Racing Tips

- Keep away from other vehicles in the race and signs that stand along the course. Your car will come to a complete stop if you hit any of them.
- Study your courses first and then build your vehicle.
- Slow down when making a tight corner, otherwise you lose control.
- Don't try to pass other vehicles on a curve.

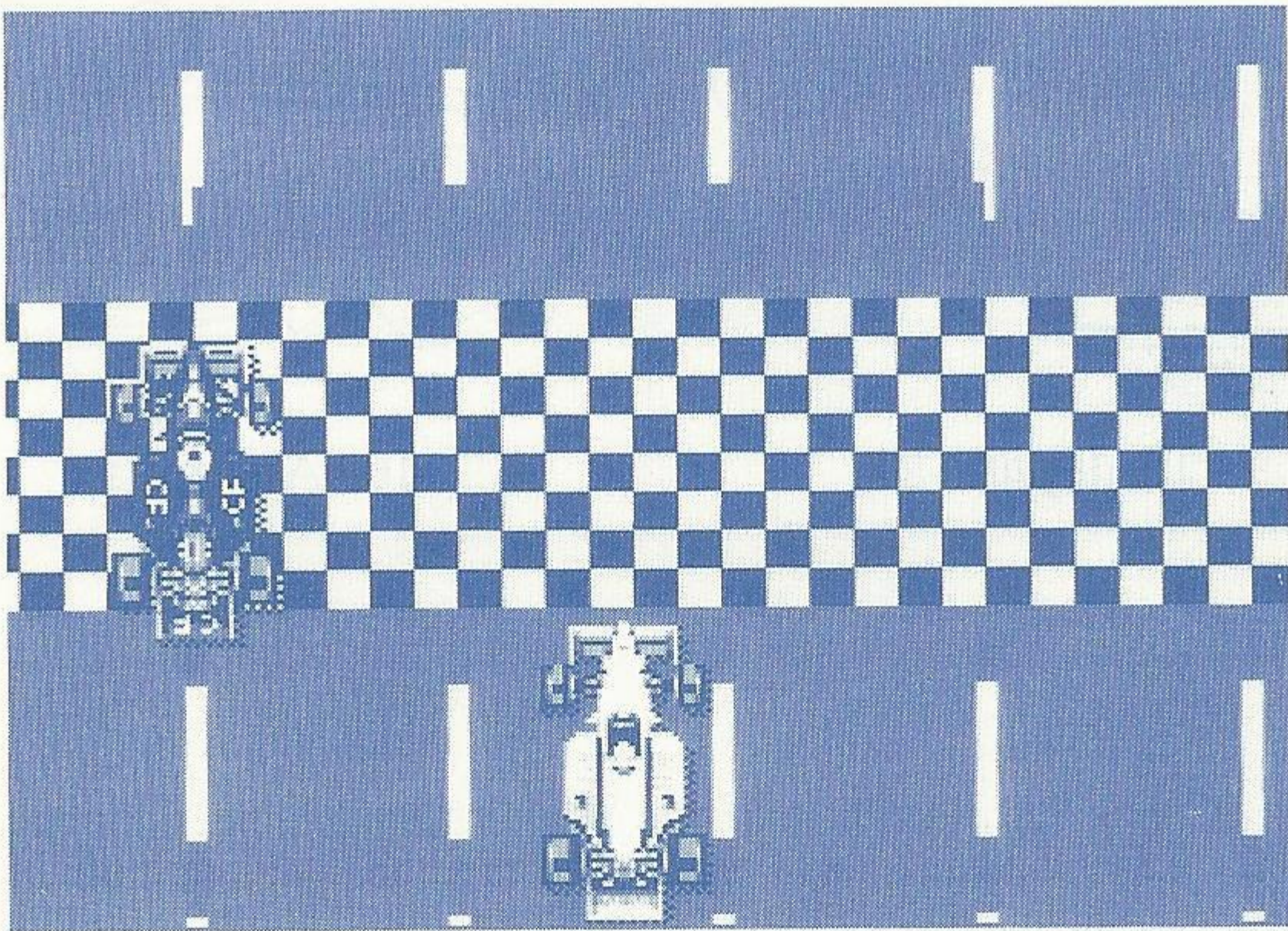

# Scorebook

Date				
Name				
Score				

Date				
Name				
Score				

Date				
Name				
Score				

Date				
Name				
Score				

# Scorebook

Date				
Name				
Score				

Date				
Name				
Score				

Date				
Name				
Score				

Date				
Name				
Score				

# Handling This Cartridge

- This Cartridge is intended exclusively for the Sega System™.
- Do not bend, crush or submerge in liquids.
- Do not leave in direct sunlight or near a radiator or other source of heat.
- Be sure to take an occasional recess during extended play.

## Warranty

Sega of America, Inc., warrants to the original consumer purchaser that this Cartridge shall be free from defects in material and workmanship for a period of 90 days from the date of purchase. If a defect covered by this warranty occurs during this 90-day warranty period, Sega will repair or replace the defective cartridge or component part, at its option, free of charge.

This warranty does not apply if the defects have been caused by negligence, accident, unreasonable use, modification, tampering, or any other causes not related to defective materials or workmanship.

To receive fast, reliable warranty service, call the Sega Consumer Service Department at the following number:

**1-800-USA-SEGA**

Our Consumer Service Department is in operation from 6:00 a.m. to 9:00 p.m. (Pacific Time), Monday through Friday and from 8:00 a.m. to 6:00 p.m. (Pacific Time), Saturday and Sunday. **DO NOT RETURN YOUR CARTRIDGE TO YOUR RETAIL SELLER.** Return cartridge to Sega Consumer Service. Please call first for further information.

If the Sega technician is unable to solve the problem by phone, we will provide you with instructions on returning your defective cartridge to us. The cost of returning the cartridge to Sega's Service Center shall be paid by the purchaser.

## Repairs After Expiration of Warranty

If your Cartridge requires repairs after termination of the 90-day warranty period, you may contact the Sega Consumer Service Department at the number listed above. If the technician is unable to solve the problem by phone, he will advise you of the estimated cost of repair. If you elect to have the repair done, you will need to return the defective merchandise, freight prepaid and insured against loss or damage, to Sega's Service Center with an enclosed check or money order payable to Sega of America, Inc. for the amount of the cost estimate provided to you by the technician. If, after inspection, it is determined that your cartridge cannot be repaired, it will be returned to you and your payment will be refunded.

## Limitations on Warranty

Any applicable implied warranties, including warranties of merchantability and fitness for a particular purpose, are hereby limited to ninety days from the date of purchase and are subject to the conditions set forth herein. In no event shall Sega of America, Inc., be liable for consequential or incidental damages resulting from the breach of any express or implied warranties.

The provisions of this warranty are valid in the United States only. Some states do not allow limitations on how long an implied warranty lasts, or exclusion of consequential or incidental damages, so the above limitation or exclusion may not apply to you. This warranty provides you with specific legal rights. You may have other rights which vary from state to state.

---



©1990 Sega of America, Inc.

Sega of America, Inc. P.O. Box 2167, South San Francisco, CA 94080

Printed in Japan