

MAGFORCE™ RACING

SEGA®

CRAVE+
ENTERTAINMENT

EVERYONE
®
E
CONTENT RATED BY
ESRB

T-40208N

WARNINGS Read Before Using Your Sega Dreamcast Video Game System

CAUTION

Anyone who uses the Sega Dreamcast should read the operating manual for the software and console before operating them. A responsible adult should read these manuals together with any minors who will use the Sega Dreamcast before the minor uses it.

HEALTH AND EPILEPSY WARNING

Some small number of people are susceptible to epileptic seizures or loss of consciousness when exposed to certain flashing lights or light patterns that they encounter in everyday life, such as those in certain television images or video games. These seizures or loss of consciousness may occur even if the person has never had an epileptic seizure.

If you or anyone in your family has ever had symptoms related to epilepsy when exposed to flashing lights, consult your doctor prior to using Sega Dreamcast.

In all cases, parents should monitor the use of video games by their children. If any player experiences dizziness, blurred vision, eye or muscle twitches, loss of consciousness, disorientation, any involuntary movement or convulsion, **IMMEDIATELY DISCONTINUE USE AND CONSULT YOUR DOCTOR BEFORE RESUMING PLAY.**

To reduce the possibility of such symptoms, the operator must follow these safety precautions at all times when using Sega Dreamcast:

- Sit a minimum of 6.5 feet away from the television screen. This should be as far as the length of the controller cable.
- Do not play if you are tired or have not had much sleep.
- Make sure that the room in which you are playing has all the lights on and is well lit.
- Stop playing video games for at least ten to twenty minutes per hour. This will rest your eyes, neck, arms and fingers so that you can continue comfortably playing the game in the future.

OPERATING PRECAUTIONS

To prevent personal injury, property damage or malfunction:

- Before removing disc, be sure it has stopped spinning.
- The Sega Dreamcast GD-ROM disc is intended for use exclusively on the Sega Dreamcast video game system. Do not use this disc in anything other than a Sega Dreamcast console, especially not in a CD player.
- Do not allow fingerprints or dirt on either side of the disc.
- Avoid bending the disc. Do not touch, smudge or scratch its surface.
- Do not modify or enlarge the center hole of the disc or use a disc that is cracked, modified or repaired with adhesive tape.
- Do not write on or apply anything to either side of the disc.
- Store the disc in its original case and do not expose it to high temperature and humidity.
- Do not leave the disc in direct sunlight or near a radiator or other source of heat.
- Use lens cleaner and a soft dry cloth to clean disc, wiping gently from the center to the edge. Never use chemicals such as benzene and paint thinner to clean disc.

PROJECTION TELEVISION WARNING

Still pictures or images may cause permanent picture tube damage or mark the phosphor of the CRT. Avoid repeated or extended use of video games on large-screen projection televisions.

SEGA DREAMCAST VIDEO GAME USE

This GD-ROM can only be used with the Sega Dreamcast video game system. Do not attempt to play this GD-ROM on any other CD player; doing so may damage the headphones and/or speakers. This game is licensed for home play on the Sega Dreamcast video game system only. Unauthorized copying, reproduction, rental, public performance of this game is a violation of applicable laws. The characters and events portrayed in this game are purely fictional. Any similarity to other persons, living or dead, is purely coincidental.

CONTENTS

INTRODUCTION	2
CONTROLLER LAYOUT	4
HOW TO PLAY	6
STARTING THE GAME	8
POWER-UPS	14
MULTIPLAYER	17
CREDITS/ACKNOWLEDGMENTS	18

INTRODUCTION

As gasoline supplies dwindled and the simple act of driving threatened to become a luxury, the world's engineers were pressed into action to come up with an alternative fuel solution that would sustain humanity's desire for mobility. What the best minds in physics came up with was the concept of **MAGNETO-KINETIC (MK) DRIVING**—technology that would replace the loud growl of the gas-powered, internal combustion engine with the subtle hum of an electromagnetic power plant. Subsequently, mile after mile of rough blacktop roadways had to be replaced with the cold, smooth metal surface required for MK-based transit.

But driving hasn't just provided mankind with the utility of getting from place to place. It also offers sport, creating a brand of athlete that jockeyed metal machines over roadways at an insane pace. Racers need to balance the various aspects—**PRECISE NAVIGATION, HIGH SPEEDS AND FUEL CONSERVATION**, among others—in order to collect the spoils of a driving victory.

It's only natural, then, that as the clumsy gasoline-powered transportation gave way to efficient MK travel, the traditional race-car driver would give way to the steely nerve of the MK league racer. Speeds increased, the threat of death became more intense and the act of racing required the mastery of physics as tracks were designed to not only push **MIND-NUMBING SPEEDS** but also provide **GRAVITY-DEFYING CHALLENGES**. Where banked tracks helped gas-powered racers

keep four wheels on the course during a race, MK vehicles were equipped with powerful magnets that could lock a vehicle onto the track at steep angles—or even upside-down—while maintaining incredible speeds. And when league officials realized that there was **NO LIMIT** to where an MK vehicle could go, course designs gradually became more and more outrageous; featuring **CORKSCREWS, TUNNELS AND REFUEL POWER-UPS** in places that were seemingly impossible to reach.

Finally, as if the public's desire for race thrills was unsatisfied, race rules were relaxed to allow weapons to be mounted on the MK league's sleek Tripod craft. Now, in addition to the rigorous pace and insane track layouts, the MK pilot had to battle against the threat of **LASER FIRE, LAND MINES AND HOMING MISSILES** in order to get to the finish line.

MagForce Racing puts you in the MK league against the cream of the crop. Can you master the elements and surpass the challenges that MK racing puts in front of you? Surpass the offensive and defensive skills of your foes while navigating the increasing difficulty of the many courses scattered across the galaxy, and you will climb to the podium to collect the spoils of victory.

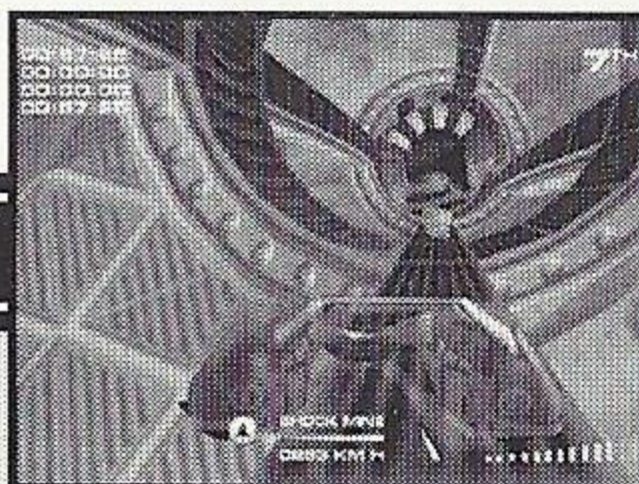
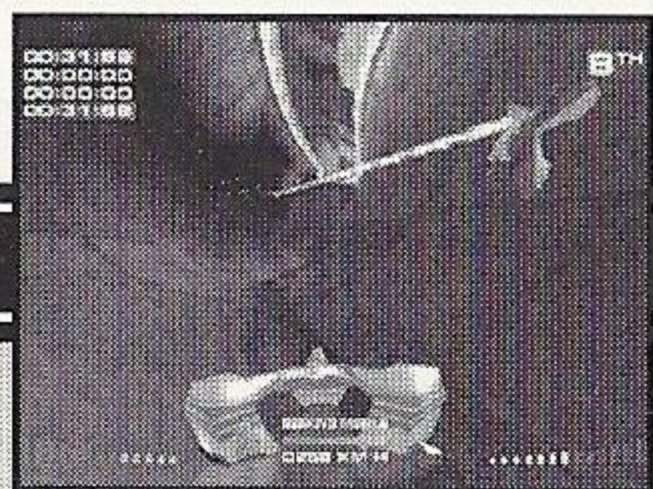

CONTROLLER LAYOUT

This game software is for 1 to 4 players. The 2, 3 and 4 player game requires additional controllers (sold separately). Before powering on your Sega Dreamcast, please connect a controller or other compatible peripheral to its controller port (operation with incompatible controllers is not guaranteed). Pressing the Start Button while holding down the A, B, X, and Y Buttons will reset the game, returning you to the title screen.

Standard Controller

SEGA DREAMCAST CONTROLLER

Overhead View

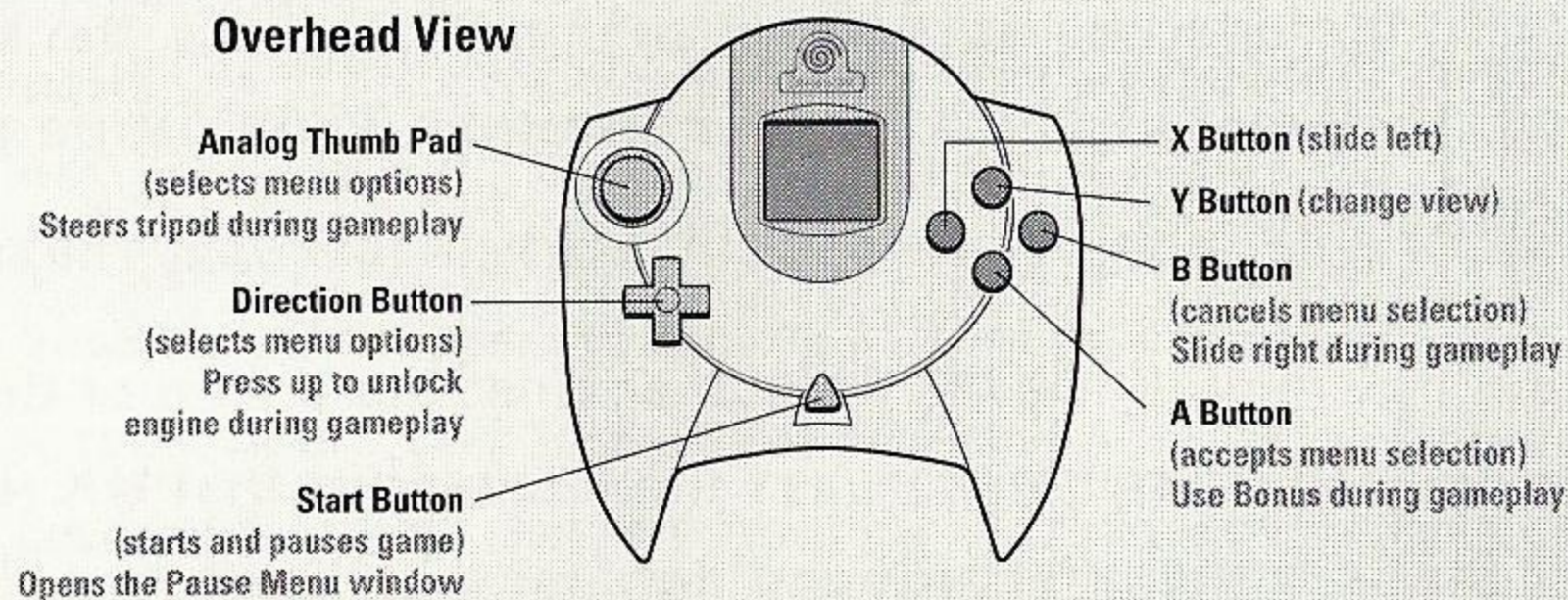

Forward View

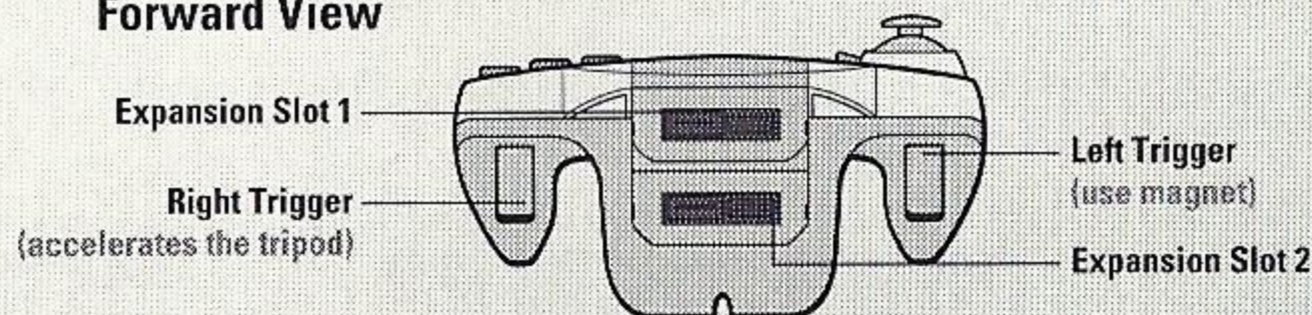

All settings listed here are default settings. You can make your own controller settings from the Options Mode (see page 13). When powering up the Console, do not press the Analog Thumb Pad or the Left/Right Triggers. Doing so prevents proper calibration of the controls, and they may operate improperly as a result.

Steering Wheel

RACE CONTROLLER

Front View

- Button
(moves down to select menus)
Slide left during gameplay

B Button
(cancels menu selection)
Use magnet during gameplay

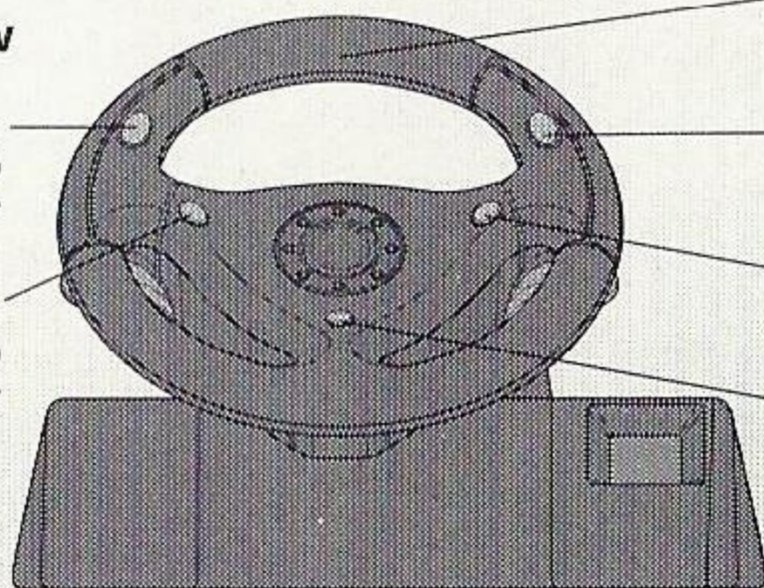

Steering Wheel
(moves left/right to select menus)
Steers tripod during gameplay

+ Button
(moves up to select menus)
Slide right during gameplay

A Button
(accepts menu selection)
Use bonus during gameplay

Start Button
(pauses game)
Opens the pause menu window

Rear View

R Trigger
(accelerate)

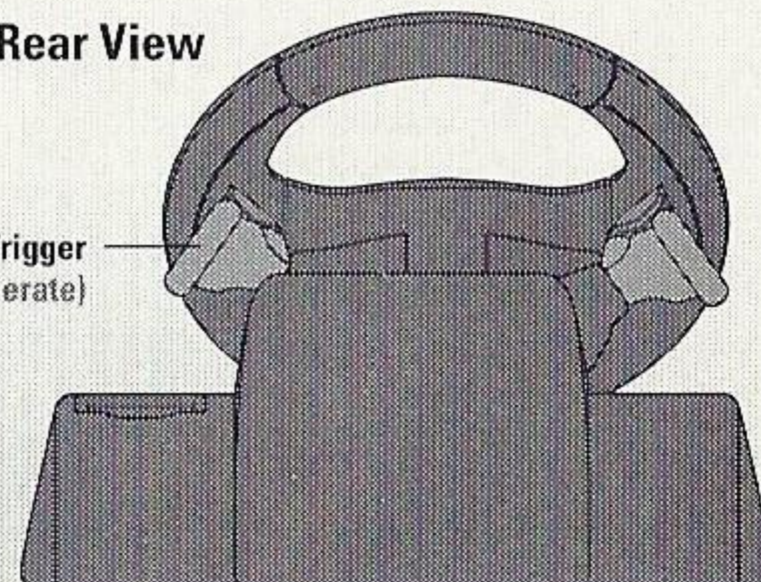

IMPORTANT: Do not manipulate the steering wheel or L/R Triggers when turning on the Sega Dreamcast. Failing to observe this warning will result in improper position adjustments and will cause the console to malfunction. If the console malfunctions, turn it off and then back on without manipulating the steering wheel or R/L Triggers. Pressing the Start Button while holding down the A, B, +, and - Buttons will reset the game, returning you to the title screen.

Jump Pack

SEGA DREAMCAST JUMP PACK™

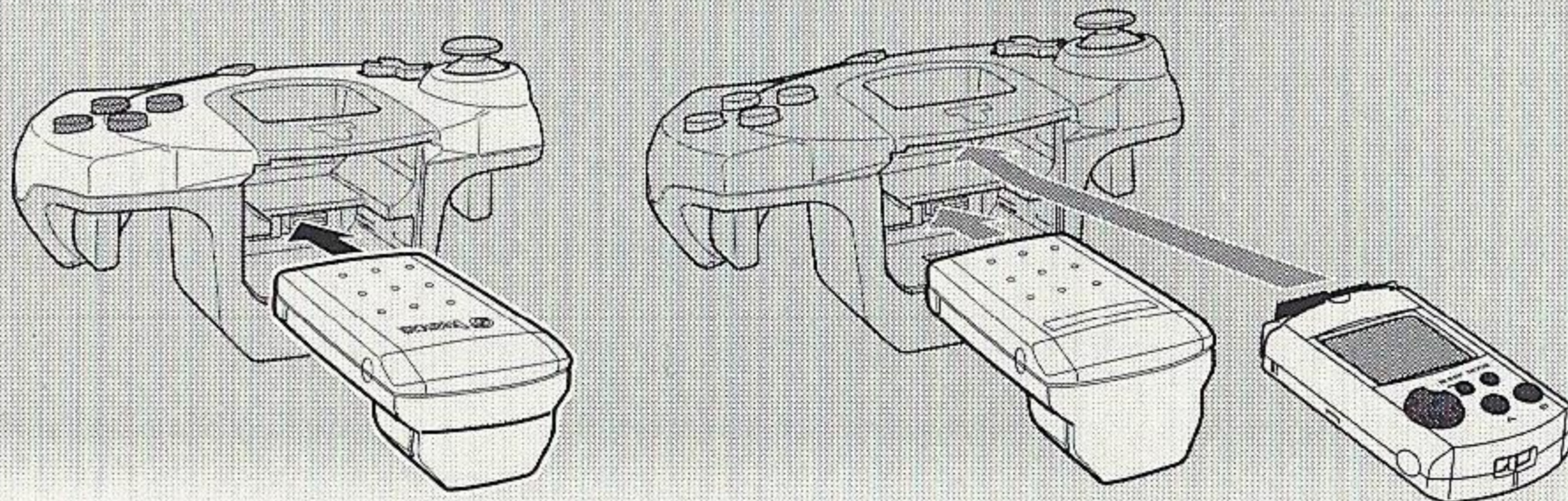

Always use expansion Slot 2 when using the Jump Pack with the Sega Dreamcast Controller. If the Jump Pack is inserted in Slot 1, it will not connect properly with the controller, and it may fall out during gameplay or operate incorrectly.

HOW TO PLAY

After picking the Tripod you want to race and selecting the game options (see “Starting the Game”), you’ll be placed at the starting line. When the start light and signal indicate the race’s beginning, accelerate from the line and navigate the course as quickly as possible, avoiding walls, your opponents’ vehicles and their weapons that will slow your Tripod. Simply be the first to cross the finish line after the three laps that make up a race, and you’ll be declared the winner. Easy, right?

Winning one race may feel like quite an accomplishment, but realize that there are four “classes” of MK racing. You have to be victorious in all of the races in a class before you can proceed to the next class. With each successive class, you are offered a more capable Tripod to pilot—but you’ll need that power to take on the improved abilities of your opponents and the increased difficulty of the tracks.

Mastering the twists and turns of an MK race at high speed is only one aspect of successful piloting. There’s also the need to navigate through the various power-ups that are strewn throughout the track. To triumph, MK pilots must decide, while maintaining the vehicle’s high speed, which power-up to grab: energy for faster driving speed, a weapon that will impede the opposing drivers or magnet power that will keep the Tripod on the track through difficult portions of the course.

Indeed, the final component needed to be a prosperous MK league racer is mastery of the magnet. There are times in a course when the track will turn upside-down or an

alternative path will reveal itself—paths that can only be navigated by activating the magnet that holds the Tripod on the track. Having the magnet power level filled is necessary for those occasions.

A level indicator in the bottom right-center of the screen will show you where the top of your tripod is in relationship to the track. If the arrow is pointing up, you are driving as you normally would. But if the arrow is pointing down, you are hanging from the ceiling and, with gravity pulling you down, you will need to use the magnet. If the magnet power level is empty and you attempt to use it, the tripod will use emergency backup power resulting in severely reduced speed.

Note that you must win all of the races in a class with the same Tripod in order to progress to the next class. Only MK pilots who successfully complete all of the league races with each of the four types of Tripod can group themselves among the most accomplished MK racers.

To pause the game while racing, press the Start Button. A menu will give you the option to "Continue" racing, "Quit" the race and return to the main menu or "Restart" the race. Use the Direction Button or Analog Thumb Pad to highlight the option and press the A Button to confirm.

Hint: To unlock the engine, press up on the Direction Button. This will disable the accelerator and will cause you to slide, but you will be able to rotate your tripod much quicker and shoot opponents behind you.

STARTING THE GAME

After loading the MagForce Racing disc and powering up the Sega Dreamcast, you'll find yourself at the main menu. If you have a VMU inserted with a MagForce Racing saved game, it will automatically load it. If you wish to start a brand new game, remove the VMU and power off and power on the Sega Dreamcast. **MAGFORCE RACING** recognizes Part A as Player 1, Part B as Player 2, Part C as Player 3 and Part D as Player 4. You can only pick items in the highest class in which you've successfully attained. Here's a rundown of all the possible selections:

Tripod Select:

Four vehicles are offered, each with different characteristics of **TOP SPEED**, **ACCELERATION**, **GRIP AND HANDLING**. Each of the Tripod's characteristics are shown below the tripod.

PULSE RIVAL—This craft offers the highest top speed at the sacrifice of some grip and acceleration. A fast but unforgiving tripod designed for advanced pilots.

SINUS ALPHA—Great grip and handling, with the highest acceleration and a poor top speed. An excellent choice for those who prefer safety over speed.

H+K 303—Exceptional handling with good balance of speed, acceleration and grip. This tripod is an excellent all-around performer.

CYCLONE PRIME—Hailed as the most revolutionary form of transport in 2089, the Japanese designed tripod has the best of all characteristics with a focus on handling and top speed. Using the newly designed Osaka track as a testing ground, designers and engineers were able to push the limit with their creation.

Track Select:



Moscow (Classes 1–4) This 40-million-people metropolis was host of the world's first MK racing track. Built as a symbol of the industrial renaissance in the late 21st century, it is the easiest track of the MK-League. Nevertheless, the breathtaking scenery of downtown Moscow regularly attracts more than a billion people to follow the race on TV.

MARS (Classes 1–4) Designed by the trio of Mars mining companies, and marks the first circuit not on Earth. Located in the soft hills around the Phoenix copper ore mine, the course provides a scenic view of Mars' northern hemisphere—but the terrain will prevent you from sightseeing. You won't need to use the magnet, but if you do, you may get some added benefits.

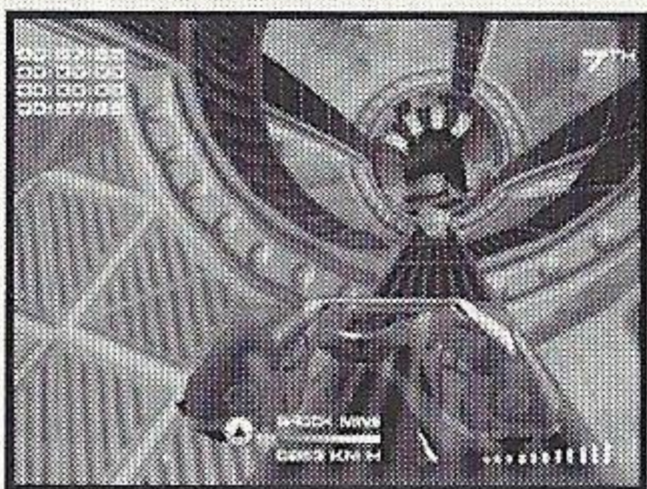
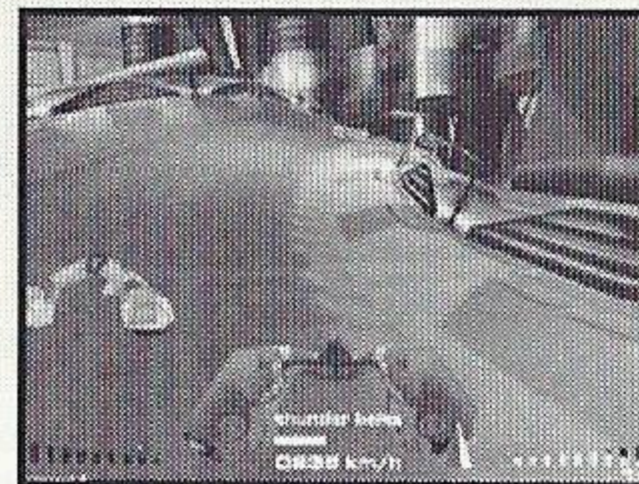

HAWAII (Classes 1–4) The lush panorama provided by the Big Island is only half the fun, with the track offering its own excitement. How about a 360° underwater glass tunnel for a change of pace? You'll need to master your use of the magnet to finish this course.

HIMALAYA (main track, Classes 1–2) The last location sanctioned for league racing is also the most remote on Earth. The track is set amidst the most extreme conditions, jagged peaks and treacherous weather that these mountains have to offer. The magnet is a must here.

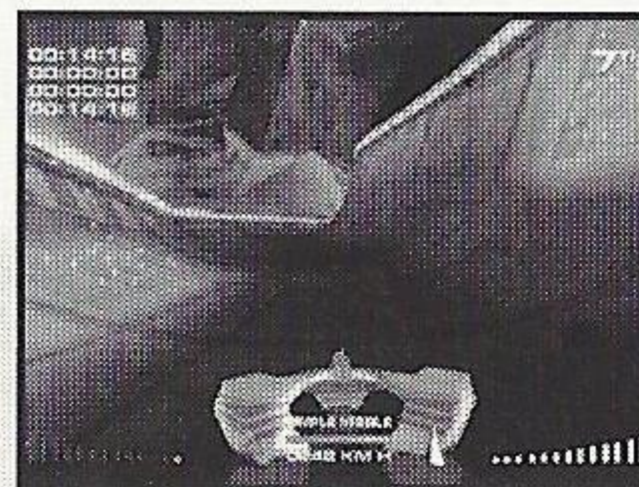

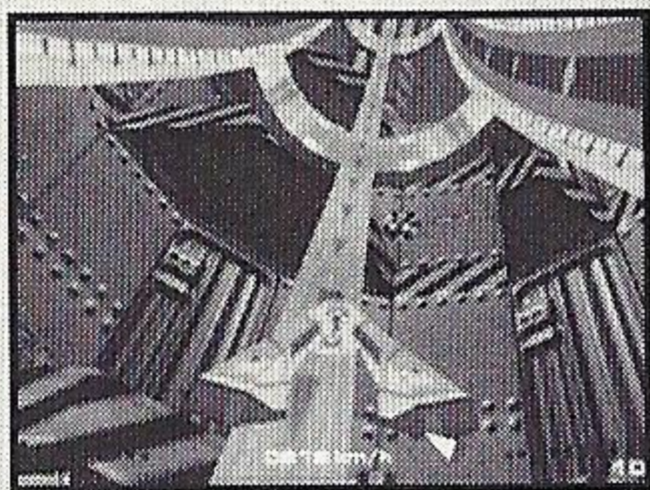

OSAKA (Classes 1-4) Digging out of the ashes of the Third World War, the Japanese government succumbed to the constant pressure of the country's people and designed a truly unique track. Winding high above the industrial downtown buildings, the track features the first full loop nicknamed the "killer loop". Timely use of the magnet on this track will set apart the contender and the pretender.

NEEDLE ROCK (Classes 2-4) When the first images of the one-mile-high landmark Needle Rock were transmitted from Saturn's moon Iapetus by American astronauts, the MK consortium went for the final frontier. In a gigantic effort they constructed this vertical track, where the tripods race to the top through a tunnel inside the rock and speed down along its outside walls. The odd path you'll need to take and gravity just above that of Earth will have you using the magnet frequently.

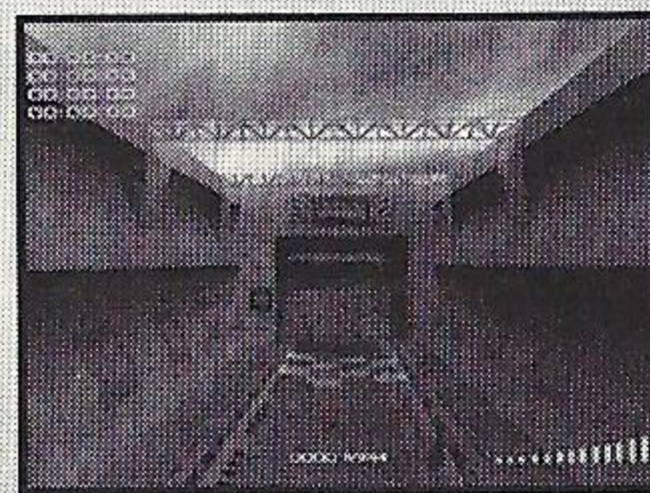
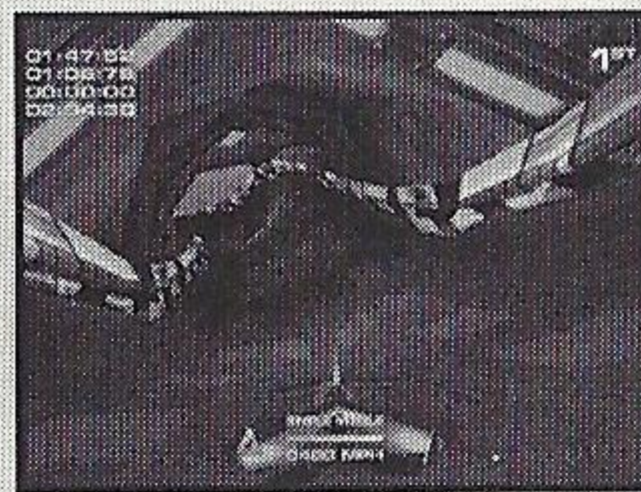

UNDERWORLD (Classes 2-4) After warp drive was achieved in 2063, interstellar space travel became realistic and the MK league jumped at the chance to expand its horizons. Built almost entirely underground due to the harsh environment on Alpha Centauri I, the first track built outside of our own solar system has many twists and turns, including an above ground 360-degree tube. Subspace communications force a 15-minute delay between the race and receiving stations on Earth.

RTAIN

What g

- Nex
- Gar
- EGI
- Exp
- PS
- OPI
- ODI

Do you

- Yes
- No

Place
First Class
Stamp Here

CRAVE ENTERTAINMENT, INC.
Attn: Customer Service Dept.
19645 Rancho Way
Rancho Dominguez, CA 90220

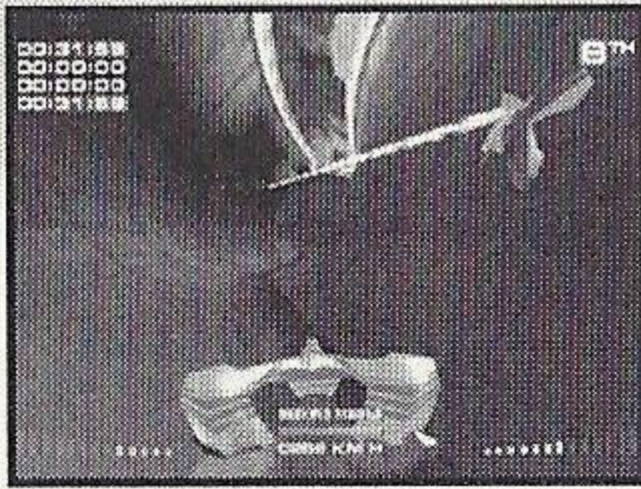

HIMALAYA (*alternative track, Classes 3–4*) This alternative course to the mountain range's main track raises the difficulty by an order of magnitude, even for the most seasoned of MK pilots. Only the elite of tripod pilots is able to master the alternative route, which passes constantly clouded peaks. Of course, you'll also need the magnet to finish the race.

SPACESTATION (*Classes 3–4*) The "Orbital Wharf" started as a factory for building large space-bound vessels, but league officials added MK to its commerce. The station's artificial gravity fields make this track the MK-League's toughest challenge.

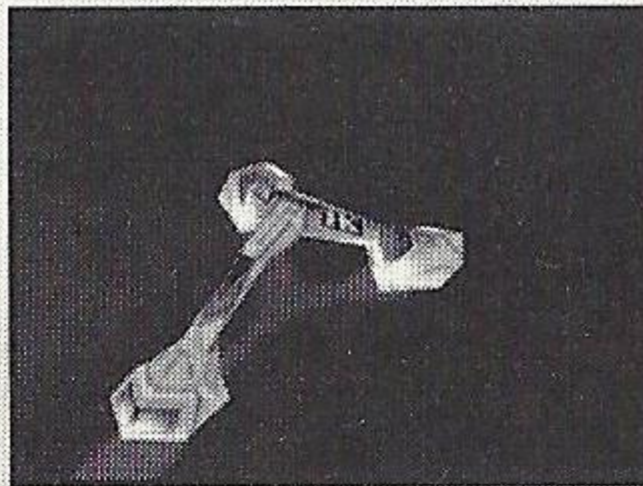
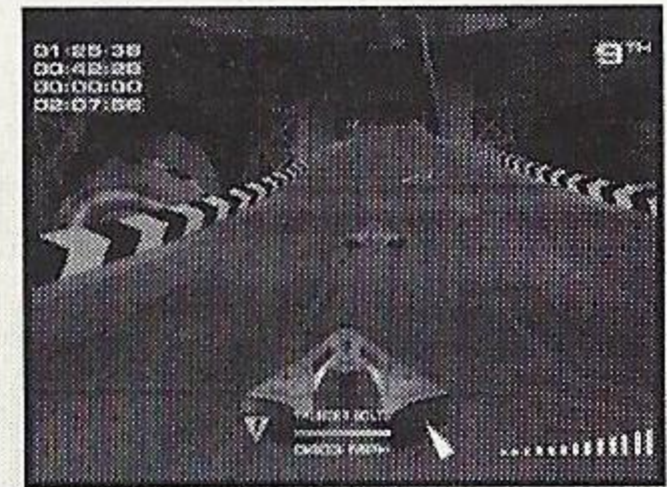

HOLODROM (*Class 4*) The Hartmann & Koch pilot training facilities are located in Hamburg / Central Europe. Inside this holographic flight simulator, pilots are prepared for future racing tracks and special maneuvers. The possibilities in this completely synthetic environment are unlimited.

Race Mode

CHAMPIONSHIP—This race pits you against a field of other Tripod pilots in a three-lap contest that counts toward the league standings and your quest to complete that class of races.

TIME TRIAL—In this challenge you are the only competitor in a race against the clock. You will race 3 laps and attempt to set new lap and overall track records.

SPLIT CLASSIC—2 to 4 Player racing (description on Page 17)

SPLIT ARCADE—2 to 4 Player racing (description on Page 17)

25% FASTER—If you are able to come in first place on every track in all of the leagues, you will be rewarded with this super-fast racing mode.

Options

Use the Up and Down Direction Button to move through the choices, use the A Button to make a selection and use the B Button to back up to the previous menu.

MAGNET HELP—“Enabled” activates automatic magnet assistance, so that the computer engages magnet when it’s necessary; “Disabled” requires manual use of magnet.

VIBRATION—If you have a Jump Pack installed, you can either enable or disable the vibration.

VOLUME CONTROL—Offers manual slide controls for background music (“BGM”) and in-game sound effects (“SFX”).

MONO/STEREO - Allows the choice between Mono and Stereo sound.

HIGHSCORES—This section provides a race-by-race rundown of the players’ highscores for each track in each class. Use the Direction Button up and down to select between Championship Total (all 3 laps), Championship Best Lap, Time Trial Total (all 3 laps) and Time Trial Best Lap. Press the A Button to select your choice. Pressing the Directional Buttons left and right moves through the races in a selected class, while pressing the Directional Buttons up and down moves through the classes.

DEFAULT VIEW—This selects which type of view will be the default perspective when you start a game:

“**OUTSIDE VIEW 1**” is a behind-the-Tripod view from directly behind the craft.

“**OUTSIDE VIEW 2**” is a behind-the-Tripod view with the perspective being farther behind and slightly above Outside View 1.

“**DRIVER’S VIEW**” provides a first-person look through the Tripod windshield, as the driver sees the race.

CONTROLS—Customization of the controller layout is accomplished here: Move to a particular action with the directional buttons, press the A button to select it, move the indicator to the desired button on the controller diagram, then press the A Button to lock it in. You can also choose from 2 pre-selected settings if you wish.

CREDITS—Offers a complete display of all the people responsible for bringing **MAGFORCE RACING** to you.

VMU—Use and maintenance of the VMU takes place here:

“**LOAD**” starts the game using the contents of the selected memory slot.

“**SAVE**” stores the current game settings to the selected memory slot.

POWER-UPS

To help you compete, power-up bonuses are scattered along the track. There are three types of power-up:

GREEN—Coming in contact with these power-ups increases your green energy meter, which helps your Tripod go faster. The longer you are on the energy field, the more energy is collected. As you race, the meter slowly drops, so you should always keep replenishing the energy supply.

YELLOW— These fields increase your yellow meter, which indicates magnet power. Whenever the magnet is activated, magnet energy is consumed and the meter will drop. If you attempt to activate the magnet when all magnet energy is used up, the Tripod will switch to an emergency mode and use energy from the engine, which makes you lose speed dramatically.

PURPLE—These single power-ups help you with a beneficial ability. When you contact one of these power-ups, you randomly get an ability that will be displayed in icon form as well as brief text describing what you have picked up. If you do not use the ability and hit another purple power-up, it will build up the ability to the next type. Each ability has three grades with a common fourth grade:

Missiles

SIMPLE MISSILE—Fires out a dumb missile ahead of your Tripod in a straight line when the Use Bonus button is pressed. The missile will bank off of walls when contact is made so you might want to try some trick shots.

SEEKING MISSILE— As soon as one or more competitors are near enough, the Homing Missile will “lock” the nearest Tripod, indicated by a small box. If you hit

the Use Bonus while an opponent is locked, the missile will trace and hit the target automatically. If the missile is fired without having locked a target, it will behave like a simple missile.

TRIPLE MISSILE—Fires out three simple missiles simultaneously. One from the center of the tripod, one from the left and one from the right.

TURBO RAM—Provides a temporary turbo speed boost and enables you to ram other opponents without harm to your Tripod. Also makes you invulnerable to mines, missiles, lasers and enemy bolts.

Mines

SHOCK MINES—Pressing the Use Bonus button will release a mine on the track behind your Tripod as you travel. Note that you have 5 mines that remain on the track for a limited time. Your own mines can't harm your Tripod.

FLASH MINES—Same as a shock mine except that the mines explode with a flash of light, temporarily blinding the unfortunate opponent who hits it.

DUST THROWER—Guaranteed to slow down and block the vision of any tripod trailing you too closely, the dust thrower is a throwback to smokescreens used by war machines in the First World War to confuse and disorient the enemy.

TURBO RAM—Provides a temporary turbo speed boost and enables you to ram other opponents without harm to your Tripod. Also makes you invulnerable to mines, missiles, lasers and enemy bolts.

Bolts

THUNDER BOLTS—Highly charged blasts of plasma energy which are designed to

slow down the MK tripods on contact. Note that you have seven shots that you can use before the plasma is drained.

SEEKING BOLTS—Same as the Thunder Bolts except these will lock on the nearest tripod. If you hit the Use Bonus while an opponent is locked, the bolt will trace and hit the target automatically. If the bolt is fired without having locked a target, it will behave like a Thunder Bolt.

HEAVY BOLTS—Same as the Thunder Bolts except these are even more powerful. Designed by the team of engineers on Alpha Centauri I to combat the Xenofungus.

TURBO RAM—Provides a temporary turbo speed boost and enables you to ram other opponents without harm to your Tripod. Also makes you invulnerable to mines, missiles, lasers and enemy bolts.

Lasers

LASER BEAM—Taken out of the operating room and mounted on a tripod, this “remedy” will burn up any opponent’s tripod, severely slowing them down in the process.

ION BEAM—A modified laser beam that uses refraction and the bending of light to follow opposing tripods around curves of the track.

TRACTOR BEAM—A very weak tractor beam by starship standards, but more than enough power to propel your tripod like a slingshot past the unsuspecting rival. This will lock onto the closest tripod for easy use.

TURBO RAM—Provides a temporary turbo speed boost and enables you to ram other opponents without harm to your Tripod. Also makes you invulnerable to mines, missiles, lasers and enemy bolts.

MULTIPLAYER

MAGFORCE RACING allows multiplayer games of 2, 3 and 4 players. Depending on the number of controllers plugged into the Sega Dreamcast, the options for the different multiplayer games will either be available or non-accessible.

From the Main Menu, select Race Modes with the A Button and scroll to the right to view the different Multiplayer selections. Press the A Button to confirm which game you choose, select your tripods and choose the START option from the main menu.

Classic mode—Traditional split-screen racing at its best.

Arcade mode—After the discovery of artificial computer intelligence, the MK league was able to enhance power-ups and controls directly by interfacing with the on-board tripod computers. This mode allows for these enhancements to be used, everything from free power-ups to free maximum power-ups to unlimited shots to cease-fires.

CREDITS/ACKNOWLEDGMENTS

MAGFORCE RACING

Developed by VCC ENTERTAINMENT TEAM FEB
Published by CRAVE ENTERTAINMENT

Credits

CRAVE ENTERTAINMENT:

Executive Producer MARK BURKE

Producer MATTHEW PAUL

Associate Producer KEVIN HOEKMAN

QA Manager MIKE SCHNEIDER

Lead Tester JEFF MCLEAN

QA Testers DANIEL ECHEVERRIA, JORGE GOMEZ, JEFF NACHBAUR,
BRIAN WILSON, SOLOMON KUPU

Product Marketing Mgr. MARK GERSH

Publicist ALEX SKILLMAN

Marketing Services Mgr. SHERI FURUMI

Creative Services Mgr. RYAN VILLIERS-FURZE

Creative Assistant ETHAN MALYKONT

VCC:

Product Manager ROBERT KUEHL

Project Manager FRANK SCHLIEFER

Project Leader DIERK OHLERICH

Game Idea and Concept Design FREE ELECTRIC BAND

**Main Programming DIERK OHLERICH, PETER CUKIERSKI,
MARCO SCHULTZ, NILS PIPENBRINCK, TIM BOESCKE**

Track Design and Modeling, Additional Graphics THOMAS MAHLKE, FLORIAN KNAPPE

**3D Design and Modeling ANDREAS SAMLAND, JENS BAUMGARDT,
ANDRE ADAM, CHRISTIAN MELSA**

3D Graphics Optimizing ANDRE ADAM

Sega Dreamcast-Engine Programming MARCO SCHULTZ

SPECIAL THANKS FROM VCC

**STUDIO FUNK, CHRISTIAN WEIKERT, LARS ERIK SCHMIDT, MARKUS SELCHOW (MAGGI),
THOMAS MOOS, JOHN GROVES, DANIEL HUMMER**

GREETINGS

**MEKKA SYMPOSIUM, SCALA FAMILIE, BASTIAN ZUEHLKE,
DAS SNEAK TEAN VOM CITY HH NEON, COLIN HUGHES, PHIL ROGERS, RONNY,
MICHAEL KRAUSE, JÜRGEN KRENZ, HWS FAMILY, TRUST AND HOTROD**

SPECIAL THANKS

**NIMA TAGHAVI, HOLLY NEWMAN, PAUL SACKMAN, BARRY SEATON,
MARTIN SPIESS, MARC BURO, SOPHIE CRISTOBAL, CHRISTIAN GLOE, ARKIN**

Customer Support

You may need only simple instructions to correct a problem with your product. Call the Customer Service Line at 970-392-7022 24 hours a day, 7 days a week.

If you are looking for Hints & Tips for any Crave Entertainment product, please call:

US – 900-903-4468

\$0.95 U.S. dollar per minute

Canada – 900-677-4468

\$1.50 Canadian dollar per minute

Must be 18 years or have parent's permission. Touch tone phone required.

Warranty and Service Information

CRAVE ENTERTAINMENT, Inc. warrants to the original purchaser of this CRAVE ENTERTAINMENT, Inc. Software product that the medium on which this computer program is recorded is free from defects in material and workmanship for a period of ninety (90) days from the date of purchase. The CRAVE ENTERTAINMENT, Inc. software program is sold "AS IS" and without any expressed or implied losses or damages of any kind resulting from use of this program.

If the CRAVE ENTERTAINMENT, Inc. software product fails to comply with this limited warranty, CRAVE ENTERTAINMENT, Inc. agrees to either repair or replace, at its option, free of charge, the noncomplying Crave Entertainment, Inc. software product provided it is return by the original purchaser, postage paid, with proof of purchase to CRAVE ENTERTAINMENT, Inc.'s Factory Service Center.

When returning the program for warranty replacement please send the original product disk(s) or cartridge only in protective packaging and include: (1) a photocopy of your dated sales receipt; (2) your name and return address typed or clearly printed; (3) a brief note describing the defect, the problem(s) you are encountered and the system on which you are running the program; (4) if you are returning the program after the 90-day warranty period, but within one year after the date of purchase, please include check or money order for \$15 U.S. currency per disc or \$30 U.S. currency per Cartridge replacements. Note: Certified mail recommended.

In the U.S. send to:

Warranty Replacements
Crave Entertainment, Inc.
19645 Rancho Way
Rancho Dominguez, CA 90220

This warranty shall not be applicable and shall be void if the defect in the Crave Entertainment, Inc. software product has arisen through abuse, unreasonable use, mistreatment, neglect or reasonable wear and tear. IN THIS WARRANTY IS OBLIGATION IN LIEU OF ALL OTHER WARRANTIES AND NO OTHER REPRESENTATIONS OR CLAIMS OF ANY NATURE SHALL BE BINDING ON OR OBLIGATE CRAVE ENTERTAINMENT, INC. ANY IMPLIED WARRANTIES APPLICABLE TO THIS SOFTWARE PRODUCT, INCLUDING WARRANTIES OF MERCHANTABILITY AND FITNESS FOR A PARTICIPATING PURPOSE, ARE LIMITED TO THE NINETY (90) DAY PERIOD DESCRIBED ABOVE. IN NO EVENT WILL CRAVE ENTERTAINMENT, INC. BE LIABLE FOR ANY DIRECT, SPECIAL, INCIDENTAL OR CONSEQUENTIAL DAMAGES RESULTING FROM POSSESSION, USE OR MALFUNCTION OF THE CRAVE ENTERTAINMENT, INC. SOFTWARE PRODUCT.

Some states do not allow limitations as to how long an implied warranty lasts and/or exclusions of liability may not apply to you. This limited warranty gives you specific legal rights and you may also have other rights, which vary, from state to state.

ESRB RATING

This product has been rated by the Entertainment Software Rating Board. For information about the ESRB rating, or to comment about the appropriateness of the rating, please contact the ESRB at 1-800-771-3772.

Sega is registered in the U.S. Patent and Trademark Office. Sega, Sega Dreamcast, the Sega Dreamcast logo and Sega Bass Fishing are either registered trademarks or trademarks of SEGA Enterprises, Ltd. All Rights Reserved. This game is licensed for use with the Sega Dreamcast system only. Copying and/or transmission of this game is strictly prohibited. Unauthorized rental or public performance of this game is a violation of applicable laws. ©SEGA ENTERPRISES, LTD., 1999. Sega of America, P.O. Box 7639, San Francisco, CA 94120. All rights reserved. Programmed in Japan. Made and printed in the USA.

Product covered under one or more of the following: U.S. Patents No's: 5,460,374; 5,627,895; 5,688,173; 4,442,486; 4,454,594; 4,462,076; Re. 35,839; Japanese Patent No. 2870538 (Patents pending in U.S. and other countries); Canadian Patent No. 1,183,276.

© 2000 VCC Entertainment GmbH & Co. KG. All rights reserved. Published and distributed by Crave Entertainment, Inc. under license. Mag Force Racing, Crave Entertainment and the Crave Entertainment logos are trademarks of Crave Entertainment, Inc. © 1999 Crave Entertainment, Inc. All rights reserved. Crave Entertainment is a registered trademark in the U.S. All other copyrights and trademarks are the property of their respective owners.

Sega is registered in the US Patent and Trademark Office. Sega Dreamcast, the Dreamcast Swirl, are trademarks of SEGA. Sega of America, P.O. Box 7639, San Francisco, CA 94120. All Rights Reserved. Programmed in Japan. Made and printed in the USA. WARNING: Operates only with NTSC televisions and Sega Dreamcast systems purchased in North and South America (except Argentina, Paraguay and Uruguay). Will not operate with any other televisions or Sega Dreamcast systems. Product covered under one or more of the following U.S. Patents: 5,460,374; 5,525,770; 5,627,895; 5,688,173; 4,442,486; 4,454,594; 4,462,076; Re. 35,839; Japanese Patent No.2870538, (Patents pending in U.S. and other countries); Canada Patent No. 1,183,276. The ratings icon is a trademark of the Interactive Digital Software Association.

CRAVE
ENTERTAINMENT

SEGA