

# TEST DRIVE<sup>®</sup> RALLY<sup>™</sup>

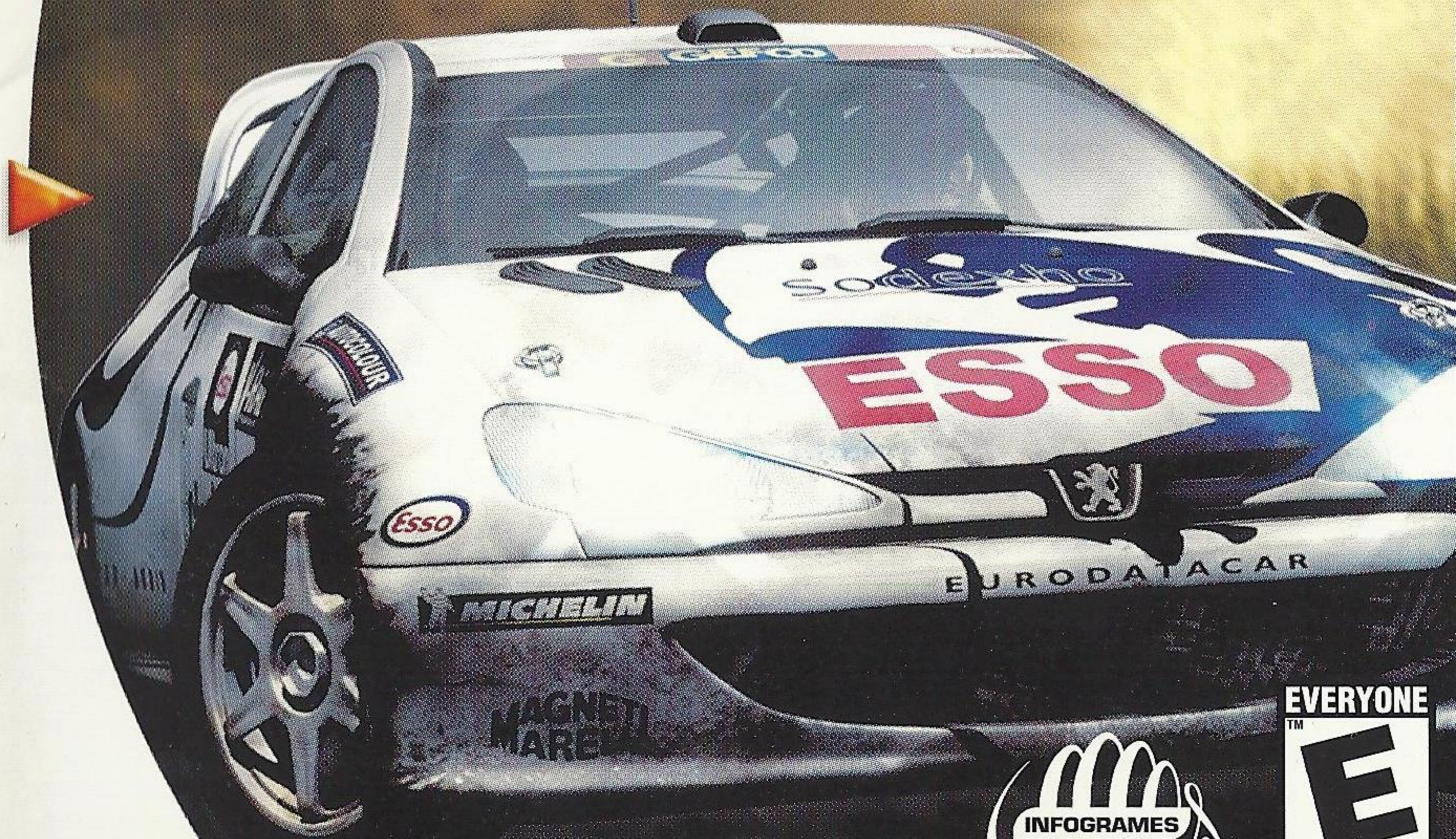

SEGA<sup>®</sup>

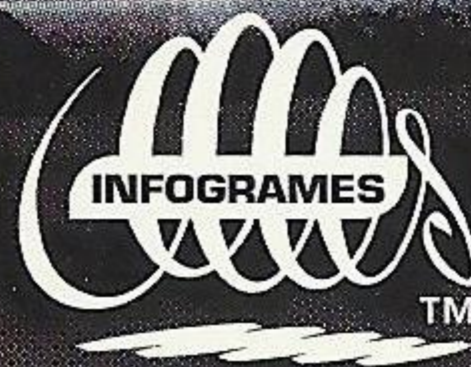

EVERYONE



CONTENT RATED BY  
ESRB

T-15110N

# **WARNINGS Read Before Using Your Sega Dreamcast Video Game System**

## **CAUTION**

Anyone who uses the Sega Dreamcast should read the operating manual for the software and console before operating them. A responsible adult should read these manuals together with any minors who will use the Sega Dreamcast before the minor uses it.

## **HEALTH AND EPILEPSY WARNING**

Some small number of people are susceptible to epileptic seizures or loss of consciousness when exposed to certain flashing lights or light patterns that they encounter in everyday life, such as those in certain television images or video games. These seizures or loss of consciousness may occur even if the person has never had an epileptic seizure.

If you or anyone in your family has ever had symptoms related to epilepsy when exposed to flashing lights, consult your doctor prior to using Sega Dreamcast.

In all cases, parents should monitor the use of video games by their children. If any player experiences dizziness, blurred vision, eye or muscle twitches, loss of consciousness, disorientation, any involuntary movement or convulsion, **IMMEDIATELY DISCONTINUE USE AND CONSULT YOUR DOCTOR BEFORE RESUMING PLAY.**

To reduce the possibility of such symptoms, the operator must follow these safety precautions at all times when using Sega Dreamcast:

- Sit a minimum of 6.5 feet away from the television screen. This should be as far as the length of the controller cable.
- Do not play if you are tired or have not had much sleep.
- Make sure that the room in which you are playing has all the lights on and is well lit.
- Stop playing video games for at least ten to twenty minutes per hour. This will rest your eyes, neck, arms and fingers so that you can continue comfortably playing the game in the future.

## **OPERATING PRECAUTIONS**

To prevent personal injury, property damage or malfunction:

- Before removing disc, be sure it has stopped spinning.
- The Sega Dreamcast GD-ROM disc is intended for use exclusively on the Sega Dreamcast video game system. Do not use this disc in anything other than a Sega Dreamcast console, especially not in a CD player.
- Do not allow fingerprints or dirt on either side of the disc.
- Avoid bending the disc. Do not touch, smudge or scratch its surface.
- Do not modify or enlarge the center hole of the disc or use a disc that is cracked, modified or repaired with adhesive tape.
- Do not write on or apply anything to either side of the disc.
- Store the disc in its original case and do not expose it to high temperature and humidity.
- Do not leave the disc in direct sunlight or near a radiator or other source of heat.
- Use lens cleaner and a soft dry cloth to clean disc, wiping gently from the center to the edge. Never use chemicals such as benzene and paint thinner to clean disc.

## **PROJECTION TELEVISION WARNING**

Still pictures or images may cause permanent picture tube damage or mark the phosphor of the CRT. Avoid repeated or extended use of video games on large-screen projection televisions.

## **SEGA DREAMCAST VIDEO GAME USE**

This GD-ROM can only be used with the Sega Dreamcast video game system. Do not attempt to play this GD-ROM on any other CD player; doing so may damage the headphones and/or speakers. This game is licensed for home play on the Sega Dreamcast video game system only. Unauthorized copying, reproduction, rental, public performance of this game is a violation of applicable laws. The characters and events portrayed in this game are purely fictional. Any similarity to other persons, living or dead, is purely coincidental.

Now you have the opportunity to sit behind the wheel of sixteen of the most famous cars in the World Rally Championship as you zoom through the amazing landscape of twelve different countries! You can even design your own tracks to challenge yourself and your friends. But all of these options come with a price: they can get complicated and you should read this manual carefully before you start to play. However, if you can't wait, every menu function is described at the bottom of the appropriate screen. Certain cars and stages will be displayed in gray; this means you won't be able to access them until you make some progress in the 1-Player game modes. Once you've done that, these grayed-out items will be available in the multiplayer modes. And remember, keep your eyes peeled for shortcuts and surprises as you race along the road to the championship!

START YOUR ENGINES	4
CARS AND DRIVERS	9
GAME MODES	10
THE HUD	16
TRACK EDITOR/GENERATOR	17
SETTINGS	22
GAME OPTIONS	24
SLOW MOTION AND SAVING A GHOST CAR	25
DURING THE RACE	26
CREDITS	27
TECHNICAL SUPPORT	30

STREET  
RACING  
MANUAL



# Start Your Engines

- Make sure your Sega Dreamcast™ is properly set-up and ready to go. For more information, refer to the Instruction Manual that came with your Sega Dreamcast.
- Open the Disc Door by pressing the Open Button and insert your Test Drive V-Rally Sega Dreamcast Specific Disc. Shut the Disc Door.
- Press the Power Button to start your Sega Dreamcast and then follow the on-screen instructions.

Test Drive V-Rally is a 1 to 4-player game. Before turning the Sega Dreamcast power ON, connect the controller(s) or other peripheral equipment into the control ports of the Sega Dreamcast. To return to the title screen at any time, simultaneously press and hold the A, B, X, Y and Start Buttons. This will cause the Sega Dreamcast to soft-reset the software and display the title screen.

Purchase additional controllers (sold separately) to play with 2 or more players.

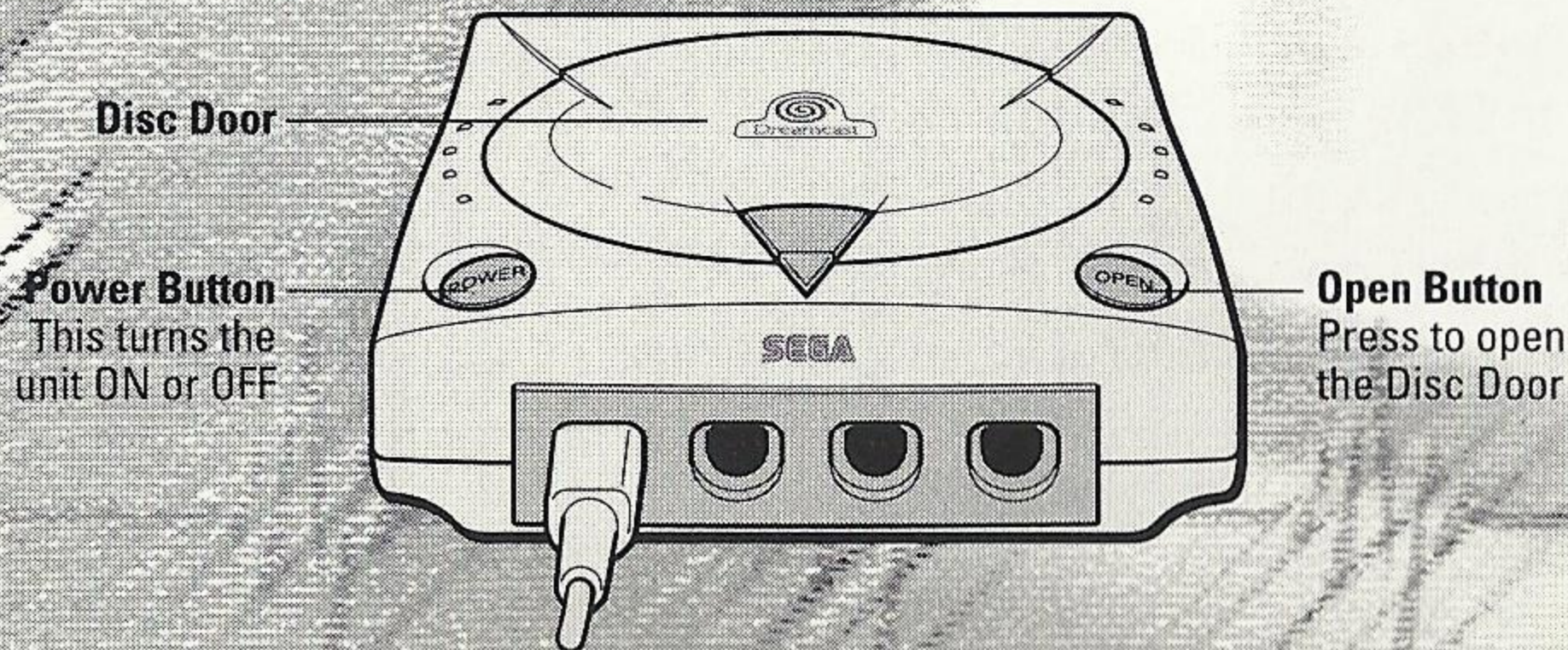

## YOUR CONTROLLER

You can find a controller diagram and the default controls on page 8. Never touch the Analog Thumb Pad or Triggers L/R while turning the Sega Dreamcast power ON. Doing so may disrupt the controller initialization procedure and result in malfunction.

## SAVING GAMES

You will be given the opportunity to save your game at the end of some races, as described later in this manual. You must have a Visual Memory Unit (VMU) inserted into Expansion Socket 1 of the controller plugged into Controller Port A to save your game.

**Important Note:** While saving a game file, **never** turn OFF the Sega Dreamcast power, remove the VMU, or disconnect the controller.

## JUMP PACK

Make sure to insert your Sega Dreamcast Jump Pack into Expansion Socket 2 only. The Jump Pack will not lock into place if inserted into Expansion Socket 1 and may fall out during game play or otherwise inhibit play.

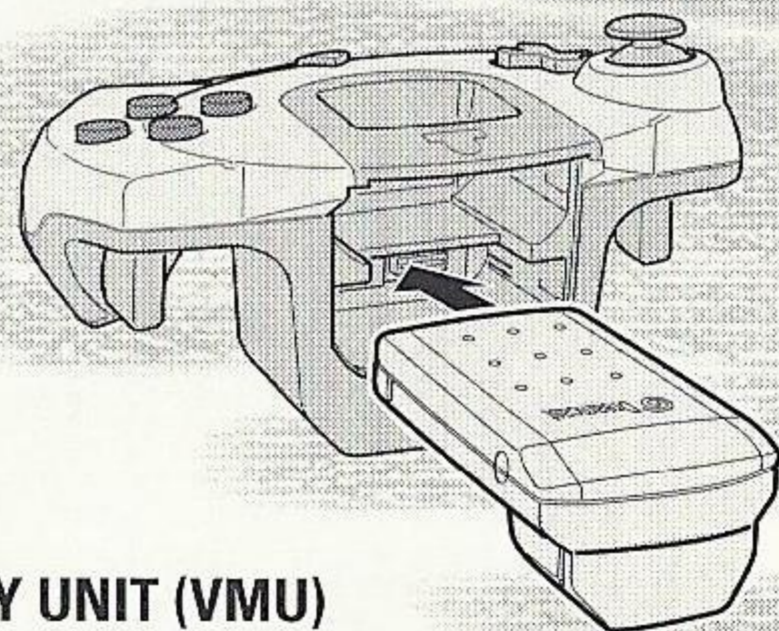

VISUAL MEMORY UNIT (VMU)

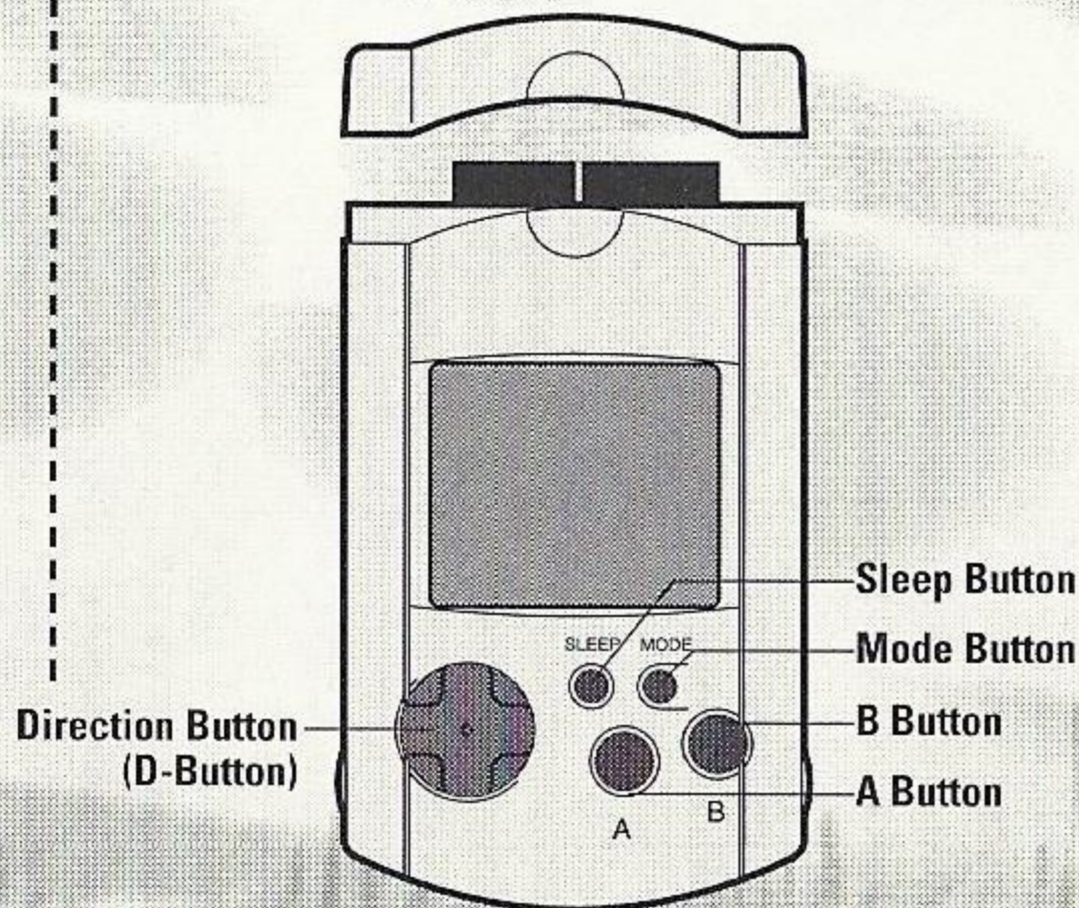

## RACE CONTROLLER

When using the Race Controller, never touch the steering wheel or left and right levers while turning the Sega Dreamcast power ON. Doing so may disrupt the initialization procedure and result in malfunction. If the wheel or levers are accidentally moved while turning the power ON, immediately turn the power OFF and ON again making sure not to touch the Race Controller.

To return to the title screen at any point during game play, simultaneously press and hold the A, B + - and Start Buttons. This will cause the Sega Dreamcast to soft-reset the software and display the title screen.

Front View

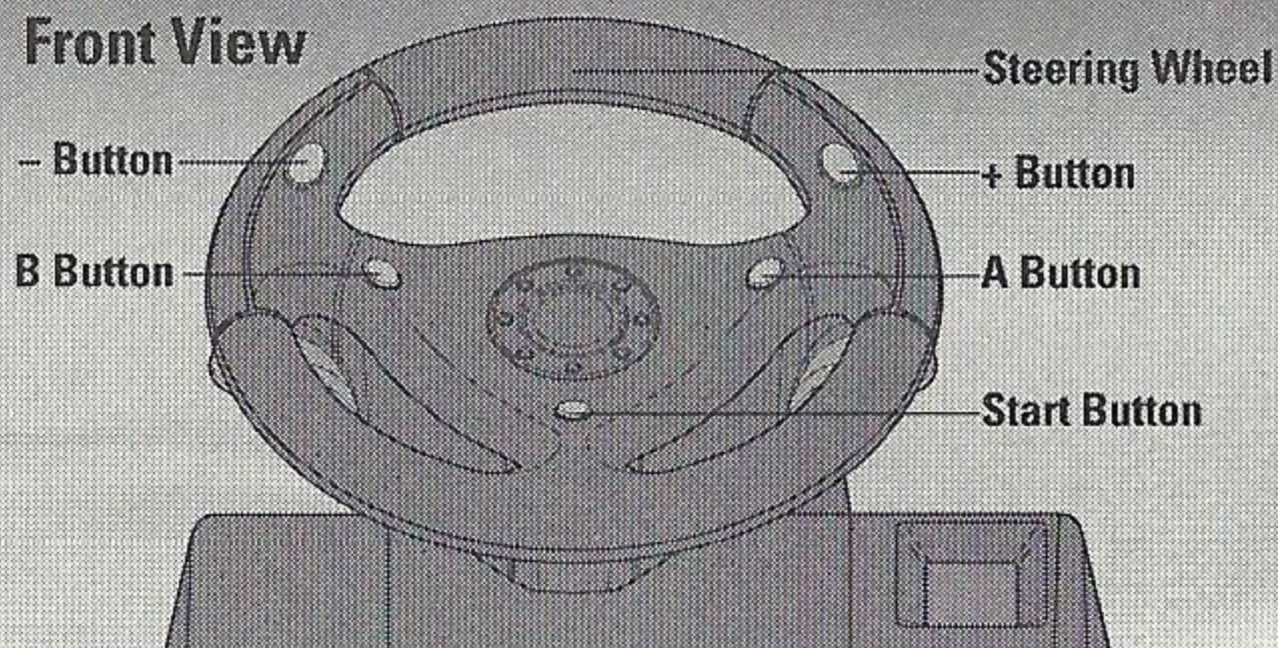

Rear View

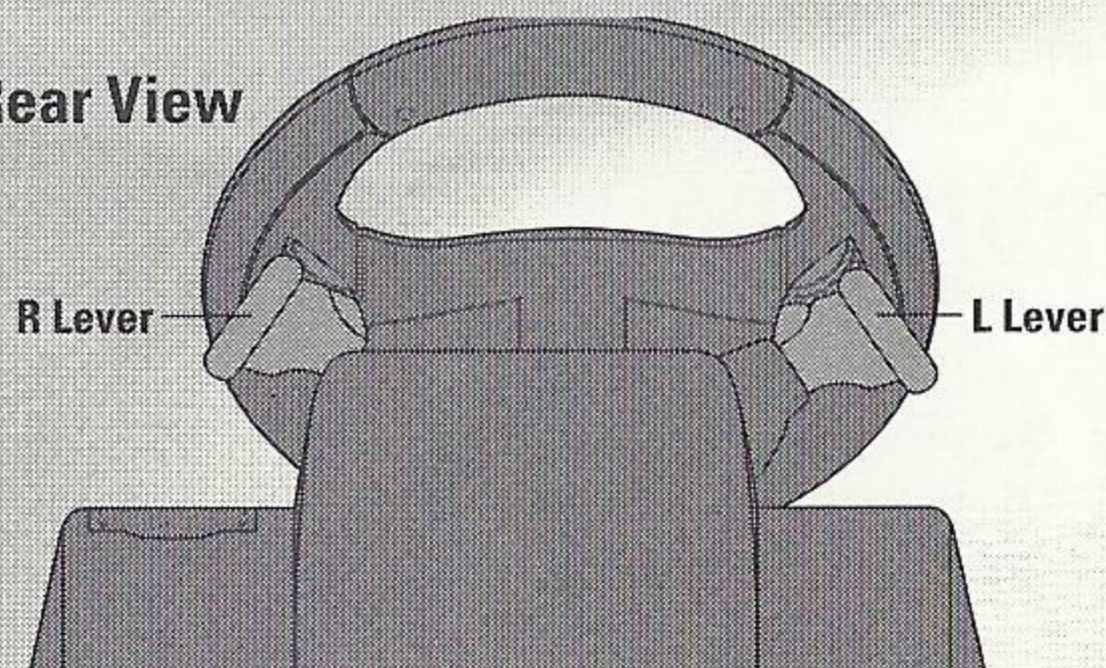

Move around the menus with the Analog Thumb Pad and use the A Button to make selections and enter your choices. The B Button will cancel your selection and/or move you back to the previous menu.

The bottom righthand corner of most menu screens will display your choices and controls for that menu.

## MAIN MENU

Test Drive V-Rally allows up to 4-player simultaneous play on your console. To enable the additional players, you just need to connect the additional controllers. You must have one controller connected for each person that wants to play.

For example, you can't select 4-player mode if you only have 3 controllers connected to your Sega Dreamcast.

The game options enable you to set the different parameters such as display, music etc. Please refer to the "GAME OPTIONS" section for more information.

## CONTROL CONFIGURATION

You can change the default configuration of your controller via the "CONTROLLER" sub-menu of the "DRIVING OPTIONS" menu. Please refer to the "DRIVING OPTIONS" section [page 23] for more information.

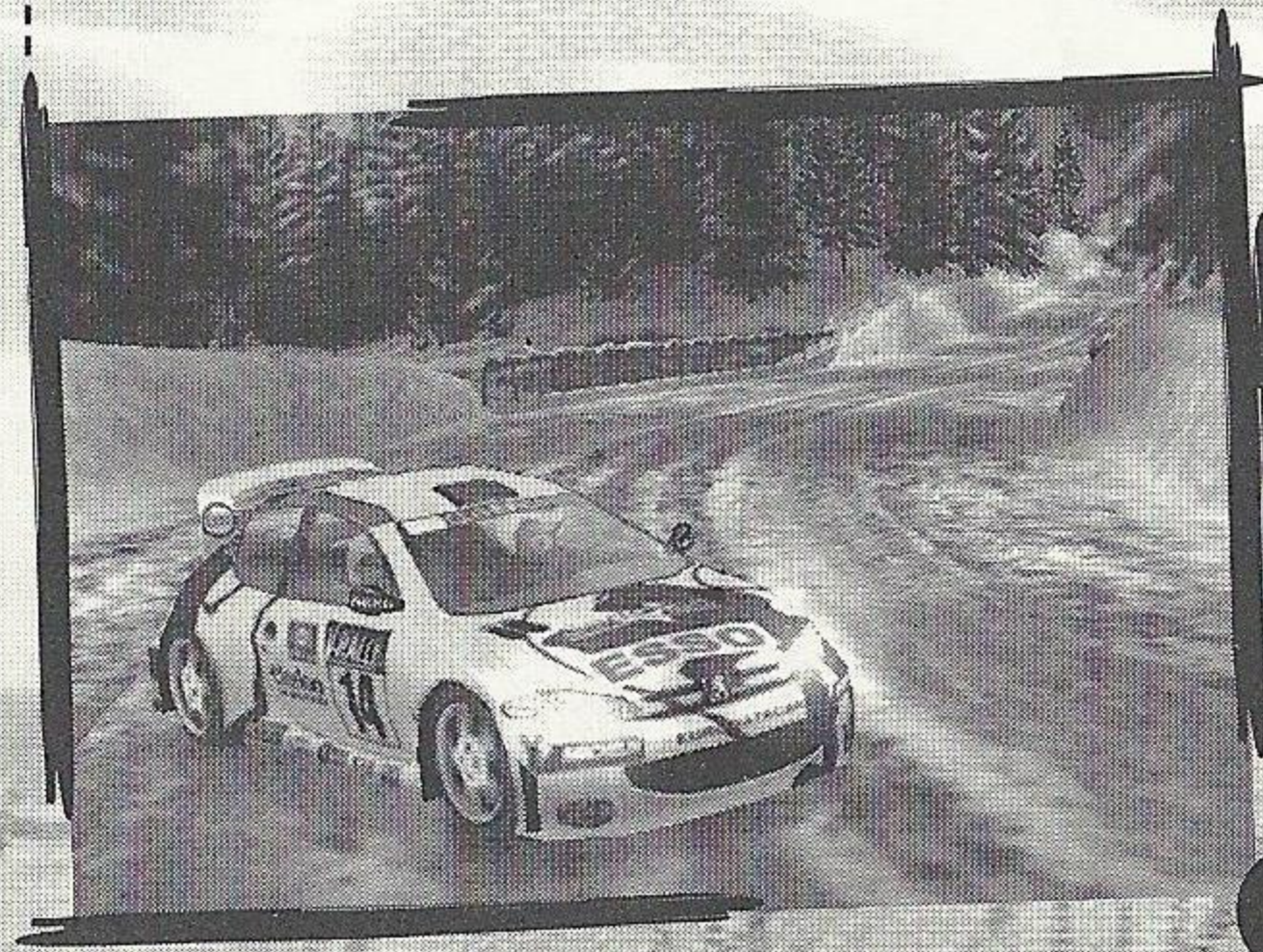

## DEFAULT CONFIGURATION:

Start Button.....	Pause game
Analog Thumb Pad .....	Turn left or right
Button A .....	Gear shift up
Button B .....	Gear shift down
Button X .....	Handbrake
Button Y .....	Change camera view
Direction Button ▲ .....	Rear view mirror
Trigger R.....	Accelerate
Trigger L.....	Brake (hold to switch to reverse gear)

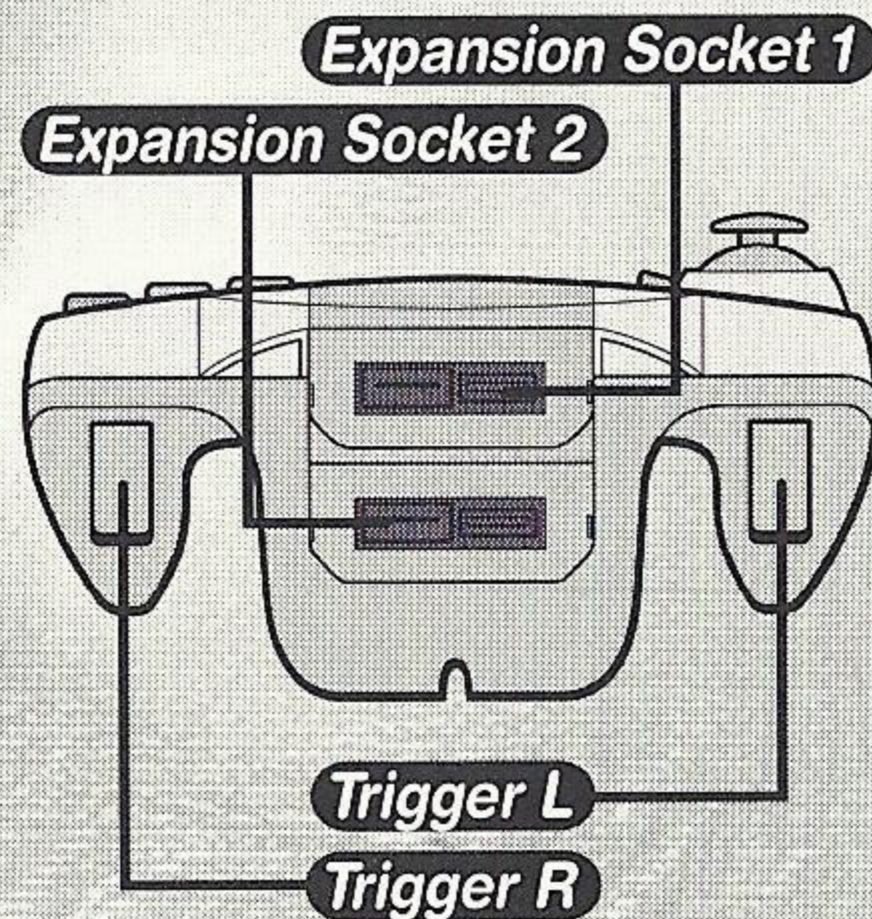
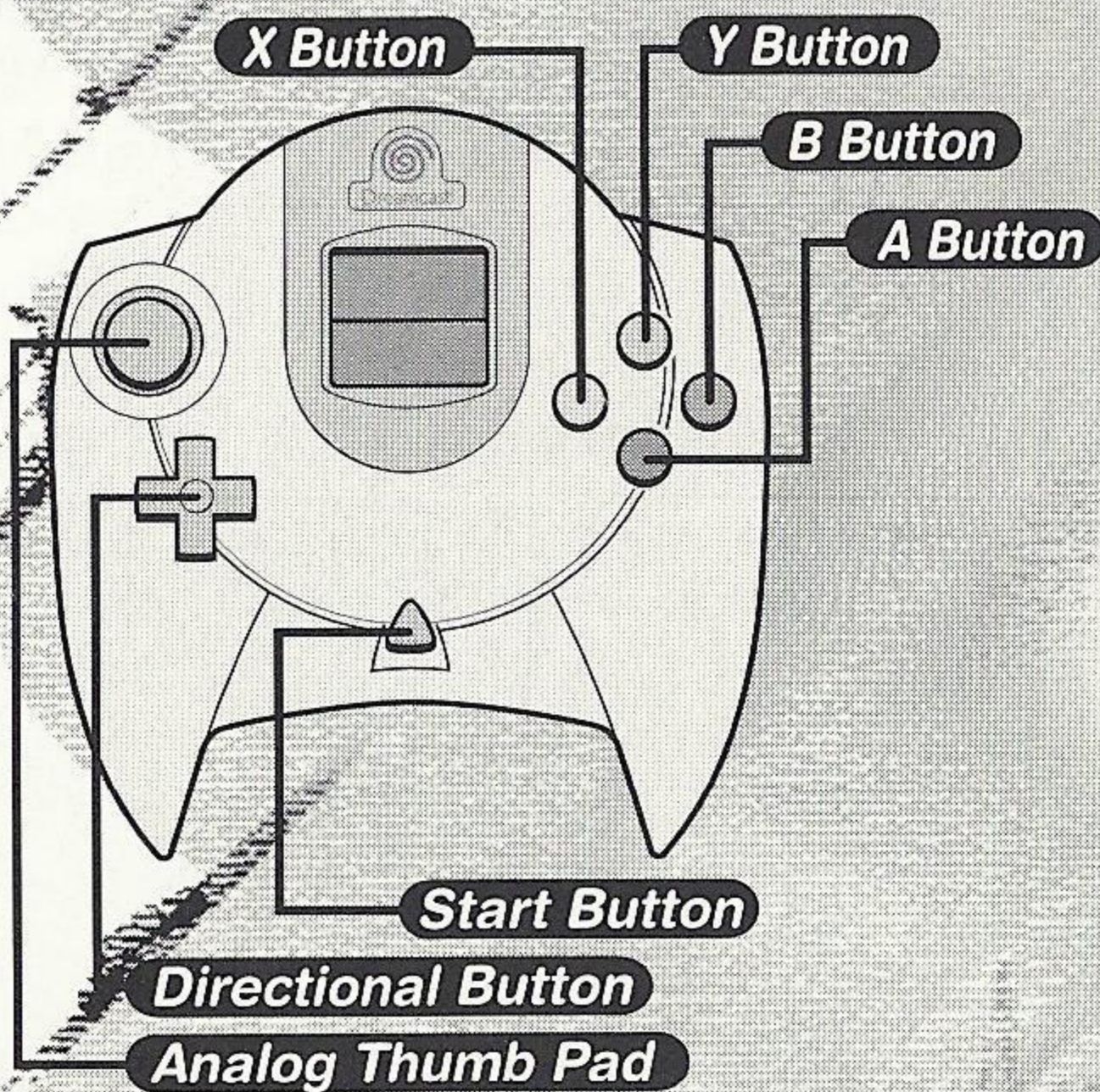



# CARS AND DRIVERS

## DRIVERS

The driver selection screen allows you to either choose a name from a list saved earlier, or to create a new driver. Each name can be up to five letters long. Statistics will be made available to each player (total mileage, total play time, performance points, and driver code).

## CARS

Choose which car you'd like to drive from the car selection screen. There are three classes of cars:

- > 1.6L KIT-CARS (3 cars)
- > 2L KIT-CARS (5 cars)
- > WORLD RALLY CARS (8 cars)

## NOTE :

The WRCs (World Rally Cars) are, technically speaking, the highest performers of the World Rally Championship. All of them are 4-wheel drive with a 2-liter turbocharged engine (300 BHP).

Kit Cars are based on standard car models equipped and modified for the rally. With different engine classes (2 liter, 1.6 liter and 1.3 liter), these cars are often more spectacular than the WRCs. They are easier to handle because they are less powerful and lighter (880 kg).

To help you in your choice, information for each car is available (power, torque, type of engine, gearbox, etc.).

This menu also enables you to take the car for a test drive before starting the race. To come back to the selection screen at any time during your trials, press the Start Button.



# GAME MODES

Test Drive V-Rally comes with 4 game modes, all of which can be played as single player or multiplayer. You can decide to play together either in split-screen mode or in alternate mode (you take on your opponents one after the other). This option is not accessible in all game modes, in which case it appears 'grayed out' on the screen.

## TIME TRIAL

### OBJECTIVE

This mode is made up of all the stages available in other game modes and you should try and achieve the best possible time. There is only one car on the track.

If you are playing in split-screen multiplayer mode, you won't see your opponents driving against you on the track, as the goal of this mode is to get the best track time.

### *3, 2, 1, GO!*

You'll have to choose the country you'd like to race in, and the number of laps for the time trial. If you activate "GHOST CAR" mode and have loaded a previously-saved "Ghost Car", you will see a "ghost image" of that car during your race. Otherwise, you will see a "ghost image" of your best lap time during that race.

Once you've gone through these choices, you'll have to choose the stages you want to race in. You'll also be able to access car and driver settings (please refer to

"SETTINGS" for further information), and best lap times for the stage you're racing in.

You'll also be able to load a "Ghost Car" you already saved on a VMU. The "Ghost Car" option is not accessible if more than two of you are playing.

*NOTE 1 : In the beginning, you have access only to the stages of Arcade Mode Level 1, European Championship Mode and European V-RALLY Trophy Mode. The other stages will be available in Time Trial Mode depending on your progression in the other game modes.*

*NOTE 2 : If you're in multiplayer mode and alternating, you can also select the number of laps each player will have to complete before letting the next player race.*

## ARCADÉ

### OBJECTIVE

Arcade mode will let you gradually discover the special stages. You will have to beat a pre-set time for a stage in order to access the next stage. This mode is divided into three types of special stages, with increasing difficulty levels (LEVEL 1, LEVEL 2, EXPERT), and you'll race against three other cars. You'll have to complete the group of special stages in the allowed time to move on to the next level.

You can choose from three different trials at the start. You lose whenever you do not complete the stages in the allowed time. If you finish first, you will unlock an extra trial.

3, 2, 1, GO!

Once you have chosen the level, the stage you have completed will be displayed on the screen. You will also be able to access car and driver parameters (please refer to "SETTINGS" for further information), and the best lap times for the stage you're racing.

### *Saves:*

You can save at the end of each level. If you leave a level before completing it, all data will be lost.

*NOTE: In the beginning, you have access only to Level 1 of Arcade mode.*



## V-RALLY TROPHY

### **OBJECTIVE**

This mode is made up of 3 different trophies (European, World, Expert) each of which has its own group of special stages. 4 competitors are in the race for each trophy.

The routes are made up of open-loop and circuit stages.

Adding up the time taken for all the races gives you your overall rankings. You will have to finish first in each group to be able to advance to the next group.

There are no checkpoints as in Arcade mode. Regardless of your finishing position, you progress to the next stage. Any damage sustained by your car is visual only and does not affect its performance.

### **3, 2, 1, GO!**

After choosing the Trophy you want to compete for, a screen will display the competing cars and the list of stages that make up the Trophy.

The current stage is displayed on the screen. You will also have access to car and driver settings (please refer to "SETTINGS" for further information), and to best lap times for the current stage.

### **Saves:**

You can save your current Trophy at the end of each stage.

*NOTE: At the beginning, you only have access to the European Trophy.*



## RALLY CHAMPIONSHIPS

### OBJECTIVE

This mode is the most realistic one. You must defeat 7 competitors to win the title of European Champion, World Champion and Expert.

In the multiplayer modes, competitors start the race one after the other on each track, as in a real-life rally.

Each rally includes 2 or 3 open stages. You have to race through all the stages in order to complete the rally.

At the end of each rally, points are awarded to each player depending on their positions:

>1st:	10 points,
>2nd:	6 points,
>3rd:	4 points,
>4th:	3 points,
>5th:	2 points,
>6th:	1 point.

Your access to the different countries during the Championship is sequential.

### *3, 2, 1, GO!*

After choosing your Championship, a screen displays the competing cars and a list of the rallies included in the Championship.

Then a short description of the special stages you'll have to complete in the rally you are about to race in is displayed on the screen.

The pre-race screen invites you to line up for the start of the stage and to access car and driver

settings (please refer to "SETTINGS" for further information), and to best lap times for the stage you're going in.

### ***Repairs:***

A special feature of Championship mode is that the physical damage sustained by your car is displayed in real time. As a result, you will need to repair your car in the pits so you can complete the rally in good time. A damaged car will not give you its best performance on the demanding tracks.

The engine, gearbox, brakes, steering, and suspension may need repairing. They are represented in percentages. You are allowed up to 30 minutes to repair your car.

If your car is badly damaged, you will have to choose the repairs that are absolutely necessary, since you cannot carry out all repairs needed. Be careful! The parts that are not repaired may well give you trouble in the following stages.

### ***Saves:***

You can save your current Championship at the end of each stage and each country.

**Warning:** You can save the game when you finish a special stage. However, if the stage is not the final stage for that country, you will have to begin from that country's first special stage when you restore your game.

*NOTE: At the beginning, you only have access to the European Championship.*

# THE HUD

**Direction Indication:** Shows the direction you should be driving, and also indicates how sharp the upcoming turn(s) will be (Green is the mildest; red is the sharpest).

**Place:** Shows the position of each car, and how far behind the next car you are.

**Stage:** Displays what percentage of the current stage you have completed.

**Lap:** Indicates which lap you are on and total laps in the race.

**Time Left:** How much time you have left to hit the next checkpoint (Arcade mode only)



**Lap Time:** Shows the times for your completed laps, and your pace for the current lap.

**Speed and Gear:** Displays your current speed and which gear you are in.



# TRACK EDITOR/GENERATOR

Create your own tracks with Test Drive V-Rally!

On the Game Mode selection screen, choose Track Editor Mode and then feel free to generate, save, load, change and delete your own tracks.

Use the D-Button to move around the navigation icons. When you want to use a function (each function is described at the bottom of the screen), select it and press the A Button. Then carefully follow the instructions displayed on the screen.

These tracks are made up of blocks. A track must be a minimum of 10 blocks for you to save it or try it out (the number of blocks in your track is shown on the screen).

Please note that track segments cannot cross-over other track segments. You'll be able to create some exciting tracks after just a little practice with the Track Editor. See the next page for a quick look at how to create a track.





There are two ways to go about creating a track. You can build your own track block-by-block [to a maximum of 100 blocks] or you can 'auto-generate' a track. To generate a track automatically, enter the Track Editor and highlight the Generate Form icon. You'll have the choice to make a looped or linear track and can adjust the Length (how long the track is) Bends (How tight the curves are) and Speed (how often curves or straightaways appear.) Once your track has auto-generated, you can use the following tools to help you shape the track to your specifications.



To use a tool to modify the track layout, follow the directions below:

- Highlight the tool you'd like to use and press the A Button.
- Once the tool is selected, move the blue cursor around the track by using the D-Button. If necessary, select the block by pressing the A button.
- Press the D-Button to shape the track the way you would like it to be.
- Press the A Button to keep your changes; press the B Button to return to the previous screen without making any changes.

The remaining tools are described on the next three pages.

**THE GENERATOR (BLUE ICONS)** enables you to quickly generate and save new routes by defining a few important parameters such as country, weather, difficulty level...



**Opening/Closing Track Loops** To close an existing track, the two ends must be close enough and form a realistic angle.



**Generate Elevations** To generate heights, bumps, jumps, movements (up, down) on an existing track.



**Generate Form** To create open tracks or loops by defining certain parameters (bends, length and speed).

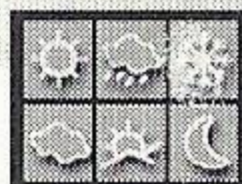

**Change Weather** Press the A Button to change weather conditions [Warning: choice of weather conditions depends on the country chosen].



**Change Country** Press the A Button to change country. This will change the type of terrain for the track.

**THE EDITOR (ORANGE ICONS)** gives you the possibility of designing your whole route just by drawing.



**Redo** Allows you to repeat previous operation(s).



**Cancel** Allows you to cancel previous operation(s).



Building Mode

Press the A Button to access building mode, which allows you to build your track by following instructions given on screen.

---



Height Mode

Press the A Button to access height mode, which allows you to adjust heights by following instructions given on screen.

---



Bend Mode

Press the A Button to access bend mode, which allows you to fine-tune your bends by following instructions given on screen.

---

*NOTE: The bend mode icon changes depending on the kind of track (open-looped or closed-loop).*

## SCREEN DISPLAY FUNCTIONS (GREY ICONS):



Zoom Mode

Allows you to zoom in or out of the track.

---



Shift Mode

Allows you to move the track on screen to get a better view.

---



Rotation Mode

Allows you to rotate the track horizontally or vertically to view heights better.

---



Screen Center

Allows you to relocate the track at screen center.

---

## USAGE FEATURES (GREEN ICONS):



Save Track

Allows you to save your track.



Delete track

Allows you to delete an existing track to build another one.



Try Track

Allows you to test the track displayed on screen.



Exit

Quit the editor.

## How to get best times on your tracks created and saved in the generator/editor.

All tracks created and saved in the track generator/editor are accessible in Time Trial Mode. They show up in the country you created them in with the same characteristics (name, weather, route, heights, etc.); you just have to select them as a normal track. These tracks are placed just after the special stages you already opened up in the game.

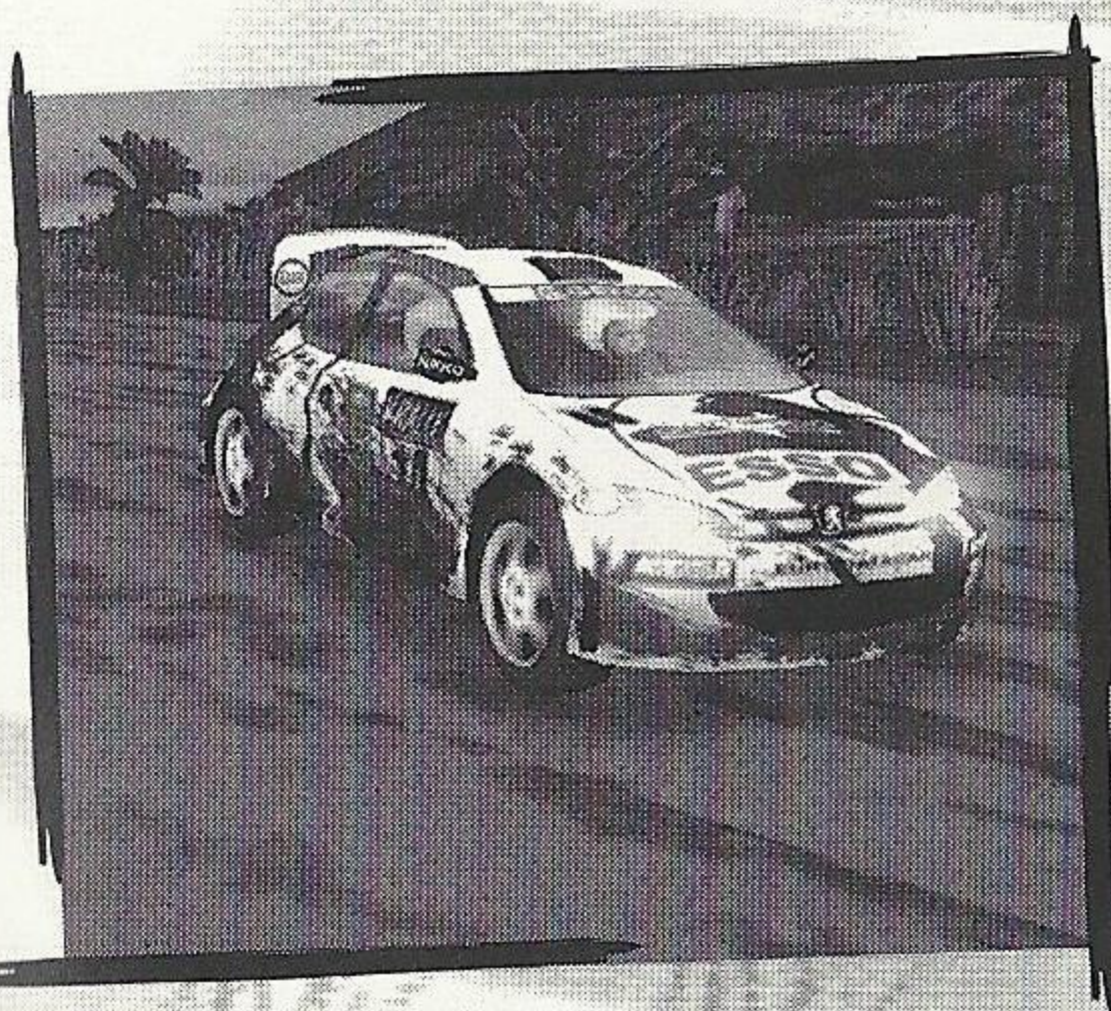



# SETTINGS

The game gives you access to two types of settings:

## CAR SETTINGS

Depending on the type of terrain and weather conditions encountered (earth, tarmac, gravel, wet roads, etc.) you can adjust your car's basic parts.

### *Tire selection:*

You're given a choice of tires, each having specific characteristics. It's up to you to make the right choice depending on the situation.

### *Gearbox:*

Here you can decide on the gear ratios you wish to use (short for maximum acceleration, average, or long for maximum speed).

You're offered a range of 7 configurations.

### *Chassis :*

This sub-menu gives you access to several important settings:

› *Suspension:* If you are driving on pavement, it is better to use hard suspension. On rough terrain, soft suspension will give the car more stability.

› *Car Height:* You can adjust car height to fit the type of terrain encountered.

› *Over/Understeer:* You can choose to have your car understeer or oversteer. A track with gentle bends will require an understeering car while you'd be better off with an oversteering car on a track with many sharp turns.

**Brakes:**

This sub-menu gives you access to the following settings:

- › **Strength:** you can make your braking harder or softer
- › **Balance:** You can distribute the braking strength evenly or set for more force to either the front or rear brakes.

**DRIVING OPTIONS****Co-pilot:**

You can choose the gender of your co-pilot.

**Gearbox:**

You can choose your type of gearbox, automatic or manual.

**Assistance:**

If you want, you may use braking assistance to help you around turns.

**Steering:**

You can adjust the sensitivity of your controller here by picking from a scale of 7 values to adapt the controller to your driving style.

**Controllers:**

This sub-menu allows you to reconfigure your controller buttons or switch back to the factory-standard settings and turn the vibration on or off (if you are using a Jump Pack).

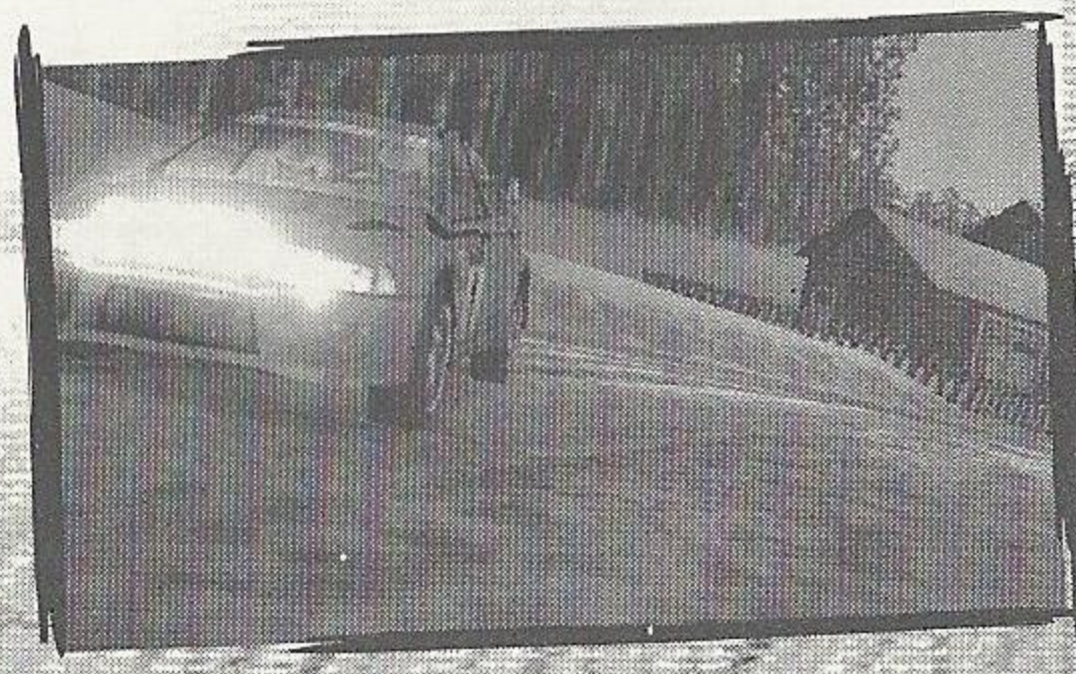



# GAME OPTIONS

Accessible from the main menu, these options let you set the Test Drive V-Rally game parameters.

The following options are available:

**DISPLAY:** Set image format [4/3, 16/9] on your TV screen, set display preferences [speedometer in mph or kph], center picture to suit TV screen, split screen for two-player mode [vertical or horizontal].

**AUDIO:** Select volume levels [menus, music, atmosphere and voice], choose language for co-pilot instructions, choose music to accompany game [random, end-to-end, loop], choose the music track.

**MEMORY CARD:** In this menu you can load, save and delete games and scores.

**GAME SCORES :** This lets you see all your scores in the various game modes and also delete your scores.

**PROGRESSION :** This menu shows what you have acquired through winning in the Arcade, Trophy and Championship modes. As you accumulate victories, grayed out areas disappear to let you see new tracks and stages and hidden cars. The tracks, stages, and cars will then be available in the game.







# SLOW MOTION AND SAVING A GHOST CAR

## **SLOW MOTION:**

At the end of each stage in each mode, you can review your race in slow motion.

Follow the instructions on the bottom of the screen. When viewing the slow motion replay, you'll have access to the following navigation icons:

-  Press the A Button to reset the slow motion.
-   Sets slow motion to freeze or play. Press the A Button to freeze the slow motion, then the A Button again to resume play.
-  Lets you accelerate slow motion by keeping the A Button pressed down.

## **SAVING A GHOST CAR:**

When you view your slow motion in Trial Mode, you'll be able to save your slow motion (which is always your best time on the track) by following the on-screen instructions. This can be a pacer for your future trials on the same track.

## **LOADING A GHOST CAR:**

To load a saved Ghost Car, select the stage the Ghost Car was saved in. The load Ghost Car option will then change from grey to normal and then need to select this option to directly access the track and try and beat this Ghost Car.

# DURING THE RACE

You can press the Start Button to pause the race during any game mode. This also gives you access to a certain number of options, depending on the mode you are playing.

Depending on the situation, you can:

- > Resume the race.
- > Access sound options to adjust music, atmosphere and co-pilot volume levels.
- > Access display options to configure the display of information appearing on the screen (Rev. counter, track map, best lap, lap time, etc.) as you wish. You will also be able to choose a customized view.
- > Quit the current mode and return to the main menu.

*NOTE: Apart from the options detailed above, when you pause the game in Trial Mode you can also:*

- > Restart the lap.
- > Change car.
- > Access car settings.
- > Access driver settings.
- > Quit the current stage and return to the stage selection screen.

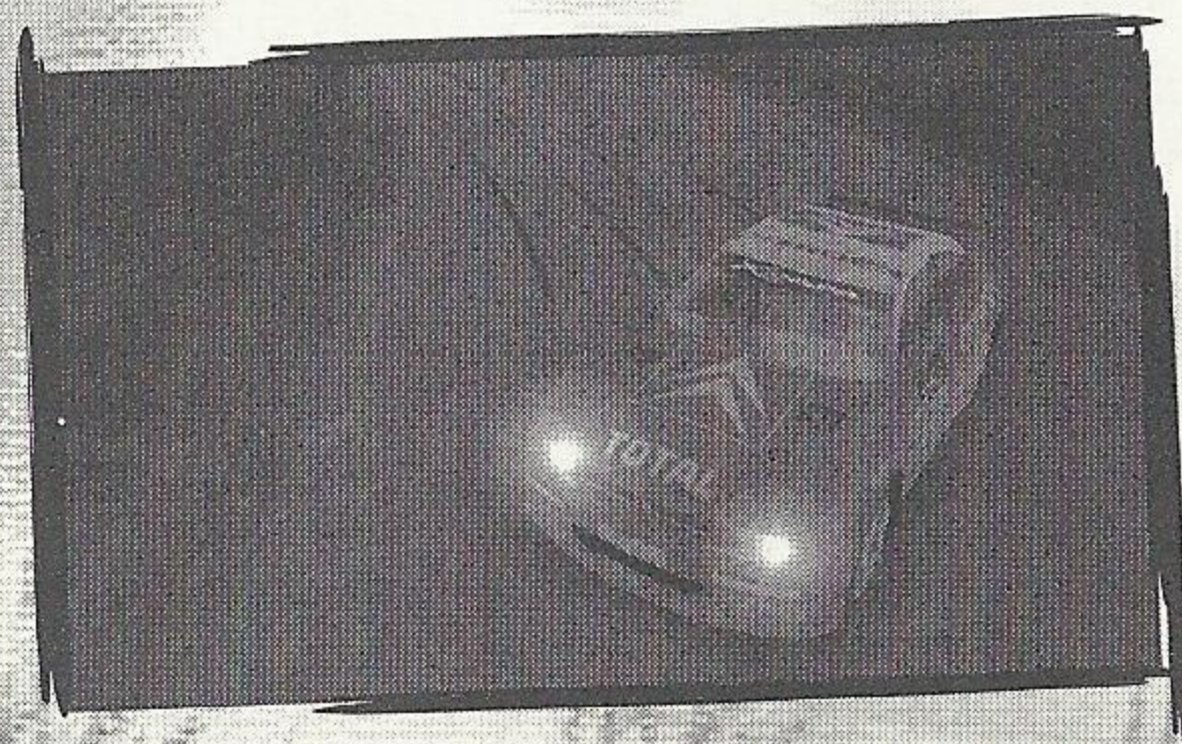

# CREDITS

## INFOGAMES:

**VP Sports Label:**

Mickaël SPORTOUCH

**Motorsports Director:**

Arthur HOUTMAN

**Producer:** Olivier RAF-

FARD

**V-Rally Brand Manager:**

Franck GIROUDON

**Junior Producer:**

Noël KECHICHIAN

**Junior Product**

**Manager:**

Fredéric ARCHE

**Operation Manager:**

Nadine LESOURD

**Licensing:** Fabrice GATTI

**Legal Affairs:**

Mathias SCHNEIDER

**PR Coordination:**

Catherine LOUVIER

Marie-Emilie REQUIEN

**Design studio:**

Emmanuelle TAHMAZIAN

Patrick CHOUZENDOUX

Michel MEGOZ

Sylvie COMBET

Sophie WIBAUX

**Technical Department:**

Emmanuelle

PERIGAULT-VIGIER

Rebecka PERNERED

**QA Manager:**

Olivier ROBIN

**Qualitative Test**

**Supervisor:**

Dominique MOREL

**Qualitative Test**

**Co-ordinator:**

Emmanuel DESMARIS

**Qualitative Test**

**Testers:**

Leïla SOUI

Arnaud ROCCON

Jean-Yves LAPASSET

Nicolas PACAUT

Elise BERTHELOT

**Debugging Test**

**Co-ordinator:**

Jérôme DI TULLIO

**Debugging Test Team**

**Leader:**

Matthieu FLECHAIRE:

**Debugging Test Testers:**

Emmanuel ALTUR

Adrien BALMELLE

Valérie BARRANCO

Madjid BELLABES

Agnès BURDIN

Bertrand CABALLERO

Julien CARTIER

Damien DEVAUX

Philippe DUHEM

Kim EA

Véronique LEGRAND

Arnaud MOLIN

Jérémie RACAMIER

Michael SAIGHI

David SEIGNERET

**Original Production**

**Team:**

Stéphane BONAZZA

Estelle MAGNIN



**Thanks to:**

Jean-Philippe AGATI  
Eric MOTTET  
Olivier GOULAY  
Pierre VU  
Yves LE BIHAN  
Hélène PERSOD  
Laurence DUFOUR  
Antoine MOLANT  
Stéphane PRADIER  
Alex SAP  
François RIBEIRO  
Fabrizia PONS  
Hervé PANIZZI  
Manfred HIEMER  
Fred GALLAGHER  
Jean-Marc VINATIER  
Alistair BODIN

**Consultant:**

Ari VATANEN

**Original interface  
designed by**

Telescope  
Cyril VIEU  
Patrick LOISEL

**Music fuelled by SIN**

(p) & © 1998-1999 Recall  
Publishing.

Courtesy of Virgin  
France

**Publishers:**

Recall Publishing /  
Universal Music  
Publishing France  
Lp: "Noisy Pipes Lovely  
Noises"

**Additional music by**

Piggy Pie/ Rhapsody  
s.a.r.l.  
Fred MENTZEN

**Cinematics by DigiMania**

a member of Digital  
Animations Group plc

**Executive Producer:**

Laurie MCCULLOCH

**Lead Artist**

Andrew BRADBURY

**3D Artist:**

Nikos GATOS  
Lorna MCCULLOCH  
Simon AUCHTERLONIE  
Sam ASSADIAN  
Ian BROWN  
Sergio CAIRES

**For Infogrames**

**Entertainment (US):**

**Director of Product**

**Development:**

Chris DOWNEND

**Associate Producer:**

Dave COSTELLO

**VP of Marketing:**

Mike MARKEY

**Director of Product**

**Marketing:**

Laddie ERVIN

**Product Marketing Manager:**

Scott MCCARTHY

**Lead Tester:**

Jeffrey L. LONEY

**Assistant Lead Tester:**

Richard "SUD" BROCK

**Testers:**

Greg AKATIFF  
Jason CORDERO  
Jason COTE  
Chris PLEPP  
Clayton WOLFE  
David P. STRANG  
Kihn WILLIAMS  
Tim MOORE

**Documentation:**

Bruce HARLICK

**Creative Services:**

Sheryl KNOWLES  
Mark GLOVER

**Director Online Marketing:**

Jonathan TAGLE

**Online Marketing Manager:**

Kiana TRAN

**Web Producer:**

Jason STOKKE

**PR Team:**

Tom RICHARDSON

Mika KELLY

**EDEN STUDIOS****Studio Director:**

Stéphane BAUDET

**Project Manager:**

David NADAL

**Lead Programmers:**

Mickaël POINTIER

Yannick GEFFROY

Jean-Yves GEFFROY

**Programmer:**

Laurent GIAUD

**Track Tuning & Design:**

Yannick BLANCHOT

**Art Director:**

Laurent RUSSO

**Car Production Artists:**

Robert FRIEL

Matthias BAILLET

**Track Production****Supervisor:**

Vincent JOUBERT

**Circuit Tracks Artist:**

Philippe DOUMENG

**Front-End Artist:**

Sébastien MITTON

**Original Track****Production:**

Studio Etranges

Libellules

**Internal Producer:**

Minka MAASDAM

**Internal Production****Team:**

Virginie BALLAND

Emmanuel OUALID

**R&D Manager:**

Marc-Antoine ARGENTON

**Tool Programmer:**

Sylvain RUARD-DUMAINE

**Original Programming**

Sébastien TIXIER

Pierre-Arnaud LAMBERT

**Music & Sound Effects:**

Thomas COLIN

Manuel LAUVERNIER

**Internal QA Manager:**

Frédéric MARCHETTI

**Internal QA Testers:**

Yannick PATET

Nicolas RODET

Olivier DE SAINT JEAN

**SPECIAL THANKS TO:**

AUDI AG

AUTOMOBILES CITROEN &amp;

CITROEN SPORT

AUTOMOBILES PEUGEOT &amp;

PEUGEOT SPORT

FIAT AUTO

FORD MOTOR COMPANY Ltd.

Ford Focus WRC and Ford

Escort WRC used under

license from Ford Motor

Company.

FUJI HEAVY INDUSTRIES

Ltd. &amp; PRODRIVE Ltd.

HYUNDAI MOTOR COMPANY &amp;

MOTOR SPORT DEVELOP-

MENTS

MICHELIN &amp; MICHELIN NORTH

AMERICA

MITSUBISHI &amp; RALLIART

MOTUL

NISSAN MOTOR CO Ltd.

RENAULT &amp; RENAULT SPORT

SEAT, S.A. &amp; SEAT SPORT

SKODA France &amp; SKODA

Motorsport

TOYOTA MOTORSPORT GmbH

VAUXHALL MOTORS LIMITED



# TECHNICAL SUPPORT

Infogrames provides customer service, news, demos and technical support on these on-line services:

**Phone:** Infogrames has some of the friendliest and knowledgeable Technical Support Representatives in the industry. We can help you by phone between the following hours: Monday - Friday 8:00 am - 6:00 pm Pacific time at (425) 951-7106.

**FAX:** Faxes may be sent anytime to: (425) 806-0408. Please include your phone number on all fax transmissions.

**Online:** <http://www.ina-support.com>  
[help@us.infogrames.com](mailto:help@us.infogrames.com)

**Postal Contact:** Humongous Tech Support  
131100 North East 177th Place  
Suite B 101 Box 180  
Woodinville, WA 98072-9965

## Infogrames Hint Line

1-800-454-HINT: \$.99/minute. If you're under 18, please get a parent's permission before calling.

## Other Infogrames Products

To order other fine products from Infogrames, call 1-800-245-7744 or visit our web site, <http://www.us.infogrames.com>.

## 90-Day Warranty

Infogrames Entertainment, S.A. warrants for a period of 90 days from the date of purchase by the original purchaser of this software that the medium on which it is recorded will be free from defects in materials and workmanship. Defective media which has not been subjected to misuse, excessive wear or damage due to carelessness may be returned during the 90-day period without charge. To receive warranty service:

1. DO NOT return your defective disc to the retailer.
2. Notify Infogrames. Customer Service of the problem by calling (425) 951-7106 Monday - Friday between the hours of 8:00 am -6:00 pm (Pacific Time). Please do not send your disc to Infogrames before calling. Infogrames can also be reached 24 hours a day by FAX at (425) 806-0480 or on the World Wide Web at <http://www.ina-support.com>.
3. If a Customer Service Technician is unable to solve this problem by phone, you will be given a Return Authorization number. Record this number on the outside packaging of your disc (be sure your packaging is at least 4" x 6", as many shipping companies will not ship anything smaller.) Send the disc and your sales slip or similar proof-of-purchase within the 90-day warranty period to: Humongous Tech Support, 13110 North East 177th Place, Suite B 101 Box 180, Woodinville, WA 98072-9965 5300.

After the 90-day period, defective media may be replaced in the United States for \$10 (U.S. dollars; plus 8.25% sales tax if the purchaser resides in California). Make checks payable to Infogrames Entertainment S.A. and return to the address listed above. (To speed processing, please do not return manuals or game boxes.)

**IN NO EVENT SHALL INFOGRAMES ENTERTAINMENT S.A. BE LIABLE FOR ANY DIRECT, SPECIAL, INCIDENTAL OR CONSEQUENTIAL DAMAGE WITH RESPECT TO THE SOFTWARE OR USER MANUAL EXCEPT AS PROVIDED ABOVE. INFOGRAMES ENTERTAINMENT S.A. MAKES NO WARRANTIES, EITHER EXPRESS OR IMPLIED, WITH RESPECT TO THE SOFTWARE OR USER MANUAL, AND EXPRESSLY DISCLAIMS ALL IMPLIED WARRANTIES, INCLUDING WITHOUT LIMITATION, THE WARRANTY OF MERCHANTABILITY AND OF FITNESS FOR A PARTICULAR PURPOSE.**

## LEGAL NOTICE

© 2000 Infogrames Entertainment S.A. All rights reserved. All vehicles, company names, trademarks and logos present in the game, are reproduced with the authorization of the owners. Company names, logos & trademarks are protected by Intellectual Property Rights.

## ESRB RATING

This product has been rated by the Entertainment Software Rating Board. For information about the ESRB rating, or to comment about the appropriateness of the rating, please contact the ESRB at 1-800-771-3772.

Sega is registered in the U.S. Patent and Trademark Office. Sega, Dreamcast, and the Dreamcast logo are either registered trademarks or trademarks of SEGA Enterprises, Ltd. All Rights Reserved. This game is licensed for use with the Sega Dreamcast system only. Copying and/or transmission of this game is strictly prohibited. Unauthorized rental or public performance of this game is a violation of applicable laws. © SEGA ENTERPRISES, LTD., 2000. Sega of America, P.O. Box 7639, San Francisco, CA 94120. All rights reserved. Made and printed in the USA.

Product covered under one or more of the following: U.S. Patents No's: 5,460,374; 5,627,895; 5,688,173; 4,442,486; 4,454,594; 4,462,076; Re. 35,839; Japanese Patent No. 2870538 (Patents pending in U.S. and other countries); Canadian Patent No. 1,183,276.

**SEGA**<sup>®</sup>

# AVAILABLE NOW

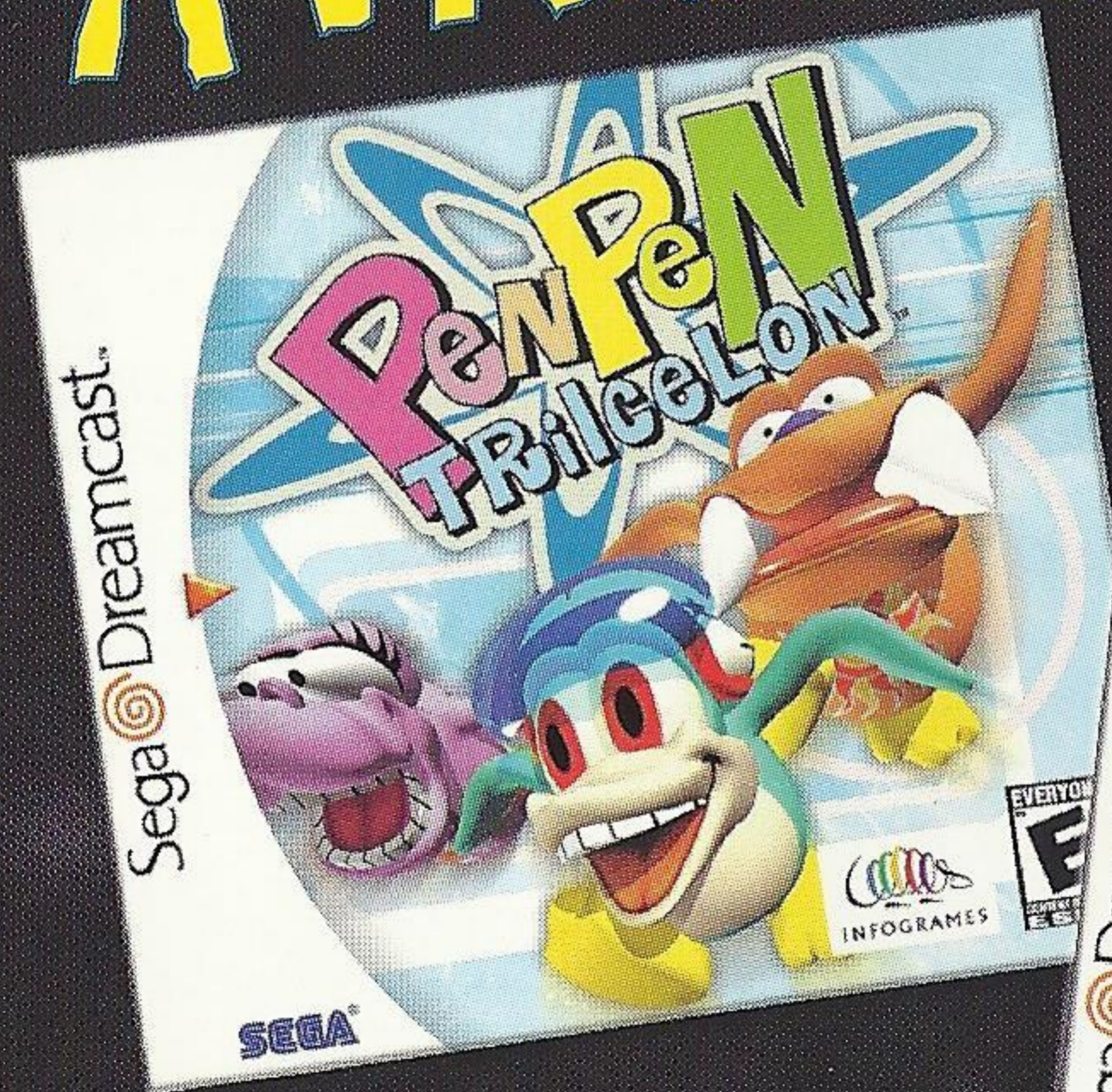

Infogrames Entertainment S.A. 5300 Stevens Creek Blvd, Suite 500 San Jose, Ca 95129

Test Drive, V-Rally and Infogrames are the trademarks or registered trademarks of Infogrames Entertainment S.A. Test Drive V-Rally © 2000 Infogrames Entertainment S.A. All Rights Reserved. Sega is registered in the US Patent and Trademark Office. Sega Dreamcast, the Dreamcast Swirl, are trademarks of SEGA. Sega of America, P.O. Box 7639, San Francisco, CA 94120. The ratings icon is a trademark of the Interactive Digital Software Association. All other trademarks and trade names are the properties of their respective owners. Programmed in Japan. Made and printed in the USA. WARNING: Operates only with NTSC televisions and Sega Dreamcast systems purchased in North and South America (except Argentina, Paraguay and Uruguay). Will not operate with any other televisions or Sega Dreamcast systems. Product covered under one or more of the following U.S. Patents: 5,460,374; 5,525,770; 5,627,895; 5,688,173; 4,442,486; 4,454,594; 4,462,076; Re. 35,839; Japanese Patent No.2870538, (Patents pending in U.S. and other countries); Canada Patent No. 1,183,276.

