

# SEGA SUPERSTARS tennis



SEGA®

## PRECAUTIONS

- This disc contains software for the PLAYSTATION®3 system. Never use this disc on any other system, as it could damage it.
- This disc conforms to PLAYSTATION®3 specifications for the PAL market only. It cannot be used on other specification versions of PLAYSTATION®3.
- Read the PLAYSTATION®3 system Instruction Manual carefully to ensure correct usage.
- When inserting this disc in the PLAYSTATION®3 system always place it with the required playback side facing down.
- When handling the disc, do not touch the surface. Hold it by the edge.
- Keep the disc clean and free of scratches. Should the surface become dirty, wipe it gently with a soft dry cloth.
- Do not leave the disc near heat sources or in direct sunlight or excessive moisture.
- Do not use an irregularly shaped disc, a cracked or warped disc, or one that has been repaired with adhesives, as it could lead to malfunction.

## HEALTH WARNING

Always play in a well lit environment. Take regular breaks, 15 minutes every hour. Discontinue playing if you experience dizziness, nausea, fatigue or have a headache. Some individuals are sensitive to flashing or flickering lights or geometric shapes and patterns, may have an undetected epileptic condition and may experience epileptic seizures when watching television or playing videogames. Consult your doctor before playing videogames if you have an epileptic condition and immediately should you experience any of the following symptoms whilst playing: altered vision, muscle twitching, other involuntary movement, loss of awareness, confusion and/or convulsions

## PIRACY

The unauthorised reproduction of all or any game part of this product and the unauthorised use of registered trademarks are likely to constitute a criminal offence. Piracy harms consumers as well as legitimate developers, publishers and retailers. If you suspect this game product is an unauthorised copy, or have any other information about pirate product, please call your local Customer Service number given at the back of this manual.

## PAN EUROPEAN GAMES INFORMATION (PEGI) AGE-RATING SYSTEM

The PEGI age-rating system protects minors from games unsuitable for their particular age group. PLEASE NOTE it is not a guide to gaming difficulty. Comprising three parts, PEGI allows parents and those purchasing games for children to make an informed choice appropriate to the age of the intended player. The first part is an age rating:-



The second is icons indicating the type of content in the game. Depending on the game, there may be a number of such icons.



VIOLENCE



BAD LANGUAGE



FEAR



SEXUAL CONTENT



DRUGS



DISCRIMINATION



GAMBLING

The age rating of the game reflects the intensity of this content. The icons are:-



The third is an icon indicating the game can be played online. This icon may be used only by online game providers who have committed to uphold standards which include the protection of minors in online gameplay:-

For further information visit  
<http://www.pegi.info>

BLES-00232 MAN-B00232-UK

See back page of this manual for Customer Service Numbers.

## SYSTEM SOFTWARE UPDATE



For details about how to perform System Software updates for the PLAYSTATION®3 system, visit [eu.playstation.com/ps3](http://eu.playstation.com/ps3) or refer to the PS3™ system's Quick Reference document.

## PARENTAL CONTROL

This product has a preset Parental Control Level based on its content. You can set the Parental Control Level on the PLAYSTATION®3 system to restrict the playback of a product with a Parental Control Level that is higher than the level set on the PS3™ system. For more information, please refer to the PS3™ system Instruction Manual.

This product is classified according to the PEGI rating system. The PEGI rating marks and content descriptors are displayed on the product package (except where, by law, another rating system applies). The relationship between the PEGI rating system and the Parental Control Level is as follows:

PARENTAL CONTROL LEVEL	PEGI RATING AGE GROUP
9	18+
7	16+
5	12+
3	7+
2	3+

FOR HOME USE ONLY: This software is licensed for play on authorised PLAYSTATION®3 systems only. All unauthorised access, use or transfer of the product or its underlying copyright and trademark works is prohibited. See [eu.playstation.com/terms](http://eu.playstation.com/terms) for full usage rights. Library programs ©1997-2008 Sony Computer Entertainment Inc. exclusively licensed to Sony Computer Entertainment Europe (SCEE). RESALE AND RENTAL ARE PROHIBITED UNLESS EXPRESSLY AUTHORISED BY SCEE. Broadband internet service and PLAYSTATION®Network account required. PLAYSTATION®Network is subject to terms of use and may not be available, see [eu.playstation.com/terms](http://eu.playstation.com/terms). Players under 18 require parental consent. Licensed for sale only in Europe, the Middle East, Africa and Oceania.

™, "PLAYSTATION" and "PS3" are trademarks or registered trademarks of Sony Computer Entertainment Inc. "Blu-ray Disc" and "BD" are trademarks.  
© SEGA. SEGA, the SEGA logo, SEGA Superstars and SEGA Superstars Tennis are either registered trademarks or trademarks of SEGA Corporation. Published by SEGA.  
Developed by SUMO Digital. Made in Austria. All rights reserved.

Thank you for purchasing SEGA SUPERSTARS™ TENNIS. Please note that this software is designed only for use with the PLAYSTATION®3 system. Be sure to read this instruction booklet thoroughly before you start playing.



## CONTENTS

GETTING STARTED .....	1
CONTROLS .....	3
STARTING THE GAME .....	7
SUPERSTARS .....	8
MATCH .....	10
TOURNAMENT .....	11
GAMES .....	12
OPTIONS .....	13
WARRANTY .....	25
PRODUCT SUPPORT .....	26



# GETTING STARTED

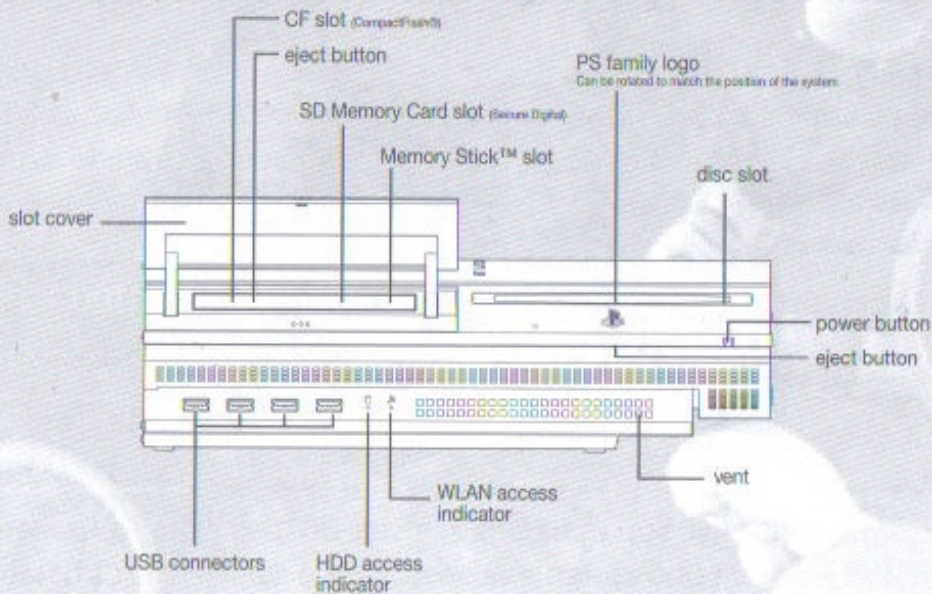

## STARTING A GAME

Before use, carefully read the instructions supplied with the PLAYSTATION®3 system. The documentation contains information on setting up and using your system as well as important safety information.

Check that the MAIN POWER switch (located on the system rear) is turned on. Insert SEGA SUPERSTARS™ TENNIS disc with the label facing up into the disc slot. Select the icon for the software title under [Game] in the PLAYSTATION®3 Home Menu, and then press **X**. Refer to this manual for information on using the software.

## QUITTING A GAME

During gameplay, press the PS button on the wireless controller and then select "Quit Game" from the screen that is displayed.

**Hint:** To remove a disc, touch the eject button after quitting the game.

While playing, if you remove the game disc the game will end and you will be returned to the System Software Screen, any unsaved progress will be lost.



Note: To use the controller, you must first register or “pair” the controller with the PLAYSTATION®3 system and assign a number to the controller. For details, refer to the Instructions supplied with the system.

### **SAVED DATA FOR PLAYSTATION®3 FORMAT SOFTWARE**

Saved data for PLAYSTATION®3 format software is saved on the system’s hard disk. The data is displayed under “Saved Game Utility” in the Game menu.

### **AUTO SAVE**

This title uses an autosave feature. Saved data is saved automatically at certain points. Do not switch off the power when the HDD access indicator is flashing.

The following controls are used in this game. Please note that all explanations assume A type configuration. Configuration can be changed via Options (p.13) and the Pause Menu.

	Menu Controls:	Game Controls:
Directional buttons / left stick	Highlight menu item Change Option	Player movement
⊗ button	Select / Open Menu	
⊙ button	Cancel / Exit Menu	
⊗ button	Not used	Topspin
⊙ button	Not used	Slice
⊗ then ⊙ button	Not used	Lob
⊙ then ⊗ button	Not used	Dropshot
⊗ or ⊙ button	Not used	Smash (Ball is above player)
<b>L1</b> / <b>R1</b> buttons START button SELECT button	Not used	Superstar State Pause Change View

# VIEWING THE GAME SCREEN

Player / COM information



Points

Serve Speed

## BASIC TECHNIQUES

### SERVE:

To serve, toss the ball into the air by pressing the  $\otimes$  button. Then simply press again to serve! If you want to aim your shot, use the left stick.



### SHOT STRENGTH:

The power with which the player hits a shot is determined by the player's position. To strike a more powerful shot, the player should prepare for the shot by moving into a good position on court ready to return it.







### **BALL DIRECTION:**

When striking a ball, the player can control the direction of the shot using the left stick.





### **SMASH:**

When a high ball is delivered the 'Smash Chance' marker will appear. Move quickly to it, and play a shot with the  or  buttons to deliver a smash.



### **DROP SHOT:**

When the player hits a drop shot, the ball falls gently just over the net. This makes it a handy option for times when the opponent is at the back of the court. To perform a drop shot just press the  button, immediately followed by the  button.



## SUPERSTAR STATE



Every player has a Superstar meter in the form of a star beneath their feet, which is slowly filled whenever the player performs well. When this star is filled, the player can transform into their Superstar State! Superstar State is triggered by pressing either of the **L1** or **R1** buttons.

Every character has their own unique special Superstar State. While the player is in their state, they run faster, hit the ball harder, or even call down the power of the skies! Each characters powers are different, so try them all!



Press the START button at the Title Screen to bring up the Main Menu, and use the directional buttons and the **X** button to select from the following modes:

## PLANET SUPERSTARS

PLANET SUPERSTARS allows a single player to take on over 100 challenges, visiting some of SEGA's most recognized worlds, and meeting some familiar and well loved names along the way. Challenges include tournaments, ballgames, special events and more, and allow the player to unlock additional content.

## MATCH

A player designed match for between 1 and 4 players. The court and all game settings can be decided by the players.

## TOURNAMENT

Play alone or with a friend in a sequence of matches against randomly selected computer opponents. Tournament Mode comprises 5 singles matches, or 3 doubles matches.

## GAMES

A collection of 8 fun new games based around famous SEGA titles! Play single player or upto four person multiplayer.

## OPTIONS

Modify game options and view records.

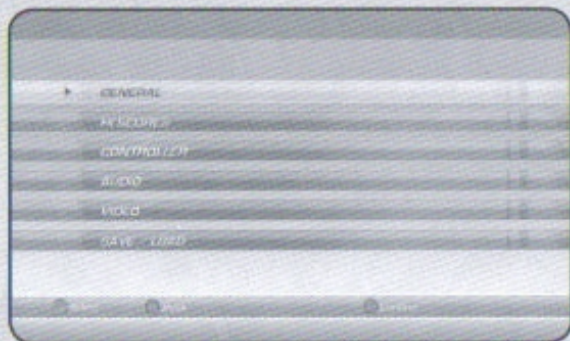

# SUPERSTARS

Superstars allows a single player to compete in over 100 challenges including exhibition matches, tournaments and party games, to unlock additional characters, courts, games, music and other content.





## SUPERSTARS

The player can navigate around the SUPERSTARS Map using the left stick . The map contains a number of game zones, each representing a famous SEGA title. Game zones are represented on the SUPERSTARS Map as logos. Pressing the  button will take the player into the chosen game zone, where they will be presented with further information and shown available challenges. Game zones that are presently locked will appear as question marks.

## SEGA GAME ZONES

Within each Sega Game Zone there are a list of challenges available within the zone. The player is also shown whether challenges will provide them with unlockable content, and the conditions they must achieve to gain that content.

The player can navigate the zone menu using the left stick and select a challenge by pressing the  button while the desired challenge is selected. The player can press the  button to return to the SUPERSTARS Map.

If the player has already attempted to complete a challenge, their previous rank will be displayed beside the challenge details. If a prize available for a challenge has already been unlocked, the prize will be displayed.

## CHALLENGES

When taking on challenges within a Game Zone, the player will have the opportunity to play special exhibition matches, whole tournaments and a host of unique party games, each tailored to the particular game zone the player has entered. The player will be presented with any detailed gameplay instructions or objectives via an on screen message before a challenge begins.

# MATCH

Match games may be organized for between 1 and 4 players, and can take place on any unlocked courts, and using any unlocked players. The player may also select from a range of other options including number of games, number of sets and more.



The player navigates between available characters on the character select screen, using the directional buttons or left stick. Pressing the **X** button will select the highlighted character and the **O** button will return the player to the previous screen.

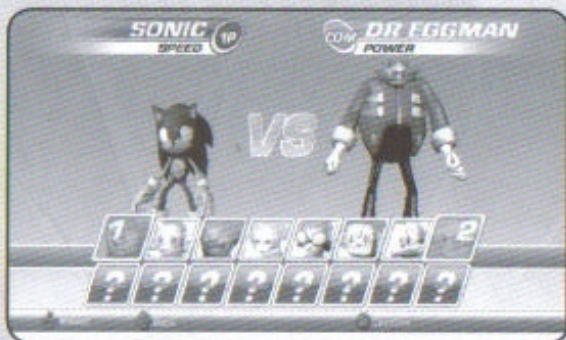

Once all players have selected their character, the players appear beside court, and can then place their characters in the desired position on court using the directional buttons to move and the **X** button to confirm their position. The player can return to the character select screen by pressing the **O** button.

After all players have selected their characters and positions, the player is given a selection of advanced options, including court, number of games, difficulty etc. The player navigates this list and toggles the options using the directional buttons. Once the options have been set to the players satisfaction, the **X** button will confirm the selection. Pressing the **O** button will return the player to the Position Select screen.

# TOURNAMENT

In Tournament mode, the player may play a sequence of Singles or Doubles matches, competing alone or with a friend against increasingly difficult COM opponents to finally claim the title of SEGA Superstars Champion!

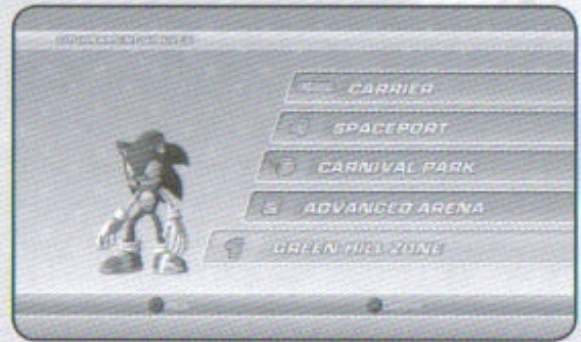

The player navigates between available characters on the character select screen, using the directional buttons. Pressing the **X** button will select the highlighted character and the **Y** button will return the player to the previous screen.

Once the player(s) have selected their character, a stage display screen will appear, showing the current stage reached. The player may continue from this screen by pressing the **X** button.



## GAMES

Games Mode allows the player to play singleplayer or with their friends in a series of games that can be unlocked within Planet Superstars.



After selecting Single or Multiplayer, the player is taken to a screen displaying available games. The player may navigate this menu using the directional buttons and select their desired game by pressing the  $\times$  button. The player can return to the main menu by pressing the  $\odot$  button.



On selecting a game, the player will be given any specific instructions or objectives relating to the particular game.



Make changes to a variety of game settings as detailed below. Use the directional buttons to select a category, and press the **X** button to open the settings. When settings are open, use the directional buttons to select an option, and press the **X** button to make changes. Press **○** button when finished to return to the Main Menu.



## Settings:

### General

- **Difficulty**
- **Superstar Mode**
- **Fix Camera**
- **Speed**

### High Scores

### Controller

- **Controller Type**

### Audio

- **Music Volume**
- **Sound Effects Volume**

### Video

- **Brightness**

### Save / Load

- **Autosave**
- **Save**
- **Load**

## Records:

On the records screen, the player may view saved high scores and statistics relating to their previous gameplay.

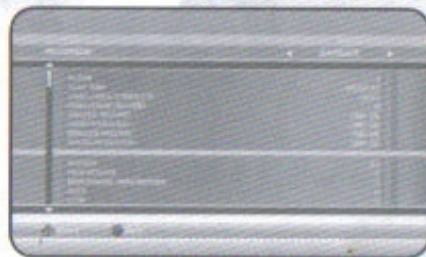

## VARNING!

• Denna skiva innehåller programvara avsedd för PLAYSTATION®3-systemet. Använd aldrig skivan i andra system eftersom skivan då kan skadas. • Skivan följer enbart PLAYSTATION®3-specifikationerna för PAL-marknaden. Den kan inte användas på PLAYSTATION®3-system som följer andra specifikationer. • Läs noggrant igenom dokumentationen till ditt PLAYSTATION®3-system så att du använder systemet på ett korrekt sätt. • Placera alltid skivan med etiketten uppåt när du sätter in den i ditt PLAYSTATION®3-system. • Vidrör inte skivans yta när du hanterar den. Håll i skivans kanter. • Håll skivan ren och repa den inte. Om ytan är smutsig torka du försiktigt av den med en mjuk och torr trasa. • Placera inte skivan i närheten av värmekällor, i direkt solljus eller i fuktiga miljöer. • Använd inte en skiva om den är oval, om den innehåller sprickor eller om den har reparerats med självhäftande material, eftersom det kan orsaka skador.

## HÄLSOVARNING

Spela alltid i en väl upplyst miljö. Ta regelbundna pauser, cirka 15 minuter varje timme. Avbryt spelet om du känner dig yr, illamående, trött eller har huvudvärk. Vissa personer är känsliga för blinkande/flimrande ljus och geometriska former/mönster och kan ha epileptiska anlag utan att det har upptäckts, vilket kan leda till att de drabbas av epileptiska anfall när de tittar på TV eller spelar TV-spel. Kontakta en läkare innan du spelar TV-spel om du lider av epilepsi, och omedelbart om du upplever några av följande symptom när du spelar: Synförändringar, muskelsammandragningar, andra ofrivilliga rörelser, yrsel, förvirring och/eller krampanfall.

## OLOVLIG KOPIERING

Olovlig reproducering av hela eller delar av denna produkt och otillåten användning av registrerade varumärken är ett brott mot svensk och internationell lagstiftning. Olovlig kopiering skadar både konsumenter och seriösa utvecklare, utgivare och återförsäljare. Om du misstänker att du har en otillåten kopia av denna spelprodukt, eller om du har någon annan information om otillåtet kopierade produkter, ber vi dig kontakta din lokala kundtjänst. Du hittar numret på baksidan av den här manualen.

## ÅLDERSMÄRKNINGSSYSTEMET PEGI (PAN EUROPEAN GAMES INFORMATION)

Syftet med åldersmärkningssystemet PEGI är att skydda minderåriga från spel som inte är lämpliga för en viss åldersgrupp. Obs! Det är alltså ingen klassificering av spelets svårighetsgrad. PEGI-systemet omfattar tre delar som tillsammans gör det lättare för föräldrar och andra som köper spel till barn, att fatta ett välgrundat beslut utifrån barnets ålder. Den första delen är en åldersmärkning:



Den andra delen utgörs av ikoner som visar vilken typ av innehåll spelet har. Det kan finnas flera sådana ikoner, beroende på vilket spel det handlar om. Spelets åldersmärkning återspeglar hur våldsamt innehållet är. Följande ikoner används:



VÅLDSAMT  
INNEHÅLL



GROVT SPRÅK



SKRÄMMANDE  
INNEHÅLL



SEXUELLT  
INNEHÅLL



DROGRELATERAT  
INNEHÅLL



DISKRIMINERANDE  
INNEHÅLL



HASARDSPEL

Den tredje delen är en ikon som visar om spelet kan spelas online. Denna ikon användas bara av onlinespelsleverantörer som har förbundit sig att upprätthålla vissa standarder, t.ex. för skydd av minderåriga i onlinespel:



Mer information får du genom att besöka  
<http://www.pegi.info>

Du hittar telefonnumret till vår kundtjänst på baksidan av den här manualen.



För information om hur man uppdaterar systemprogramvaran till ditt PLAYSTATION®3-system, gå in på [eu.playstation.com/ps3](http://eu.playstation.com/ps3) eller använd PS3™-systemets medföljande Snabbhandledning.

## BARNLÅSFUNKTION

Den här produkten har en förinställd barnläsnivå baserad på dess innehåll. Du kan ange barnläsnivån på PLAYSTATION®3 så att det inte går att spela upp en produkt med en barnläsnivå som överstiger den angivna nivån på PS3™-systemet. Mer information hittar du i dokumentationen till ditt PS3™-system.

Denna produkt är klassificerad enligt åldersmärkningssystemet PEGI. Både PEGI-nivån och en beskrivning av innehållet finns på förpackning (såvida inte gällande lagstiftning kräver att ett annat klassificeringssystem används). Följande tabell visar förhållandet mellan PEGI-nivån och barnläsnivån:

NIVÅ PÅ INNEHÅLLSFILTER	PEGI:S REKOMMENDERADE ÅLDER
9	18+
7	16+
5	12+
3	7+
2	3+

ENDAST FÖR HEMMABRUK: Denna programvara är licensierad för spel på auktoriserade PLAYSTATION®3-system endast. All obehörig åtkomst, användning eller överlåtelse av produkten eller dess underliggande verk som skyddas av copyright och varumärken är förbjuden. Fullständig information om användarrättigheter finns på <http://eu.playstation.com/terms>. Library programs ©1997-2008 Sony Computer Entertainment Inc. endast licensierad till Sony Computer Entertainment Europe (SCEE). ÅTERFÖRSÄLJNING OCH UTHYRNING ÄR FÖRBJUDET UTAN UTTRYCKLIGT TILLSTÅND FRÅN SCEE. Internetanslutning via bredband och PLAYSTATION®Network-konto krävs. PLAYSTATION®Network omfattas av användarvillkor och är eventuellt inte tillgängligt. Se <http://eu.playstation.com/terms>. Spelare under 18 år måste ha tillstånd från en förälder. Licensierad för försäljning i Europa, Mellanöstern, Afrika och Oceanien endast.

"PS", "PLAYSTATION" and "PS3" are trademarks or registered trademarks of Sony Computer Entertainment Inc. "Blu-ray Disc" and "BD" are trademarks.  
 © SEGA SEGA, the SEGA logo, SEGA Superstars and SEGA Superstars Tennis are either registered trademarks or trademarks of SEGA Corporation. Published by SEGA.  
 Developed by SUMO Digital. Made in Austria. All rights reserved.

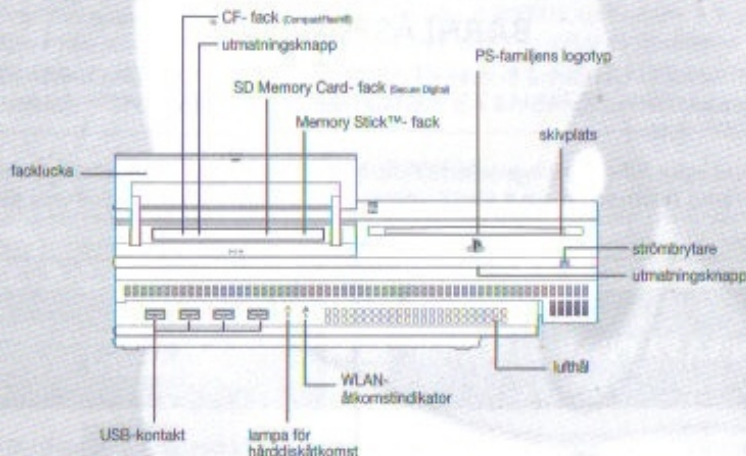
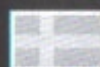

## KONFIGURATION

Konfigurera PLAYSTATION®3-systemet enligt instruktionerna i instruktionsboken. När PLAYSTATION®3-systemet startas lyser I/Ⓞ-indikatorn rött vilket indikerar att systemet är i Standby-läge. Tryck på I/Ⓞ/RESET-knappen så att I/Ⓞ-indikatorn lyser grönt.

Sätt in SegaSuperstarsTennis™ - skivan med etiketten uppåt i skivplatsen. Välj -ikonen på huvudmenyn. En miniatyrbild av programvaran visas. Tryck på -knappen för att starta inläsningen. Sätta inte in eller ta bort tillbehör när strömmen är påslagen.



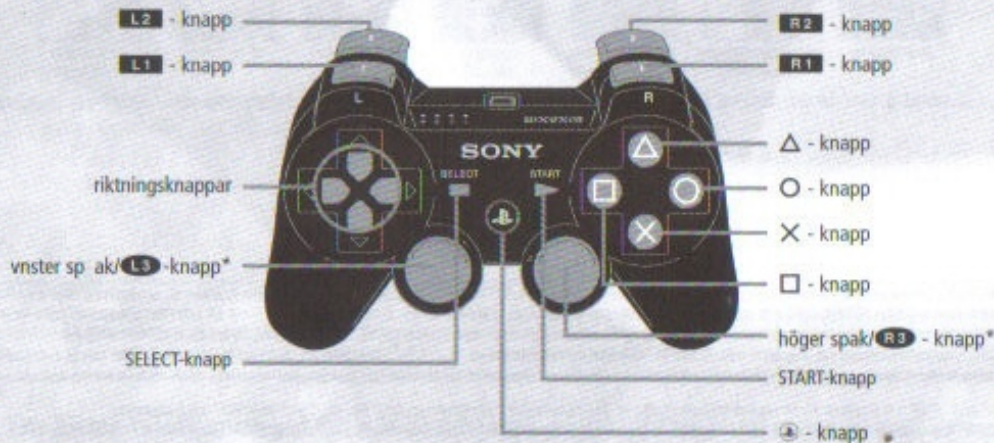

SegaSuperstarsTennis™ - stöder bara Trådlös Handkontroll SIXAXIS™. Mer information om hur du konfigurerar och laddar en trådlös handkontroll hittar du i instruktionsboken till ditt PLAYSTATION®3-system.

**Obs!** Informationen i den här manualen var korrekt vid det tillfälle då den trycktes. Mindre förändringar kan ha gjorts under de sista faserna i utvecklandet av produkten. Alla skärmbilder i manualen är hämtade från den engelska versionen av produkten.

## ANVÄNDA DEN TRÅDLÖSA SIXAXIS™-KONTROLLEN



### **SERVA:**

När du vill serva trycker du på -knappen för att kasta upp bollen i luften. Tryck sedan på -knappen igen för att slå serven! Om du vill sikta använder du vänster analog spak. Om du vill slå en lurig underarmsserve för du ner vänster analog spak och slår serven som en stoppboll (tryck först på -knappen och direkt efter på -knappen).



### **SLAGSTYRKA:**

Din slagstyrka avgörs av hur bra du lyckas stå placerad på spelplanen. Om du vill slå ett extra kraftfullt slag måste du stå rätt placerad när bollen kommer.



### **SLAGRIKTNING:**

När du slår till bollen kan du styra slagriktningen med vänster analog spak.

### **SMASHA:**

Om motståndaren slår en lobb visas en smashmarkör. Gå till den och smasha genom att trycka på - eller -knappen.

### **SLÅ STOPPBOLL:**

Om du slår en stoppboll kommer den att landa precis invid nätet på motspelarens planhalva. Det är ett effektivt vapen om motspelaren står långt ner bakom baslinjen. Slå en stoppboll genom att först trycka på -knappen och direkt efter på -knappen.

## **Superstjärna**

Varje spelare har en mätare under fötterna i form av en stjärna. Ju bättre du spelar desto mer fylls stjärnan i. När stjärnan är helt ifylld kan du bli lika skicklig som en superstjärna! Du startar superstjärneläget genom att trycka antingen på **L1**- eller **R1**-knappen. Varje spelfigur har unika superförmågor. När din spelare är i superstjärneläge springer han snabbare, slår hårdare eller kan påkalla högre makter! Du måste prova alla spelfigurer eftersom ingen är den andre lik!

## VAROTOIMENPITEET

• Tämä levy sisältää PLAYSTATION®3-järjestelmälle tarkoitettun ohjelmiston. Älä koskaan käytä tätä levyä muussa järjestelmässä, sillä tämä saattaa johtaa levyn vahingoittumiseen. • Tämä levy toimii vain PAL-standardin kanssa yhteensopivissa PLAYSTATION®3-järjestelmissä. Tätä levyä ei voi käyttää muissa PLAYSTATION®3-järjestelmän versioissa. • Lue PLAYSTATION®3-järjestelmän käyttöohje huolellisesti ennen laitteen käyttöönottoa. • Aseta tämä levy PLAYSTATION®3-järjestelmän levyasemaan aina tietopuoli alaspäin. • Älä kosketa levyn pintaa käsitellessäsi sitä. Kosketa vain sen reunoja. • Pidä levy puhtaana ja vältä sen naarmuttamista. Jos levyn pinta likaantuu, pyyhi levy hellävaroin kuivalla liinalla. • Älä säilytä levyä lämmönlähteiden lähellä, suorassa auringonvalossa tai kosteissa tiloissa. • Älä koskaan käytä poikkeavan muotoista, murtunutta, vääntynyttä tai liima-aineilla korjattua levyä, sillä tämä saattaa johtaa järjestelmän vaurioitumiseen.

## TERVEYSVAROITUS

Pelaa aina hyvin valaistussa tilassa. Pidä taukoja säännöllisesti, 15 minuuttia jokaisen tunnin jälkeen. Lopeta pelaaminen, jos tunnet huimausta, pahoinvointia, uupumusta tai päänsärkyä. Ihmiset, jotka ovat herkkiä välähdyksille, vilkkuville valoille tai geometrisille muodoille ja kuvioille, voivat sairastaa pillevää epilepsiaa ja voivat saada kohtauksen katsoessaan televisiota tai pelatessaan videopelejä. Ota yhteyttä lääkäriin ennen videopelien pelaamista, jos sinulla on diagnosoitu epilepsia. Lopeta pelaaminen heti, jos sinulla on oireita: huimaus, näköharhat, lihaskrampit, muut hallitsemattomat liikkeet, sekavuus, keskittymishäiriöt ja/tai kouristukset.

## PIRATISMI

Tämän pelin tai sen osan luvaton kopioiminen tai rekisteröityjen tavaramerkkien luvaton käyttäminen voivat johtaa rikossyytteen. PIRATISMI tuottaa vahinkoa niin kuluttajille kuin ohjelmiston kehittäjille, julkaisijoille ja jälleenmyyjille. Jos epäilet, että olet saanut haltuusi pelin luvattoman kopion, tai jos sinulla on tietoa piraattituotteesta, ota yhteyttä asiakaspalveluun soittamalla tämän ohjekirjan lopussa olevaan numeroon.

## PAN EUROPEAN GAMES INFORMATION (PEGI) - IKÄLUOKITUSJÄRJESTELMÄ

PEGI-ikäluokitusjärjestelmä suojelee alaikäisiä peleiltä, jotka eivät ole sopivia heidän ikäryhmälleen. HUOMAA, että tämä ei viittaa pelin vaikeustasoon. Kolmesta osasta koostuvan PEGI-järjestelmän avulla lasten vanhemmat ja muut lapsille pelejä ostavat henkilöt voivat valita lapselle sopivan pelin. Ensimmäinen osa on ikärajoitus:-



Toinen osa koostuu pelin sisältöä kuvaavista kuvakkeista. Pelistä riippuen kuvakkeita voi olla enemmän kuin yksi. Pelin ikäraja kuvastaa kyseessä olevan pelin sisällön laatua. Kuvakkeet ovat:-



VÄKIVALTA



KIROILU



KÄSI



SEKSI



HUUMEET



SYRJINTÄ



ULKAPELEJÄ

Kolmas osa on verkkopelimahdollisuudesta kertova kuvake. Tätä kuvaketta saavat käyttää vain ne verkkopelintarjoajat, jotka ovat sitoutuneet valvomaan palvelunsa sisältöä. Sitoumukseen kuuluu myös alaikäisten lasten suojeleminen:-



Lisätietoa saat osoitteesta  
<http://www.pegi.info>

Asiakaspalvelunumeromme löydät tämän ohjekirjan takakannesta.

# JÄRJESTELMÄOHJELMISTO-PÄIVITYKSET



Saat lisätietoja PLAYSTATION®3-järjestelmän Järjestelmäohjelmisto-päivitysten suorittamisesta osoitteesta [eu.playstation.com/ps3](http://eu.playstation.com/ps3) tai PS3™-järjestelmän kohdasta Pikaopas.

## SISÄLLÖNSUODATUS

Tälle tuotteelle on määritelty sisällönsuodatuksen taso tuotteen sisällön perusteella. Voit määrittää PLAYSTATION®3-järjestelmään sisällönsuodatuksen tason, joka estää tuotteen käyttämisen, jos sen taso on korkeampi kuin PS3™-järjestelmän taso. Lisätietoja sisällönsuodatuksen määrittämisestä saat PS3™-järjestelmän käyttöohjeesta.

Tämä tuote on luokiteltu PEGI-järjestelmän mukaisesti. PEGI-järjestelmän merkit ja sisällön laadun kuvaukset on painettu tuotepakettiin (pois lukien maat, joissa käytetään toista ikäluokitusjärjestelmää). Sisällönsuodatuksen tasot vastaavat PEGI-järjestelmän luokituksia seuraavalla tavalla:

SISÄLLÖNSUODATUKSEN TASO	PEGI-ikäLUOKITUS
9	18+
7	16+
5	12+
3	7+
2	3+

**VAIN YKSITYISKÄYTTÖÖN:** Tämän ohjelman käyttölisenssi oikeuttaa sen käytön vain valtuutetuilla PLAYSTATION®3-järjestelmissä. Tämän tuotteen, sen tekijänoikeuksien tai tuotemerkin kattavien teoksien valtuuttamaton käyttö tai siirto on kielletty. Käyttöoikeudet kokonaisuudessaan löytyvät nettiosoitteesta <http://eu.playstation.com/terms>. Library programs ©1997-2006 Sony Computer Entertainment Inc. ja niiden yksinomainen käyttöoikeuksien haltija on Sony Computer Entertainment Europe (SCEE). JÄLLEENMYynti JA VUOKRAUS ON KIELLETTY ILMAN SCEE: N ERITYISTÄ LUPAA. Käyttövaatimukset: Laajakaistan internet-yhteys ja PLAYSTATION®Network-BILI. PLAYSTATION®Network-verkon käyttö tapahtuu sen käyttöehtojen mukaisesti, eikä sen saatavuutta taata. Tutustu käyttöehtoihin osoitteesta <http://eu.playstation.com/terms>. Alle 18-vuotiailla pelaajilla vaaditaan vanhempien suostumus. Myyntioikeudet ovat voimassa ainoastaan Euroopassa, Lähi-Idässä, Afrikassa sekä Oseaniassa.

™, "PLAYSTATION" and "PS3" are trademarks or registered trademarks of Sony Computer Entertainment Inc. "Blu-ray Disc" and "BD" are trademarks. © SEGA, SEGA, the SEGA logo, SEGA Superstars and SEGA Superstars Tennis are either registered trademarks or trademarks of SEGA Corporation. Published by SEGA. Developed by SUMO Digital. Made in Austria. All rights reserved.

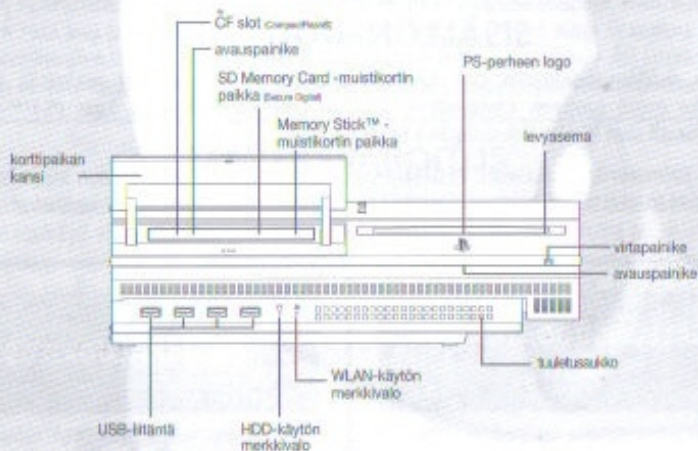

## VALMISTELUT

Valmistele PLAYSTATION®3-järjestelmä sen käyttöohjeen neuvomalla tavalla. Ennen käynnistystä järjestelmän I/O-merkkivalo palaa punaisena merkiksi siitä, että PLAYSTATION®3-järjestelmä on valmiustilassa. Paina I/O/RESET-näppäintä, jonka jälkeen I/O-merkkivalo palaa vihreänä.

Aseta SegaSuperstarsTennis™ - levy levyasemaan tekstipuoli ylöspäin. Valitse Kotivalikosta -kuvake. Ruudulle ilmestyy kuva ohjelmistosta. Paina X-näppäintä käynnistääksesi lataamisen. Älä kiinnitä tai irrota lisälaitteita, kun virta on päällä.

SegaSuperstarsTennis™ - tukee vain langatonta SIXAXIS™-ohjainta. Lisätietoja langattoman ohjaimen asentamisesta ja lataamisesta löydät PLAYSTATION®3-järjestelmän käyttöohjeesta.

**HUOMAUTUS:** Tässä ohjekirjassa oleva tieto on tarkistettu ennen sen painamista. Tuotteeseen on kuitenkin saatettu tehdä pieniä muutoksia painamisen jälkeen. Kaikki näyttörüutokuvat on otettu tuotteen englanninkielisestä versiosta.

## LANGATTOMAN SIXAXIS™-OHJAIMEN (PLAYSTATION®3)

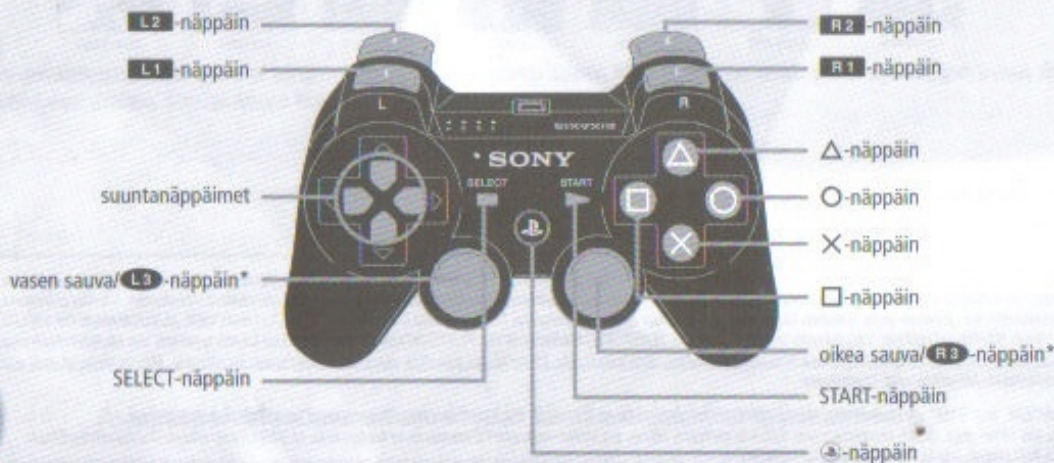



## **SYÖTTÖ:**

Kun syötät, heitä ensin pallo ilmaan painamalla ⊗-näppäintä. Sitten voit syöttää painamalla uudelleen ⊗-näppäintä. Jos haluat tähdätä syötön, tee se vasemmalla sauvalla. [Juonikkaan alasyötön voi tehdä vetämällä vasenta sauvaa alaspäin ja iskemällä syötön pysäytyslyöntinä (ensin ⊙- ja sitten ⊗-näppäin)]

## **LYÖNNIN VOIMA:**

Lyönnin voima määräytyy pelaajan sijainnin perusteella. Pelaaja saa lyöntiin lisävoimaa valmistautumalla siihen siirtymällä kentällä hyvään palautusasemaan.

## **PALLON SUUNTA**

Palloa lyödessään pelaaja voi hallita iskun suuntaa vasemmalla sauvalla.

## **ISKULYÖNTI:**

Kun vastustaja lyö korkean pallon, näkyviin tulee "Smash Chance" (iskun paikka) -merkki. Siirry nopeasti sen luo ja iske painamalla ⊗- tai ⊙-näppäintä.

## **PYSÄYTYSLYÖNTI:**

Pysäytyslyönnissä pallo putoaa hitaasti juuri ja juuri verkon yli. Se on kätevä vaihtoehto, kun vastustaja on takakentällä. Voit tehdä pysäytyslyönnin painamalla ensin ⊙-näppäintä ja heti sen jälkeen ⊗-näppäintä.

## **Supertähtitila**

Jokaisella pelaajalla on Supertähtimittari, joka näkyy tähtenä pelaajan jalkojen alla. Tähti täyttyy hitaasti, kun pelaaja pelaa hyvin. Kun tähti on täyttynyt, pelaaja voi siirtyä Supertähtitilaansa! Supertähtitila käynnistetään painamalla jotakin seuraavista näppäimistä: **L1** ja **R1**. Jokaisella hahmolla on oma erityinen Supertähtitilansa. Kun pelaaja on tilassaan, hän juoksee nopeammin, iskee palloa kovemmin ja voi jopa kutsua alas taivaan mahdin! Jokaisella hahmolla on erilaiset voimat, joten jokaista kannattaa kokeilla!

# WARRANTY

**WARRANTY:** SEGA Europe Limited warrants to you, the original purchaser of the Game, that this Game will perform substantially as described in the accompanying manual for a period of 90 days from the date of first purchase. If you discover a problem with the Game covered by this warranty within the 90-day period, your retailer will repair or replace the Game at its option, free of charge, according to the process identified below. This limited warranty: (a) does not apply if the Game is used in a business or for a commercial purpose; and (b) is void if any difficulties with the Game are related to accident, abuse, virus or misapplication. This limited warranty gives you specific rights, and you may also have statutory or other rights under your local jurisdiction.

**RETURNS WITHIN A 90 DAY PERIOD:** Warranty claims should be made to the retailer from where you bought the game. Return the Game together with a copy of the original sales receipt and an explanation of the difficulty you are experiencing with the Game. At its option, the retailer will either repair or replace the Game. Any replacement Game will be warranted for the remainder of the original warranty period or 90 days from receipt, whichever is longer. If for any reason the Game cannot be repaired or replaced, you will be entitled to receive your direct (but no other) damages incurred in reasonable reliance but only up to the amount of the price you paid for the Game. The foregoing (repair, replacement or limited damages) is your exclusive remedy.

**LIMITATIONS:** TO THE FULL EXTENT ALLOWED BY LAW, NEITHER SEGA EUROPE LIMITED, ITS RETAILERS OR SUPPLIERS ARE LIABLE FOR ANY SPECIAL, INCIDENTAL, PUNITIVE, INDIRECT OR CONSEQUENTIAL DAMAGES ARISING FROM THE POSSESSION, USE OR MALFUNCTION OF THIS GAME.

Information in this document, including URL and other Internet Web site references, is subject to change without notice. Unless otherwise noted, the example companies, organisations, products, people and events depicted in the game are fictitious and no association with any real company, organisation, product, person or event is intended or should be inferred. Complying with all applicable copyright laws is the responsibility of the user. Without limiting the rights under copyright, no part of this document may be reproduced, stored in or introduced into a retrieval system, or transmitted in any form or by any means (electronic, mechanical, photocopying, recording, or otherwise), or for any purpose, without the express written permission of SEGA Europe Limited.

**NOTE:** the information contained in this manual was correct at the time of printing, however some changes may have occurred towards the end of the product's development.

© SEGA. SEGA and the SEGA logo are either registered trademarks or trademarks of SEGA Corporation. All rights are reserved. Without limiting the rights under copyright, unauthorised copying, adaptation, rental, lending, distribution, extraction, re-sale, renting, broadcast, public performance or transmissions by any means of this Game or accompanying documentation of part thereof is prohibited except as otherwise permitted by SEGA.

This product contains software technology licensed from GameSpy Industries, Inc. © 1999-2008 GameSpy Industries, Inc. GameSpy and the "Powered By GameSpy" design are trademarks of GameSpy Industries, Inc. All rights reserved.

## **"Samba De Janeiro"**

Written by Gottfried Engels, Arito Moreira and Ramon Zenker

Performed by Bellini, Courtesy of Tiger Records, Published by Universal Music-MGB Songs obo Edition God's Heaven/Arabella Musikverlag GmbH, Good Morning Music (ASCAP), Upright Songs GmbH (GEMA)

## **"Al Compas Del Mambo"**

Written by Perez Prado, © 1950 EMMI, admin. by Peer International Corp. (BMI)

## **"El Bimbo"**

Written by C. Morgan, Sugar Melodi, Inc. (ASCAP)

## PRODUCT SUPPORT

Please check

**[www.sega-europe.com/support](http://www.sega-europe.com/support)**

for details of product support in your region.

Register online at **[www.sega-europe.com](http://www.sega-europe.com)** for  
exclusive news, competitions, email updates and more.



0900-737737 / [support.se@panvision.com](mailto:support.se@panvision.com)



0600-97799 (0,75€ / min + pvm)/

[tuotetuki@panvision.com](mailto:tuotetuki@panvision.com)







# Customer Service Numbers

For PLAYSTATION®3 support, visit [playstation.com](http://playstation.com)  
or refer to the telephone list below:

• **Australia** ————— **1300 365 911** —————

Calls charged at local rate. Please call these Customer Service Numbers only for hardware support of PLAYSTATION® products.

• **Österreich** ————— **0820 44 45 40** —————

0.116 Euro/Minute. Rufen Sie diese Kundendienstnummern bitte nur an, wenn Sie Hardware-Support für PLAYSTATION®-Produkte benötigen.

• **Belgique/België/Belgien** ————— **011 516 406** —————

Prix d'un appel local. Veuillez composer les numéros du service après-vente pour recevoir une assistance technique destinée uniquement aux produits PLAYSTATION®.

• **Danmark** ————— **70 12 70 13** —————

Man-Fredag 18-21; Lør-Søndag 18-21. Ring venligst kun til disse kundeservicenumre vedrørende hardware-support til PLAYSTATION®-produkter.

• **Suomi** ————— **0600-411911** —————

17.00-21.00 ma-to, 0.79 Euro/min. Tätä asiakaspalvelunumeroa voi käyttää vain PLAYSTATION®-tuotteiden laitteistotukeen liittyvissä kysymyksissä.

• **France** ————— **0820 31 32 33** —————

Prix d'un appel local - ouvert du lundi au samedi. Veuillez composer les numéros du service après-vente pour recevoir une assistance technique destinée uniquement aux produits PLAYSTATION®.

• **Deutschland** ————— **01805 766 977** —————

0,12 Euro/minute. Rufen Sie diese Kundendienstnummern bitte nur an, wenn Sie Hardware-Support für PLAYSTATION®-Produkte benötigen.

• **Ελλάδα** ————— **00 32 106 782 000** —————

Εθνική Χρέωση. Παρακαλείστε να τηλεφωνείτε σε αυτούς τους αριθμούς του Τμήματος Εξυπηρέτησης Πελατών μόνο για θέματα υιοστήριξης υλισμικού των προϊόντων PLAYSTATION®.

• **Ireland** ————— **0818 365065** —————

All calls charged at National Rate. Please call these Customer Service Numbers only for hardware support of PLAYSTATION® products.

• **Italia** ————— **199 116 266** —————

Tariffa Nazionale. Chiamare questi numeri del Servizio Clienti solamente se si necessita di assistenza relativa all'hardware dei prodotti PLAYSTATION®.

• **Malta** ————— **23 436300** —————

National Rate. Please call these Customer Service Numbers only for hardware support of PLAYSTATION® products.

• **Nederland** ————— **0495 574 817** —————

Interlokale kosten. Bel deze klantenservicenummers alleen bij hardwareproblemen met PLAYSTATION®-producten.

• **New Zealand** ————— **09 415 2447** —————

National Rate. Please call these Customer Service Numbers only for hardware support of PLAYSTATION® products.

• **Norge** ————— **81 55 09 70** —————

Mon-Fre 15-21; Lør-Søndag 12-15. Vennligst ring disse kundeservicenumrene bare for maskinvarestøtte i forbindelse med PLAYSTATION®-produkter.

• **Portugal** ————— **707 23 23 10** —————

Contacte-nos através destes números de Assistência ao Cliente para obter assistência técnica (hardware) apenas para produtos da PLAYSTATION®.

• **España** ————— **902 102 102** —————

Tarifa nacional. Al llamar a estos números del Servicio de atención al cliente sólo obtendrá asistencia para los productos PLAYSTATION®.

• **Sverige** ————— **08 587 822 25** —————

Mån-Fre 15-21, Lør-Søndag 12-15. Ring endast dessa kundeservicenummer för maskinvarusupport av PLAYSTATION®-produkter.

• **Suisse/Schweiz/Svizzera** ————— **0848 84 00 85** —————

Tarif appel national / Nationaler Tarif / Tariffa Nazionale. Veuillez composer les numéros du service après-vente pour recevoir une assistance technique destinée uniquement aux produits PLAYSTATION®.

• **UK (PLAYSTATION®Network only)** ————— **08702 42 22 99** —————

• **UK (all other enquiries)** ————— **08705 99 88 77** —————

National rate. Calls may be recorded for training purposes. Please call these Customer Service Numbers only for hardware support of PLAYSTATION® products.

# ALSO OUT ON PLAYSTATION®3



www.pegi.info

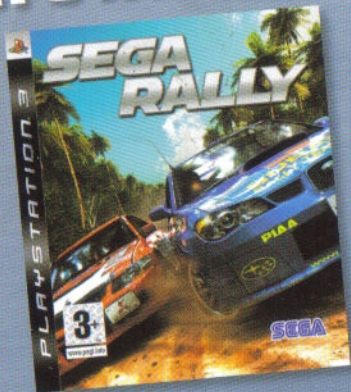

MAN-B00232-UK

SEGA®

www.sega.co.uk

SEGA®  
PASS

## REGISTER YOUR COPY OF SEGA SUPERSTARS™ TENNIS TODAY!

AND RECEIVE EXCLUSIVE ACCESS TO:

- PRIORITY DEMO PREVIEWS
- FIRST LOOK FOR VIDEOS AND MINI GAMES
- BETA GAME TESTING
- LATEST GAMING NEWS AND MUCH MORE...



REGISTER FREE NOW AT [WWW.SEGA.CO.UK/REGISTER](http://WWW.SEGA.CO.UK/REGISTER)

BLES-00232

™, "PLAYSTATION", "PS3", "△××□" and "SIXAXIS" are trademarks or registered trademarks of Sony Computer Entertainment Inc. "Blu-ray Disc" and "BD" are trademarks. © SEGA, SEGA, the SEGA logo, SEGA Rally, SEGA Superstars and SEGA Superstars Tennis are either registered trademarks or trademarks of SEGA Corporation. Published by SEGA. Developed by SUMO Digital Limited. Made in Austria. All rights reserved. This product contains software technology licensed from GameSpy Industries, Inc. © 1999-2003 GameSpy Industries, Inc. GameSpy and the "Powered by GameSpy" design are trademarks of GameSpy Industries, Inc. All rights reserved.

5060138435926